



SPORT GARDEN ENOIL



CATÁLOGO

2023 maquinaria y recambios

SPORT GARDEN

ENOIL



Estimado cliente:

Un año más, agradecemos la confianza depositada en nuestra empresa, que nos motiva a seguir esforzándonos en ofrecerles el mejor servicio, calidad y condiciones que usted se merece.

Grupo Ausavil se complace en anunciarle la nueva línea 2023, de nuestra marca **SPORT GARDEN y ENOIL**.

En estas páginas encontrará información detallada de nuestros productos, accesorios, consumibles y recambios, que esperamos le sirva de gran ayuda para realizar consultas técnicas acerca de nuestro producto.

Para este año 2023, hemos incluido muchas novedades que detallamos a continuación y que podrá identificar con la característica de **NUEVO** en nuestro catálogo.

Hemos incluido nuestra gama completa de la marca ENOIL.

GAMA FORESTAL:

- Nueva tijera de poda a batería.

GAMA JARDÍN:

- 2 nuevos modelos de desbrozadoras Kawasaki.

- 3 modelos de barra herbicida.

GAMA HUERTA:

- Modelo nuevo de motocultor.

GAMA CONSUMIBLES:

- Modelo nuevo de pantalla de protección.

En cuanto a las novedades de **ENOIL**, hemos actualizado la maqueta de depósitos para que resulte más intuitivo y sencillo completar con el equipamiento deseado.

**SOLUCIONES
PROFESIONALES
EN JARDÍN,
FORESTAL, HUERTA
CONSUMIBLE,
ENOLOGÍA Y
APICULTURA.**

Consulte más información y proyectos en nuestra web:

www.sportgardenausavil.es

o en www.ausavil.com

Gracias por confiar en nosotros.

*Atentamente,
Director general.*

Antonio Villar Costoyas

SPORT GARDEN



ENOIL



DIRECTOR GENERAL

ANTONIO VILLAR
antonio.villar@ausavil.com

DELEGADOS COMERCIALES

ALBERTO VILLAR
PONTEVEDRA/ OURENSE
(+34) 615 951 517
alberto.villar@ausavil.com

ALEXANDRE CAMIÑO
A CORUÑA/ LUGO / ISLAS BALEARES
(+34) 617 16 85 91
alexandre.camino@ausavil.com

EDUARDO MIGUELEZ
LEÓN / SALAMANCA / ZAMORA
(+34) 686 737 041
eduardo@emigueliez.es

JUAN JOSÉ MARTÍNEZ
CASTELLÓN / VALENCIA
(+34) 629 686 781
juanjomartinez@martinezquerol.com

FILIPE RIO
PORTUGAL (ZONA NORTE)
(+351) 934 454 289
filipe.rio@ausavil.com

PEDRO FERREIRA
PORTUGAL (ZONA CENTRO Y SUR)
(+351) 912 382 734
pedro.ferreira@ausavil.com

DELEGACIÓN OFICIAL AUSAVIL ZONA SUR
AGROINDUSTRIAL XENA
**ALICANTE/ ALMERÍA/ BADAJOZ/ CÁCERES/
CÁDIZ/ CÓRDOBA/GRANADA/ HUELVA/ JAEN/
MALAGA/ MURCIA/ SEVILLA**
(+34) 953 28 14 99
delegacionsur@agroindustrialxena.com

REPRESENTACIONES LLAMOSAS
ASTURIAS / CANTABRIA
DAVID: (+34) 683 176 823
JOSÉ ANTONIO: (+34) 699 475 250
representaciones@llamosas.es

ATENCIÓN AL CLIENTE

CALL CENTER **OTRAS COMUNIDADES**
(+34) 986 585 750
info@ausavil.com

COORDINADOR GENERAL

JOSÉ JESÚS GONZÁLEZ
(+34) 686 058 852
jose.gonzalez@ausavil.com

ADMINISTRACIÓN

YOLANDA RODRÍGUEZ
(+34) 681 356 750
administracion@ausavil.com

ALMACÉN

DIEGO MONTOUTO
(+34) 607 824 908
diego.montouto@ausavil.com

DIEGO CASTRO
(+34) 986 585 750
diego.castro@ausavil.com

MARKETING Y COMUNICACIÓN

SAMUEL VIDAL
(+34) 676 679 352
samuel.vidal@ausavil.com

SERVICIO POSTVENTA

ALEJANDRO IGLESIAS
(+34) 682 925 183
serviciopostventa@ausavil.com

SAT (Servicio de Asistencia Técnica)

JUAN JOSÉ SILVA
(+34) 628 560 670
juanjo.silva@ausavil.com

RECAMBIOS

SERGIO REQUEIJO
(+34) 986 585 750 / (+34) 696 863 953
sergio.requeijo@ausavil.com

OSCAR PISO
(+34) 986 585 750 / (+34) 696 863 953
oscar.piso@ausavil.com

AUSAVIL

custom-made machines

Somos AUSAVIL 2, S. L., nuestra empresa nace en el año 2002, dedicándose a la fabricación propia y venta al por mayor. Nuestro ánimo siempre ha sido, durante todos estos años, satisfacer cada demanda de nuestros clientes y esto nos ha llevado a adquirir experiencia y el conocimiento de producto necesarios para realizar el proceso de fabricación completo.

En nuestras instalaciones comenzamos por el diseño del producto, realizamos la búsqueda y elección de las piezas más adecuadas para la fabricación de nuestros diseños, nos ocupamos del montaje y prueba de las máquinas y finalmente de la distribución al por mayor.

Dentro de la empresa contamos con 5 marcas propias:

- **STARK (somos fabricantes de equipos profesionales de limpieza como son hidrolimpiadoras, equipos contra incendios, etc)**
- **SPORT GARDEN (aportamos soluciones profesionales en jardín, forestal, huerta y consumibles)**
- **ENOIL (destacamos por ser fabricantes de depósitos de acero inoxidable a medida y aportamos soluciones profesionales en oleomaquia y apicultura)**
- **STARK VILL (fabricantes de producto químico)**
- **STARK BOX (destacamos por ser fabricantes de boxes de lavado y aspirado).**

Comenzamos distribuyendo los productos en toda España y Portugal. Durante nuestros más de 20 años de trabajo hemos construido una red de distribución amplia y sólida que se incrementa cada día y que recibe atención profesional de cada uno de nuestros comerciales. Esta red de distribución de nuestros productos incluye desde el retailer hasta las grandes superficies y cooperativas de compras profesionales.

Siguiendo la demanda de nuestros productos hemos creado un nuevo departamento que nos ayuda en nuestro objetivo de mantener una posición top en el mercado: el departamento de exportación. Nuestros compañeros han conseguido que nuestros productos se vendan con éxito en numerosos países de la UE, África y Sudamérica y hemos afianzado nuestro posicionamiento en estos países. El objetivo de esta presentación es que tenga una visión global de nuestra empresa, conociendo a qué nos dedicamos, cómo lo hacemos y cuál es el resultado.

Nuestra filosofía de fabricación nos permite controlar todo el proceso completo, desde las materias primas hasta el producto final. Utilizamos técnicas de producción para que todo el proceso sea eficiente y lograr una competitividad en el mercado. Construimos productos de calidad y duración combinados con una buena tecnología y que cumple los estándares de calidad y la exigencia de nuestro cliente.

Puede obtener más información en nuestra página web del grupo; www.ausavil.com o en nuestras webs de marca: www.starkausavil.es o www.sportgardenausavil.es y quedamos a su disposición para aclarar cualquier tipo de duda que pueda surgirle al respecto.



Oficinas y almacén (Matalobos-A Estrada).



Fábrica (Matalobos-A Estrada).

FORESTAL 8

TIJERAS DE PODA Y MINIMOTOSIERRAS 9

TIJERA PODA 16.8 25 9
 TIJERA PODA 500W 11
 TIJERA PODA CABLE 12
 MINIMOTOSIERRA 13
 MOTOSIERRA BATERÍA 14
MOTOSIERRAS 15
 SG-M 2500 15
 CS 2520 16
 CS 38T 17
 SG-M 5950 18
BIOTRITURADORES 19
 SG BIOT6.5HP 19
 SG BIOT15HPAE PRO 20
 SG PRO BIOT15HPAE 21
 SG BIOT HD 22
ASTILLADORAS 23
 SG AS 7T 23
 SG AS 12 TG 24
 SG AS 12 TE 25
 SG AS 22T 26
 SG HV46 5L 27
 SG HV46 20L 27

JARDÍN 28

DESBROZADORAS 29

SG-DESBROZADORA 4 T 43 29
 SG 508 30
 SPORTGARDEN 62 31
 SG-DMULTI 330 32
 DGREEN 52 33
 SG-TJ45E 34
 SG-TJ53E 35
 SPORTGARDEN TJ45 N 36
 SPORTGARDEN TJ53 N 37

VAREADORES 38

SG VAREADOR PODADORA 38
 SG VAREADOR 39

AHORADORES 40

SG AHOYADOR 508 40
 SG AHOYADOR 520 40

CORTACÉSPEDES 41

SG 3610 AU 41
 SG CH 460 41
 GT 42 42
 SG CORTACESPED 48 SLT 43
 SG CORTACESPED 51 SLT 44
 SG CORTACESPED 53 SLT 45
 WY28XE11BS 46
 WYZ50XL 48

CORTASETOS 50

SPORTGARDEN 234T 50
 SG-CORTASETOS 600 51

SOPLADORES 52

SG EB 800 52
 SG EBV 260 53

PULVERIZACIÓN 54

SG SULFATADORA BAT/MAN 54
 SG 16D 55
 SG P60T 56
 SG CARRETILLA 2T 57
 603+AI154 57
 9150480840000 57
 SG CARRETILLA 4T 58
 603+AI154 58
 9150480840000 58
 SG CARRETILLA 2R 4T 59
 603+AI154 59
 9150480840000 59
 AI206 60
 AI207 60
 AI201 61
 C26V14E570 61
 615101 61
 615101 61
MOTOBOMBAS 62
 ST 10A SP 62

ST 15B SP 63
 ST 20A SP 64
 ST 30A SP 65
 ST 15AR 75 SP - PRESIÓN 75 M 66
BOMBAS 67
 BJ 45/75 67
 JET 100A 67
 AJ 50/60 68
 IPC 550 68
 IP 750 69
 IP 1100 69
 IP 750 INOX 70
 IP 1100 INOX 70
 MULTI IP 1000 INOX 71
 MULTI IP 1200 INOX 71
 OLA INOX 60/60 72
 OLA INOX 70/100 72
 SWQ 1300 73
 PC-SK2 (PRESOSTATO) 74
 BOMBA PISCINA 74
 DEPÓSITO 24 L 75
 PC - 15 (AUTÓMATA BOMBA) 75
 TUBO 50 CM 75
HIDROLIMPIADORAS 76
 SGH 130 76
 SGH 150 77
 SGFD 152/9 78
 SGFD 206/13 INOX 79
 SGH 207/10 80
 SGFD 247/17 81

HUERTA 82

MOLINO DE GRANO 83

MBIDON 50 INOX 83
 MBIDON 50 83
 9042430- MOTOR MBIDON 84
 AI038- CUCHILLA MBIDON 84
 XSDZ-6C INTERRUPTOR MBIDON 84
 CRIBA MBIDON 84

DESGRANADORES 85

DESGRANADOR 85
 DESGRANADOR 85

MOTOAZADAS 86

MZ500S 86
 MZ500H 86

APEROS MOTOAZADAS 87

KIT COMPLETO MZ500S 87
 T0304002 87
 T0304003 87
 R-400.8 87
 SEP RMZ500 87
 110003 MZ500 87
 MZ700S1 88
 MZ700H 88
 SG400012 89
 SG400011 89
 R-500.10 89
 AS-1 90
 M26B 90
 PT-1 90

MOTOCULTORES 91

MTCMINIGASOLINA 91
 MTC DIESEL AE 92
 MTC LONCIN GASOLINA AE 93

APEROS MOTOCULTORES 94

AVG MTC 94
 AV MTC 94
 AR MTC 95
 TRITURADORA MTC 95
 BS MTC 96
 ENGANCHE RÁPIDO MTC 96
 MB12N 96
 APVDOB 97
 CONTRAPESO 500-10 MTC 17 97
 CONTRAPESO 500-10 MTC 34 97
 ENGANCHE APERO MTC 97
MINITRANSPORTERS 98
 SG MINITRANSPORTER 300 98
 SG MINITRANSPORTER H 300 99

| | |
|----------------------------|-----|
| SG MINITRANS 500 | 100 |
| SG MINITRA 500 HONDA | 101 |
| SG MINITRANS 500 HID | 102 |
| SG MINIT 500 HID HON | 103 |
| SG MINITRANS PALA | 104 |

CONSUMIBLES.....106

LIMAS DE CADENA Y ACCESORIOS.....107

| | |
|---------------------|-----|
| SG40000031364Q..... | 107 |
| SG400000345Q..... | 107 |
| SG4000003732Q..... | 107 |

AFILADORES DE CADENA.....107

| | |
|---------------|-----|
| SG30501 | 107 |
| SG 220S..... | 108 |
| SG 230SA..... | 108 |

CABALLETE MOTOSIERRA.....108

| | |
|---------------|-----|
| AU001464..... | 108 |
|---------------|-----|

CANENA MOTOSIERRA.....109

| | |
|--------------------------|-----|
| SG 3/8LP | 109 |
| SG 325050 | 109 |
| SG 325058 | 109 |
| SG 3/8..... | 109 |
| SG 325063..... | 109 |
| SG 325050 C..... | 109 |
| SG 325058 C..... | 109 |
| SG 3/8 C..... | 109 |
| SG 3/8063..... | 109 |
| REMACHES CADENA..... | 109 |
| SG 3/8 LP 043 WIDEA..... | 110 |
| SG 3/8 LP WIDEA..... | 110 |
| SG 3/8 058 WIDEA..... | 110 |
| SG 325050 WIDEA..... | 110 |
| SG 325058 WIDEA..... | 110 |
| REMACHES CADENA..... | 110 |
| SG BR001..... | 112 |
| SG SP001..... | 112 |

ACEITE.....113

| | |
|-------------------------|-----|
| SG GRASA..... | 113 |
| SG 2T.OIL 125..... | 113 |
| SG 2T SINTÉTICO 1L..... | 113 |
| SG 2T OIL 1D..... | 113 |
| SG 2T OIL 5L..... | 114 |
| SG 4T SINTÉTICO 1L..... | 114 |
| SG 4T.OIL 5..... | 114 |
| SG CS.OIL 5..... | 114 |

DISCOS.....115

| | |
|--------------|-----|
| 6520E/A..... | 115 |
| 6522/A..... | 115 |
| 6528E..... | 115 |
| 6527E..... | 115 |
| 6521E/A..... | 115 |
| 6530/A..... | 115 |
| 6528..... | 115 |
| 6520/A..... | 115 |
| 6526/A..... | 115 |
| 6521/A..... | 115 |
| 6527..... | 115 |
| 6525/A..... | 116 |
| 6001/A..... | 116 |
| 6001E/A..... | 116 |
| 6524/A..... | 116 |
| 6523/A..... | 116 |
| 6501/A..... | 116 |
| 6501E/A..... | 116 |
| 6529/A..... | 116 |
| 6013/A..... | 116 |
| 6044..... | 116 |
| 6013E/A..... | 116 |
| 6002/A..... | 116 |
| 6059..... | 116 |
| 6004E/A..... | 117 |
| 6504..... | 117 |
| 6038..... | 117 |
| 6003E/A..... | 117 |
| 6003/A..... | 117 |
| 6507..... | 117 |
| 6039..... | 117 |

| | |
|-------------|-----|
| 6004/A..... | 117 |
|-------------|-----|

DISCOS OEM.....118

| | |
|-----------------|-----|
| 6501OEM..... | 118 |
| 6194OEM..... | 118 |
| 6002OEM..... | 118 |
| 6013OEM..... | 118 |
| 6195OEM..... | 118 |
| 6521OEM..... | 118 |
| 6042OEM..... | 118 |
| 6004OEM..... | 118 |
| 6048OEM..... | 118 |
| 6520OEM..... | 118 |
| 2520..... | 119 |
| 6524OEM..... | 119 |
| 6081OEM..... | 119 |
| 2525..... | 119 |
| 6525OEM..... | 119 |
| 6523OEM..... | 119 |
| 2520/A..... | 119 |
| 6082OEM..... | 119 |
| 2525/A..... | 119 |
| 6522OEM..... | 119 |
| 3620 255/A..... | 120 |
| 40255 20/A..... | 120 |
| 2420/A..... | 120 |
| 3625 255/A..... | 120 |
| 40255 25/A..... | 120 |
| 2425/A..... | 120 |

CABEZALES Y ACCESORIOS.....121

| | |
|--|-----|
| SG CEPILLO Ø200..... | 121 |
| GH02 1006..... | 122 |
| GH02 1007- SPEED MONTAJE C/GIRO IZQ..... | 122 |
| PD001..... | 122 |
| PD004..... | 122 |
| SG30011..... | 122 |
| GH02 20056..... | 123 |
| GH02 20056 TL..... | 123 |
| GH02 20001..... | 123 |
| GH02 20050..... | 124 |
| GH02 20060..... | 124 |
| GH02 2240..... | 124 |
| 50719296..... | 124 |
| 50719297..... | 124 |
| 50719298..... | 124 |
| 50719299..... | 124 |
| 50719200..... | 124 |
| 50719110..... | 124 |
| GH02 3209..... | 125 |
| GH02 2239..... | 125 |
| GH02 1201..... | 125 |
| 5073901..... | 125 |
| 5073902..... | 125 |
| 5073903..... | 125 |
| 5073904..... | 125 |
| 5073908..... | 125 |
| GH02 10125..... | 126 |
| 10125-1..... | 126 |
| 10125-2..... | 126 |
| 10125-3..... | 126 |
| 10125-4..... | 126 |
| 10125-5..... | 126 |
| GH02 2239..... | 127 |

ARNESES.....128

| | |
|--------------------|-----|
| JDSH-01..... | 128 |
| CP H2628W..... | 128 |
| ERGO ARNES EC..... | 128 |
| ERGO ARNES..... | 129 |

CASCOS Y PANTALLAS DE PROTECCIÓN.....129

| | |
|-----------------|-----|
| CS 40043..... | 129 |
| PC 20073..... | 129 |
| PC 453 319..... | 130 |
| GT 20077..... | 130 |
| PC 20077..... | 130 |

GUANTES DE PROTECCIÓN.....131

| | |
|---------------------------|-----|
| GUANTE ANTICOR 21 M..... | 131 |
| GUANTE ANTICOR 21 L..... | 131 |
| GUANTE ANTICOR 21 XL..... | 131 |

CASCOS, ESPINILLERAS Y ZAHONES.....132

| | |
|-----------------|-----|
| PO 453 321..... | 132 |
| SG KNEP..... | 132 |

| | |
|------------------------------------|------------|
| SG 6411 | 132 |
| SG 6420 (CLASE 2) | 132 |
| BIDONES DE COMBUSTIBLE..... | 140 |
| B50080..... | 140 |
| B50079 VISOR..... | 140 |
| B50078 VISOR..... | 140 |
| B50077..... | 140 |
| B50079 TRANSPARENTE..... | 141 |
| B50078 TRANSPARENTE..... | 141 |
| BIDONES METÁLICOS..... | 141 |
| SG-L5..... | 141 |
| SG-L20..... | 141 |
| MERCHANDASING..... | 142 |
| CHAQUETA ACOLCHADA..... | 142 |
| POLO SPORTGARDEN..... | 142 |
| CHALECO DE TRABAJO..... | 142 |
| CHALECO SPORTGARDEN..... | 142 |
| CAMISA SPORTGARDEN..... | 142 |
| BATA DE TRABAJO..... | 142 |
| MOCHILA SPORTGARDEN..... | 143 |
| LINEAL DE EXPOSICIÓN..... | 143 |
| BANDERA PUBLICITARIA..... | 143 |
| PANEL FOTOGRÁFICO PVC..... | 143 |
| CUBO PEQUEÑO..... | 144 |
| PARAGUAS SG..... | 144 |
| CUBO GRANDE..... | 144 |

| | |
|---------------------------|------------|
| RECAMBIOS..... | 145 |
| ■ BATERÍAS..... | 146 |
| ■ CORTACÉSPED..... | 149 |
| ■ DESBROZADORA..... | 156 |
| ■ HERRAMIENTAS..... | 164 |
| ■ LIMPIEZA..... | 168 |
| ■ MOTORES..... | 172 |
| ■ MOTORES ELÉCTRICOS..... | 219 |
| ■ MOTOSIERRAS..... | 221 |
| ■ PULVERIZACIÓN..... | 243 |
| ■ VAREADORES..... | 246 |

ENOLOGÍA.....249

| | |
|---|------------|
| PELADORAS..... | 250 |
| PELADORA E..... | 250 |
| PELADORA G..... | 250 |
| TINAJAS Y TAPAS..... | 251 |
| TINAJAS DE POLIETILENO PE.HD..... | 251 |
| TAPA..... | 251 |
| GRIFOS Y EMBUDOS..... | 252 |
| GPP 4562 421..... | 252 |
| EMBUDO POLIETILENO C/SOPORTE PARA FILTRO..... | 252 |
| EMPE 22..... | 252 |
| EMPE 26..... | 252 |
| FFT 550 204..... | 252 |
| EMPE 30..... | 252 |
| EMPE 35..... | 252 |
| FILTROS..... | 253 |
| FILTEMB 22..... | 253 |
| FILTEMB 26/35..... | 253 |
| BIDÓN CON GRIFO - FABRICADO EN ELTEX..... | 253 |
| BIDÓN CON GRIFO - FABRICADO EN ELTEX..... | 253 |
| DEPOSITOS BIDÓN PARA TRANSPORTE..... | 254 |
| DEPÓSITO-BIDÓN PARA TRANSPORTE (SOLDADO)..... | 254 |
| DEPÓSITO-BIDÓN PARA TRANSPORTE (AGRAFADO)..... | 255 |
| GRIFOS..... | 255 |
| GRIFO 1/2 " L ECON..... | 255 |
| GRIFO 1/2 "INOX A..... | 255 |
| DEP. FLOREADOS INOX 304 E SERIE "ECO"..... | 256 |
| DEP. FLOREADOS INOX 304 E SERIE "ECO"..... | 256 |
| DEP. FLOREADOS INOX 304..... | 258 |
| DEP. FLOREADOS INOX 304..... | 258 |
| DEP. FLOREADOS INOX 316..... | 259 |
| DEP. FLOREADOS INOX 316..... | 259 |

| | |
|--|------------|
| TRÍPODE PARA DEPÓSITOS SERIE ECO ACERO INOX..... | 260 |
| TRÍPODE PARA DEPÓSITOS SERIE ECO ACERO INOX..... | 260 |
| DEP. FLOREADOS INOX | |
| C/FONDO CÓNICO Y PATAS 304..... | 260 |
| DEP. FLOREADOS INOX | |
| C/FONDO CÓNICO Y PATAS 304..... | 260 |
| DEP. CERRADO C/TAPÓN SUPERIOR..... | 262 |
| DEP. CERRADO C/TAPÓN SUPERIOR..... | 262 |
| DEP. CERRADO C/PUERTA SUPERIOR..... | 262 |
| DEP. CERRADO C/PUERTA SUPERIOR..... | 262 |
| DEP. CERRADO C/PUERTA INFERIOR (APERT. INT.)..... | 263 |
| DEP. CERRADO C/PUERTA INFERIOR (APERT. INT.)..... | 263 |
| DEP. CERRADO C/PUERTA INFERIOR (APERT. EXT.)..... | 263 |
| DEP. CERRADO C/PUERTA INFERIOR (APERT. EXT.)..... | 263 |
| DEP. CERRADO 2 PUERTAS..... | 264 |
| DEP. CERRADO 2 PUERTAS..... | 264 |
| DEP. CERRADO FONDO CÓNICO..... | 266 |
| DEP. CERRADO FONDO CÓNICO..... | 266 |
| DEP. CERRADO FONDO CÓNICO/CAMISA..... | 267 |
| DEP. CERRADO FONDO CÓNICO/CAMISA..... | 267 |
| DEP. SIEMPRE LLENO FONDO CÓNICO..... | 268 |
| DEP. SIEMPRE LLENO FONDO CÓNICO..... | 268 |
| DEP. SIEMPRE LLENO FONDO CÓNICO/CAMISA..... | 269 |
| DEP. SIEMPRE LLENO FONDO CÓNICO/CAMISA..... | 269 |
| DEP. CERRADO FONDO PLANO INCLINADO 5%..... | 270 |
| DEP. CERRADO FONDO PLANO INCLINADO 5%..... | 270 |
| DEP. CERRADO FONDO | |
| PLANO INCLINADO 5% /CAMISA..... | 271 |
| DEP. CERRADO FONDO | |
| PLANO INCLINADO 5% /CAMISA..... | 271 |
| DEP. SIEMPRE LLENO FONDO PLANO INCLINADO..... | 272 |
| DEP. SIEMPRE LLENO | |
| DEP. SIEMPRE LLENO FONDO PLANO INCLINADO..... | 272 |
| DEP. SIEMPRE LLENO | |
| FONDO PLANO INCLINADO/CAMISA..... | 273 |
| FONDO PLANO INCLINADO/CAMISA..... | 273 |
| TAPA DE ACEITE..... | 274 |
| TAPA DE ACEITE..... | 274 |
| TAPA DE POLVO..... | 274 |
| TAPA DE POLVO..... | 274 |
| TAPA NEUMÁTICA..... | 275 |
| TAPA NEUMÁTICA..... | 275 |
| CÁMARAS DE PLÁSTICO TRANSPARENTE..... | 276 |
| CÁMARAS DE PLÁSTICO TRANSPARENTE..... | 276 |
| COMPLEMENTOS DEPÓSITOS..... | 276 |
| 00500..... | 277 |
| VEDE2"..... | 277 |
| 00701..... | 277 |
| VAL 1" 1/4..... | 277 |
| 02501..... | 278 |
| VAL 1"1/2..... | 278 |
| FA 309092702..... | 278 |
| ARS..... | 278 |
| GRIFO LATÓN NIQUELADO..... | 280 |
| GRIFO ACERO INOXIDABLE..... | 280 |
| VÁLVULA DE ESFERA LATÓN..... | 280 |
| GRIFO 1/2 "INOX A..... | 280 |
| VÁLVULA DE ESFERA ACERO INOXIDABLE..... | 281 |
| TERW 120D63..... | 281 |
| TD00010..... | 281 |
| MOS 0982..... | 282 |
| REFR PMTC-25..... | 282 |
| DEN 1695..... | 283 |
| ALCO 01672..... | 283 |
| VIN 0986..... | 283 |

| | |
|---|------------|
| ALAMBIQUES..... | 284 |
| ALAMBIQUES..... | 284 |
| FILTRO COLOMBO..... | 285 |
| FILTRO COLOMBO..... | 285 |
| PLACAS FILTRANTES 20X20..... | 285 |
| PLACAS FILTRANTES 20X20..... | 285 |
| FILTRO JOLLY..... | 286 |
| FILTRO JOLLY..... | 286 |
| PLACAS FILTRANTES 40X40..... | 286 |
| ELECTROBOMBAS..... | 287 |
| ELECTROBOMBAS..... | 287 |
| PISTOLA DISPENSER..... | 289 |
| PISTOLA DISPENSER..... | 289 |
| CONTADOR DE VINO..... | 289 |
| CMV 003702..... | 289 |
| LLENADORA AUTOMÁTICA..... | 289 |
| ENOLMATIC..... | 289 |
| EMBOTELLADORES..... | 290 |
| EMBOTELLADORA BAJA INOX..... | 290 |
| EMBOTELLADORA ALTA INOX..... | 291 |
| EMBOTELLADORA ALTA INOX..... | 292 |
| EMBOTELLADORA ALTA INOX..... | 293 |
| ENCORCHADORAS..... | 294 |
| EDH 750003..... | 294 |
| ETP 753801..... | 295 |
| MOLINO DE ACEITUNA..... | 297 |
| MOLINO PR 25..... | 297 |
| PIE MOLINO ACEITUNA..... | 297 |
| PRENSA HIDRÁULICA..... | 297 |
| OLEUM 50..... | 297 |
| PRENSAS..... | 298 |
| CAPACHETA DE POLIPROPILENO..... | 298 |
| DEPÓSITOS PARA ACEITE..... | 299 |
| DEPÓSITOS FLOREADOS PARA ACEITE INOX 304..... | 299 |
| DEPÓSITOS FLOREADOS INOX 304 E SERIE "ECO"..... | 300 |
| DEPÓSITOS FLOREADOS PARA ACEITE INOX 316..... | 302 |
| DEPÓSITOS DECANTACIÓN PARA ACEITE INOX 304..... | 303 |
| DEPÓSITOS FLOREADOS PARA ACEITE INOX 304..... | 304 |
| FILTROS..... | 304 |
| PLACAS FILTRANTES 20X20..... | 307 |
| EMBOTELLADORA ALTA INOX..... | 307 |
| DEPOSITOS PARA MIEL..... | 309 |
| DEPÓSITOS FLOREADOS PARA MIEL EN INOX 304..... | 309 |
| TRÍPODES PARA DEPÓSITOS PARA MIEL EN INOX..... | 309 |
| TRÍPODES PARA DEPÓSITOS PARA MIEL EN INOX..... | 309 |



TIJERAS DE PODA
MINIMOTOSIERRAS DE PODA
MOTOSIERRAS
BIOTRITURADORES
ASTILLADORAS
ACEITE HIDRÁULICO

FORESTAL





NUEVO

TIJERA PODA 16.8 25

tijera de poda

| | |
|---------------------------------------|------------------------|
| Voltaje | 16,8 V / 2 Ah |
| Frecuencia nominal | 50 HZ / 60HZ |
| Diámetro de corte | 35 mm / 15 mm |
| Potencia | 500 W |
| Motor | sin escobillas |
| Hoja | SK5 |
| Peso tijera | 0,860 Kg |
| Peso batería | 0,220 Kg |
| Duración batería | 4 horas / 4.000 cortes |
| Tiempo de carga | 2 - 2,5 horas |
| Peso total con equipamiento y maletín | 1,6 kg |

INCLUYE 1 BATERÍA + CARGADOR

EQUIPAMIENTO OPCIONAL



Batería adicional
Ref: **310622050011**



| REFERENCIA | DESCRIPCIÓN |
|--------------|-------------------|
| 310622050015 | CUCHILLA FIJA |
| 310622050016 | CUCHILLA FLOTANTE |
| 310622050011 | BATERÍA |
| 310622050029 | CARGADOR |



1x cargador



1x batería



1x maletín





TIJERA PODA 500W

tijera de poda

| | |
|--------------------|-------------------|
| Voltaje | 21 V / 2,5 Ah |
| Frecuencia nominal | 50 HZ / 60HZ |
| Diámetro de corte | 35 mm / 15 mm |
| Potencia | 500 W |
| Motor | sin escobillas |
| Hoja | Suiza C75 |
| Peso tijera | 1,080 Kg |
| Peso batería | 0,280 Kg |
| Duración batería | 4 h / 4000 cortes |
| Tiempo de carga | 2/2,5 h |

BMS para gestión de batería

Peso total con equipamiento y maletín 3,780 Kg

HOJA SUIZA C75
Especial por su dureza y eficacia



INCLUYE 3 BATERÍAS + CARGADOR

| REFERENCIA | DESCRIPCIÓN |
|---------------|-------------------|
| 3040100020000 | CUCHILLA INFERIOR |
| 3040100030000 | CUCHILLA SUPERIOR |
| 3600089898211 | BATERÍA |





TIJERA PODA CABLE

tijera de poda de cable

| | |
|---------------------------------------|-------------------------|
| Voltaje | 43.2V / 2,5 Ah |
| Frecuencia nominal | 50 HZ / 60HZ |
| Diámetro máx. de corte | 40 mm |
| Motor | sin escobillas |
| Potencia | 1200 W |
| Hoja | Suiza C75 |
| Peso tijera | 0,870 kg |
| Peso batería | 1,5 Kg |
| Duración batería | 8 h / 4000 cortes aprox |
| Tiempo de carga | 2/2,5 h |
| BMS para gestión de batería | |
| Peso total con equipamiento y maletín | 5,5 Kg |

PROTECCIÓN DE CORTE
Detecta los dedos de la mano sin guantes y se bloquea para no producir cortes.



PANTALLA LED

Muestra el tiempo de corte.
Voltaje de la batería.
Tiempo de carga.

INCLUYE 1 BATERÍA + CARGADOR

| REFERENCIA | DESCRIPCIÓN |
|---------------|---------------------------|
| 310011080006 | BATERIA TIJERA PODA CABLE |
| 3040100000700 | CUCHILLA INFERIOR |
| 3040000000700 | CUCHILLA SUPERIOR |





MINIMOTOSIERRA

minimotosierra

| | |
|---------------------------------------|------------------|
| Voltaje | 21 V / 4 Ah |
| Potencia nominal | 600 W |
| Velocidad cadena | 12 m/s |
| Paso de cadena | 1/4 " (6,35) |
| Saltador de cadena | 7 |
| Tanque de aceite | 130 ml |
| Motor | sin escobillas |
| Peso motosierra sin batería | 1,89 Kg |
| Batería | Batería de litio |
| Peso batería | 0,580 Kg |
| Duración batería | 2 h / 400 cortes |
| Tiempo de carga | 2/2,5 h |
| BMS para gestión de batería | |
| Peso total con equipamiento y maletín | 4,3 Kg |



INCLUYE 1 BATERÍA + CARGADOR

| REFERENCIA | DESCRIPCIÓN |
|----------------|-------------|
| 45689752312523 | BATERÍA |
| KHMS00000001 | CADENA |
| KHDS00000001 | SABLE |



1x cargador



1x batería





MOTOSIERRA BATERÍA

motosierra

| | |
|-----------------------------|------------------------------------|
| Voltaje | 21 V, 2,5 Ah |
| Tasa de potencia | 500 W |
| Velocidad cadena | 11 m/s |
| Paso de cadena | 1/4 " (6,35) |
| Depósito aceite | 130 ml |
| Motor | sin escobillas |
| Freno de cadena | mecánico |
| SDS | Tensado de cadena sin herramientas |
| Luz led | indicadora de trabajo |
| Duración de batería | 2 h / 200 cortes aprox |
| Tiempo de carga | 2 / 2,5 h |
| BMS para gestión de batería | |
| Engrase manual | |

INCLUYE 2 BATERÍAS + CARGADOR



| REFERENCIA | DESCRIPCIÓN |
|---------------|-------------|
| 3020721030000 | CADENA |
| 2200100080000 | SABLE |
| 3600089898211 | BATERÍA |





SG-M 2500

motosierra de poda

| | | | |
|-------------------|-----------------------------|---------------------------|------------------|
| Carburador Walbro | Freno de cadena por inercia | Sistema de arranque fácil | Tensor de cadena |
|-------------------|-----------------------------|---------------------------|------------------|

| | |
|--------------------|--------------------|
| Motor | Gasolina 2 tiempos |
| Cilindrada | 25,4 cc |
| Longitud de espada | 30 cm / 12" |
| Paso | 3/8" BP |
| Galga | 0,50" |
| Eslabones | 45 |
| Peso | 2,9 kg |



| REFERENCIA | DESCRIPCIÓN |
|-------------------------------------|--------------------|
| SG.CM. 3/8.BP.45E | RECAMBIO CADENA |
| TT-CS2500A-A6 | FILTRO COMBUSTIBLE |
| TT-CS2500A-A7 | RESPIRO |
| TT-CS2500A-A31 | TAPAS CLIPS PISTON |
| TT-CS2500A-A32 | CLIPS PISTON |
| TT-CS2500A-A33 | PISTON |
| TT-CS2500A-A34 | AROS |
| TT-CS2500A-A35 | BULON |
| TT-CS2500A-A37 | BOBINA |
| TT-CS2500A-A42 | JUNTA ADMISION |
| TT-CS2500A-A51 | BOMBA ACEITE |
| TT-CS2500A-B3 /4/5/6/7/8/9/10/11 | ARRANQUE COMPLETO |
| TT-CS2500A-B22 | INTERRUPTOR |

| | |
|---|--------------------------------|
| TT-CS2500A-B28 | FILTRO DE AIRE |
| TT-CS2500A-B32 | CARBURADOR |
| TT-CS2500A-B33 | TIRADOR AIRE |
| TT-CS2500A-B35/ 36/37/38 /39/40/41/42/ 43/44/45/46/ 47/48/49/50 /51/52/53/54 | FRENO COMPLETO |
| TT-CS2500A-B55/56 | TENSOR CADENA |
| TT-CS2500A-B60 | EMBRAGUE |
| TT-CS2500A-B62 | CAMPANA EMBRAGUE |
| TT-CS2500A-B63 | CADENA DE SERIE |
| TT-CS2500A-B64 | RODAMIENTO CAMPANA EMBRAGUE |
| TT-CS2500A-B65 | SABLE |

Descripción y usos: sus 2,9 kg de peso el diseño de su empuñadora y su eficaz sistema antivibración así como su reducido tamaño permiten realizar un trabajo rápido y eficaz cuando se trata de poda y trabajos en casa, incluso manejandola con una sola mano.



CS 2520

motosierra

| | | | |
|-------------------|-----------------------------|---------------------------|------------------|
| Carburador Walbro | Freno de cadena por inercia | Sistema de arranque fácil | Tensor de cadena |
|-------------------|-----------------------------|---------------------------|------------------|

| | |
|--------------------|--------------------|
| Motor | Gasolina 2 Tiempos |
| Cilindrada | 49,3 cc |
| Longitud de espada | 45 cm / 18" |
| Paso | 325" |
| Galga | 0.58" |
| Eslabones | 72 |
| Peso | 5 kg |



| REFERENCIA | DESCRIPCIÓN |
|-------------------|---------------------------|
| SG.CM.325 058.72E | RECAMBIO CADENA |
| CS520057-65 | TENSOR CADENA |
| CS5200N12-9 | ARRANQUE COMPLETO |
| CS5200N29-30 | TAPON GASOLINA |
| CS5200N35 | INTERRUPTOR |
| CS5200N36 | CEBADOR |
| CS5200N42 | FILTRO GASOLINA |
| CS5200N68 | CADENA DE SERIE |
| CS5200N69 | SABLE |
| CS5200NA14 | JUNTA CILINDRO |
| CS5200NA15 | AROS PISTON |
| CS5200NA16 | PISTON |
| CS5200NA17 | CLIP PISTON |
| CS5200NA18 | BULON |
| CS5200NA20 | RODAMIENTO SUPERIOR BIELA |
| CS5200NA25-27 | TAPON ACEITE |
| CS5200NA56 | FILTRO AIRE |
| CS5200NA58 | TIRADOR AIRE |
| CS5200NA64 | ENGRANAJE ENGRASE |
| CS5200NA67-70 | EMBRAGUE |
| CS5200NA73 | BOMBA DE ENGRASE |
| CS5200NA49 | CARBURADOR |

Descripción y usos: esta motosierra es ideal para uso doméstico, labores de casa, trabajos esporádicos, etc. Muy práctica y económica para cortar los troncos para chimenea, podar las ramas o leñas, embellecer su jardín.



CS 38T

motosierra

| | | | |
|-------------------|-----------------------------|---------------------------|------------------|
| Carburador Walbro | Freno de cadena por inercia | Sistema de arranque fácil | Tensor de cadena |
|-------------------|-----------------------------|---------------------------|------------------|

| | |
|--------------------|--------------------|
| Motor | Gasolina 2 tiempos |
| Cilindrada | 37,2 cc |
| Longitud de espada | 40 cm / 12" |
| Paso | 3/8" BP |
| Galga | 0,50" |
| Eslabones | 55 |
| Peso | 4,6 kg |



| REFERENCIA | DESCRIPCIÓN |
|------------------|--------------------------|
| SG.CM.3/8.BP.55E | RECAMBIO CADENA |
| 2670-34401 | TAPON GASOLINA |
| 2877-31800 | TAPON ACEITE |
| 2850-74102 | INTERRUPTOR |
| 2850-82411 | TIRADOR AIRE |
| 2939-52110-50 | SABLE |
| 848C405121 | EMBRAGUE COMPLETO |
| 848C435301 | FRENO |
| 848C487500 | ARRANQUE |
| 848CA20604 | BOMBA DE ACEITE COMPLETA |
| 2850-83100 | FILTRO AIRE |
| 1850-85300 | FILTRO GASOLINA |
| T2100-81001 | CARBURADOR |
| T2100-71200 | BOBINA |
| 848CA20604 | BOMBA DE ACEITE COMPLETA |
| 2850-41310 | BULON |
| T2100-41110 | PISTON |
| 2850-14212 | JUNTA CILINDRO |
| 2850-41310 | BULON |
| T2100-41210 | KIT AROS |

| | |
|-------------|-------------------|
| 1300-41320 | KIT CLIPS PISTON |
| T2100-41410 | RODAMIENTO PISTON |
| T2100-52220 | TUERCA TENSOR |
| T2100-53220 | TORNILLO TENSOR |

Descripción y usos: potente motor de 2T. 37,2 cc. y con una longitud espada de 40 cm. Es el equipo adecuado para todo tipo de trabajo para la poda de árboles y troncos, es especialmente adecuada para preparar cortar la leña y a su vez mantener el jardín perfecto.



SG-M 5950

motosierra

| | | | |
|-------------------|-----------------------------|---------------------------|------------------|
| Carburador Walbro | Freno de cadena por inercia | Sistema de arranque fácil | Tensor de cadena |
|-------------------|-----------------------------|---------------------------|------------------|

| | |
|--------------------|--------------------|
| Motor | Gasolina 2 Tiempos |
| Cilindrada | 59,8 cc |
| Longitud de espada | 51 cm / 20" |
| Paso | 325" |
| Galga | 0.58" |
| Eslabones | 78 |
| Peso | 7,5 kg |



| REFERENCIA | DESCRIPCIÓN |
|-------------------|-------------------|
| SG.CM.325 058.78E | RECAMBIO CADENA |
| SGM5950-2/13 | ARRANQUE COMPLETO |
| SGM5950-14/16 | TAPON GASOLINA |
| SGM5950-44 | FILTRO DE AIRE |
| SGM5950-27 | FILTRO GASOLINA |
| SGM5950-41 | PALANCA FRENO |
| SGM5950-51/68 | FRENO |
| SGM5950-43 | INTERRUPTOR |
| SGM5950-70 | SABLE |
| SGM5950-71 | CADENA DE SERIE |
| MSGM5950-26 | ANILLO SUP BIELA |
| MSGM5950-27 | RODAMIENTO PISTON |
| MSGM5950-28 | CLIP PISTON |
| MSGM5950-29 | PISTON |
| MSGM5950-30 | BULON |
| MSGM5950-31 | AROS |
| MSGM5950-32 | JUNTA CILINDRO |
| MSGM5950-43 | BOBINA |
| MSGM5950-52 | CARBURADOR |
| MSGM5950-60 | TIRADOR AIRE |
| MSGM5950-70 | BOMBA ACEITE |

Descripción y usos: profesional resistente y potente perteneciente a la clase de 60cc. Para todo tipo de usuarios que requieren una gran potencia, especialmente para talar y cortar dimensiones complicadas.



SG BIOT6.5HP

biotriturador

Con cuchillas y contracuchillas

| | |
|----------------------|----------------------|
| Motor | Loncin 6,5 hp |
| Vel. Giro | 2.400 r.p.m |
| Producción | 3 m ³ / h |
| Ø Trituración Máxima | 100 mm |
| Embalaje | 870 x 555 x 850 mm |
| Peso | 100 kg |



| REFERENCIA | DESCRIPCIÓN |
|----------------|----------------------------------|
| BIOT6.5-2 | ROTOR |
| BIOT6.5-21 | INTERRUPTOR PARADA DE EMERGENCIA |
| BIOT6.5-26 | CUCHILLA INFERIOR |
| BIOT6.5-2EX | ROTOR ESTRIADO |
| BIOT6.5-3 | CUCHILLA |
| BIOT6.5-5 | RUEDA |
| BIOT6.5-6 | POLEA |
| BIOT6.5-7 | CORREA |
| BIOT6.5-8 | PROTECTOR CORREA |
| BIOT6.5-9 | EMBRAGUE |
| BIOT6.5-TC | TORNILLO CUCHILLAS |
| 193490011-0001 | ARRANQUE COMPLETO |
| 170020406-0001 | CARBURADOR |
| 270920162-0001 | BOBINA |
| SG30019 | FILTRO AIRE |

Descripción y usos: biotrituradora ideal para deshacerse de rastrojos, resto de poda, etc.... De motor de 6,5 HP, esta máquina tiene una capacidad de corte de 100 mm y una velocidad de cuchillas de 2.400 prm.



SG BIOT15HPAE PRO

biotriturador

Con 3 cuchilas y 10 martillos

Arranque eléctrico

Alimentación hidráulica

| | |
|---------------|---------------------|
| Motor | Loncin 15 hp |
| Vel.giro | 2000 rpm |
| Ø Trituración | 120 mm |
| Embalaje | 800 x 740 x 1230 mm |
| Peso | 330 kg |



| REFERENCIA | DESCRIPCIÓN |
|----------------|-------------------------------|
| DR-GS15SF-13 | EMBRAGUE DR-GS15SF |
| DR-GS15SF-52 | INTERRUPTOR |
| DR-GS15SF-53 | INTERRUPTOR |
| DR-GS15SF-59 | CUCHILLA |
| DR-GS15SF-62 | CORREA A500LI |
| DR-GS15SF-65 | INTERRUPTOR PARADA EMERGENCIA |
| DR-GS15SF-69 | BOMBA |
| DR-GS15SF-7 | CORREA |
| 193500017-0002 | ARRANQUE |
| 170021121-0001 | CARBURADOR |
| 270920182-0001 | BOBINA |
| SG30051 | FILTRO DE AIRE |

Descripción y usos: Biotrituradora de alimentación manual. Tritura grandes cantidades de hojas, ramas de palmera e incluso troncos.



SG PRO BIOT15HPAE

biotriturador

| | | |
|-------------------------|--------------------|--|
| 2 cuchillas reversibles | Arranque eléctrico | |
|-------------------------|--------------------|--|

| | |
|------------------------|----------------------|
| Motor | Loncin 15 HP |
| Vel. Giro | 2.000 rpm |
| Producción | 5 m ³ /h |
| Ø Trituración | 150 mm |
| Ancho máximo de madera | 300 mm |
| Embalaje | 1130 x 760 x 1250 mm |
| Peso | 250 kg |



| REFERENCIA | DESCRIPCIÓN |
|----------------|----------------------------------|
| BIOT15-12 | ROTOR EJE RECTO |
| BIOT15-29 | CUCHILLA INFERIOR |
| BIOT15-3 | CUCHILLA |
| BIOT15-4 | RUEDA |
| BIOT15-44 | INTERRUPTOR |
| BIOT15-47 | PARADA DE EMERGENCIA |
| BIOT15-6 | EMBRAGUE |
| 193500017-0002 | ARRANQUE |
| 170021121-0001 | CARBURADOR |
| 270920182-0001 | BOBINA |
| SG30051 | FILTRO DE AIRE |
| BIOT15-24 | CORREA SG BIOT15 HP 17x1025Li |

Descripción y usos: Biotrituradora de alimentación manual con dos cuchillas reversibles y que permite triturar grandes cantidades de hojas, ramas y troncos de hasta 300 mm de ancho.



SG BIOT HD

biotriturador

2 cuchillas

Arranque eléctrico

| | |
|---------------------------|---------------------|
| Motor biotriturador | Loncin 15 hp |
| Motor tractor | Loncin 6,5 hp |
| Vel. Giro | 2000 rpm |
| Producción | 4 m ³ /h |
| Ø Trituración | 120 mm |
| Dimensiones tolva pequeña | 295 x 155 mm |
| Dimensiones tolva grande | 380 x 440 mm |
| Embalaje | 900 x 750 x 1230 |
| Peso | 309 kg |



| REFERENCIA | DESCRIPCIÓN |
|----------------|---------------------------|
| SGBIOTHD-43 | CUCHILLAS TRITURADOR |
| SGBIOTHD-44 | CORREAS TRITURADOR |
| SGBIOTHD-46 | INTERRUPTOR TRITURADOR |
| SGBIOTHD-27 | POLEA EMBRAGUE TRITURADOR |
| 193500017-0002 | ARRANQUE TRITURADOR |
| 170021121-0001 | CARBURADOR TRITURADOR |
| 270920182-0001 | BOBINA TRITURADOR |
| SG30051 | FILTRO DE AIRE TRITURADOR |
| 2080026 | CORREA B32 |
| 5030061 | ORUGAS |
| 5010768 | MANDO CONTROL SEGURIDAD |
| 5010570 | CABLE POLEA TENSORA |
| 5030108 | MANETA |
| 5010059 | CABLE ACELERADOR |
| 5010295 | PALANCA ACELERADOR |
| 5010077 | INTERRUPTOR ON/OFF |

| | |
|----------------|----------------------------|
| 193490011-0001 | ARRANQUE COMPLETO TRACCION |
| 170020406-0001 | CARBURADOR TRACCION |
| 270920162-0001 | BOBINA TRACCION |
| SG30019 | FILTRO AIRE TRACCION |

Descripción y usos: Incorpora orugas para transporte profesional por terrenos inestables. Tritura grandes cantidades de hojas, incluso troncos de 120 mm.



SG AS 7T

astilladora

| | | | |
|----------------------|--------------------------------|---|--------------------------|
| Ruedas de transporte | Posición de trabajo horizontal | Cuña fija para ejercer de tope al empujador | Cubierta para protección |
|----------------------|--------------------------------|---|--------------------------|

| | |
|-------------|----------------------|
| Motor | Eléctrico |
| Potencia | 2.100W - 2.800 r.p.m |
| Presión | 7 t |
| Largo corte | 520 mm |
| Ancho corte | 200 mm |
| Embalaje | 1.000 x 285 x 460 mm |
| Peso | 46 kg |



| REFERENCIA | DESCRIPCIÓN |
|---------------|---------------------|
| AS-7T52-1T011 | CILINDRO COMPLETO |
| AS-7T52-48 | TAPA RUEDA PLÁSTICO |
| AS-7T52-49 | RUEDA |
| AS-7T52-49A | TAPACUBOS |
| AS-7T52-69 | MOTOR |
| AS-7T52-69A | INTERRUPTOR |
| AS-7T52-69C | CAJA INTERRUPTOR |
| AS-7T52-69D | CONDENSADOR |
| AS-7T52-72 | TAPA MOTOR |

Descripción y usos: Astilladora de leña 7 toneladas en posición horizontal, permitirá abrir troncos de árboles de madera blanda, como puede ser el pino, maderas de árboles frutales, chopo, entre otros. Además, incorpora estructura para protección de seguridad. **NO INCLUYE ACEITE HIDRÁULICO. El aceite recomendado es el SG HV 46. Por homologación solo puede trabajar en horizontal.**



SG AS 12 TG

astilladora

| | | |
|----------------------|------------------------------|--|
| Ruedas de transporte | Posición de trabajo vertical | Cuña fija para ejercer de tope al empujador hidráulico |
|----------------------|------------------------------|--|

| | |
|-------------|----------------------|
| Motor | Gasolina |
| Potencia | 6,5 hp Loncin |
| Presión | 12 t |
| Largo corte | 520 mm |
| Ancho corte | 300 mm |
| Embalaje | 748 x 453 x 115,8 mm |
| Peso | 106 kg |



| REFERENCIA | DESCRIPCIÓN |
|----------------|--------------------------------|
| SGAS12TE-15 | PLATINA GUIA CUCHILLA |
| SGAS12TE16 | PLATINA SEPARADORA CUCHILLA |
| SGAS12TE-17 | CUCHILLA |
| SGAS12TE-20 | BOTELLA HIDRÁULICA |
| SGAS12TE-26 | TAPON DEPÓSITO ACEITE |
| SGAS12TE-30 | CASQUILLO GOMA |
| SGAS12TE-39 | RUEDA |
| SGAS12TE-40 | TAPON DRENAJE M16X1.5 |
| SGAS12TE-45 | FILTRO ACEITE |
| SGAS12TE-60 | VALVULA CONTROL |
| SGAS12TE-61 | VALVULA DE CONTROL SG AS 12 TE |
| SGAS12TG56 | BOMBA |
| 193490011-0001 | ARRANQUE COMPLETO |
| 170020406-0001 | CARBURADOR |
| 270920162-0001 | BOBINA |
| SG30019 | FILTRO AIRE |

Descripción y usos: Astilladora perfecta para trabajar en casa o directamente en el lugar de derrame de árboles. Gracias a su motor gasolina, podemos cargarla en un remolque para poder trabajar donde queramos. Además con su poder de corte de 12 toneladas, este divisor es capaz de partir cualquier madera que cumpla y permita el ancho y largo de corte de la máquina. Por homologación SOLO puede trabajar en posición vertical.

NO INCLUYE ACEITE HIDRÁULICO. El aceite recomendado es el SG HV 46.



SG AS 12 TE

astilladora

| | | |
|----------------------|------------------------------|--|
| Ruedas de transporte | Posición de trabajo vertical | Cuña fija para ejercer de tope al empujador hidráulico |
|----------------------|------------------------------|--|

| | |
|-------------|---------------------|
| Motor | Eléctrico |
| Potencia | 3.000W- 230 V-50 Hz |
| Presión | 12 t |
| Largo corte | 520 mm |
| Ancho corte | 300 mm |
| Embalaje | 748 x 450 x 1128 |
| Peso | 106 kg |



| REFERENCIA | DESCRIPCIÓN |
|-------------|--------------------------------|
| SGAS12TE-12 | CHAPA METAL BLOQUEO |
| SGAS12TE-15 | PLATINA GUIA CUCHILLA |
| SGAS12TE16 | PLATINA SEPARADORA CUCHILLA |
| SGAS12TE-17 | CUCHILLA |
| SGAS12TE-20 | BOTELLA HIDRÁULICA |
| SGAS12TE-26 | TAPON DEPÓSITO ACEITE |
| SGAS12TE-30 | CASQUILLO GOMA |
| SGAS12TE-39 | RUEDA |
| SGAS12TE-40 | TAPON DRENAJE M16X1.5 |
| SGAS12TE-45 | FILTRO ACEITE |
| SGAS12TE-49 | MOTOR ELECTRICO 230V/50HZ |
| SGAS12TE-55 | BOMBA SG AS 12 TE |
| SGAS12TE-60 | VALVULA CONTROL |
| SGAS12TE-61 | VALVULA DE CONTROL SG AS 12 TE |
| SGAS12TE-76 | INTERRUPTOR |

Descripción y usos: una velocidad de cuchilla. Gracias a su poder de corte de 12 toneladas, este divisor es capaz de partir cualquier madera que cumpla y permita el ancho y largo de corte de la máquina. Esta máquina tiene un marco robusto con un excelente acabado. Por homologación SOLO puede trabajar en posición vertical.

NO INCLUYE ACEITE HIDRÁULICO. El aceite recomendado es el SG HV 46.



*cumple normativa CE

SG AS 22T

astilladora

| | | | |
|----------------------|----------|--|---------------------------------------|
| Ruedas de transporte | Vertical | Cuña fija para ejercer de tope al empujador hidráulico | Empujador hidráulico en forma de cuña |
|----------------------|----------|--|---------------------------------------|

| | |
|-------------|--------------------------|
| Motor | Gasolina |
| Potencia | 6,5 hp Loncin |
| Presión | 22 t |
| Largo corte | 610 mm |
| Ancho corte | Ø 450 mm |
| Embalaje | 2.250 x 1.100 x 1.225 mm |
| Peso | 220 kg |



| REFERENCIA | DESCRIPCIÓN |
|----------------|---------------------------------|
| LSA22-03001 | PLATINA GUIA CUCHILLA SG AS 22T |
| LSCA22-07001 | VALVULA CONTROL SG AS 22T |
| LSE2201-SEAL | KIT REPARACION CILINDRO LSE2201 |
| LSE2203-04000 | CUCHILLA SG AS 22T |
| LSE2203-12000 | BOTELLA SG AS 22T |
| LSE2203-14000 | INTERRUPTOR CORTE ELECTRICO |
| LSE22-06001 | DISTRIBUIDOR LSE2201/LSE35 |
| 193490011-0001 | ARRANQUE COMPLETO |
| 170020406-0001 | CARBURADOR |
| 270920162-0001 | BOBINA |
| SG30019 | FILTRO AIRE |

Descripción y usos: Ha sido creada de acuerdo con los últimos estándares de calidad y seguridad. Astilladora profesional preparada para uso intensivo. Es ideal para cortar madera en el bosque o en casa. La cuchilla de corte está hecha de acero especial parcialmente endurecido para una larga vida. **NO INCLUYE ACEITE HIDRÁULICO. REMOLQUE NO VÁLIDO PARA CIRCULAR EN CARRETERA.**

ACEITE HIDRÁULICO



SG HV46 5L

aceite hidráulico para astilladoras

Aceite hidráulico anti-desgaste de muy altas prestaciones para todo tipo de sistemas hidráulicos que trabajan en condiciones elevadas de presión y temperatura



SG HV46 20L

aceite hidráulico para astilladoras

Aceite hidráulico anti-desgaste de muy altas prestaciones para todo tipo de sistemas hidráulicos que trabajan en condiciones elevadas de presión y temperatura



DESBROZADORAS
VAREADORES
CORTACÉSPEDES
CORTASETOS
SOPLADORES
PULVERIZACIÓN
MOTOBOMBAS
BOMBAS
HIDROLIMPIADORAS

JARDÍN





SG-DESBROZADORA 4 T 43

desbrozadora

| | | |
|---|---------------------|------------------------|
| Silenciosa y con sistema de arranque fácil. | Motor de 4 tiempos. | Equipamiento incluido. |
|---|---------------------|------------------------|

| | |
|-----------------|---------------------|
| Cilindrada | 42,5 cc |
| Potencia | 1,56 KW / 7500 RPM |
| Motor | 4 tiempos |
| Modelo de motor | TT-142F/ TT-S50 |
| Dep. Gasolina | 550 ml |
| ØBarra | 28 mm |
| Embalaje | 1850 x 280 x 250 mm |
| Peso | 9,5 kg |

EQUIPAMIENTO INCLUIDO



| REFERENCIA | DESCRIPCIÓN |
|----------------|----------------------------------|
| TT4352BN40-50 | CAMPANA EMBRAGUE COMPLETA |
| TT4352N28-31 | PROTECTOR |
| TT4352N32 | SOPORTE |
| TT4352NMANDOAC | MANDO ACELERADOR |
| TT4352NP | POMO MANILLAR |
| TT508-1/21N | CABEZAL D.28 9 ESTRIAS |
| TT508-1/21N-BL | BLOQUEO CABEZAL TT508-1/21N |
| TT508-1/21N-PR | PROTECTOR ESTABILIZ |
| TT508-49 | TUBO TRANSMISION BARRA |
| TT508-31 | EJE TRANSMISION |
| TT-BC508-1/32 | SILENTBLOCK CON CASQUILLO SG 508 |
| TTS50-A | ARRANQUE COMPLETO |
| TTS50-B | POLEA DE ARRANQUE |
| TTS50-47 | CARBURADOR |
| TTS50-53 | FILTRO AIRE |
| TTS50-76 | BOBINA |
| TTS50-90 | EMBRAGUE |
| TTS50-E | DEPÓSITO COMPLETO |
| TTS50-F | TAPON DEPÓSITO |

Descripción y usos: Se trata de una cómoda y silenciosa desbrozadora con arranque fácil y motor de 4 tiempos, con un régimen de vueltas inferior a los de 2 tiempos. NO necesita mezcla de aceite en gasolina. Incorpora además un equipamiento de serie con arnés, cabezal y disco de 3 puntas.



SG 508

desbrozadora

Silentblocks autolubricados que reducen las vibraciones procedentes del motor y del eje de transmisión

Anclaje del arnés multipunto. Sistema de arranque fácil.

Sistema de ajuste rápido con pomo, sin necesidad de empleo de herramientas para su instalación.

Tubo de aluminio de 2 mm. de espesor y protector de disco. Protector de depósito para colgar en pared.

| | |
|---------------|----------------------|
| Motor | Sport Garden |
| Cilindrada | 50,8 cc |
| Potencia | 2,45 hp |
| Dep. Gasolina | 800 ml |
| ØBarra | 28 mm |
| Embalaje | 1.850 x 285 x 280 mm |
| Peso | 10,8 kg |

EQUIPAMIENTO INCLUIDO



| REFERENCIA | DESCRIPCIÓN |
|----------------|-------------------------------------|
| TT508-1/21N | CABEZAL D.28 9 ESTRIAS |
| TT508-1/21N-BL | BLOQUEO CABEZAL TT508-1/21N |
| TT508-1/21N-PR | PROTECTOR ESTABILIZADOR TT508-1/21N |
| TT508-22/29 | PROTECTOR CABEZAL SG 508 |
| TT508-31 | EJE TRANSMISION SG 508 |
| TT508-36 | MANDO ACELERADOR SG 508 |
| TT508-46 | MUELLE CARENADO BARRA SG 508 |
| TT508-48 | SILENT BLOCK CARENADO BARRA SG 508 |
| TT508-49 | TUBO TRANSMISION BARRA SG 508 |
| TT508-55/62 | CAMPANA COMPLETA BARRA SG 508 |
| TT508-H10 | BOBINA SG 508 |
| TT508-H11 | CILINDRO SG 508 |
| TT508-H18 | CEBADOR SG 508 |
| TT508-H26 | JUNTA CILINDRO SG 508 |
| TT508-H27/31 | KIT PISTÓN SG 508 |
| TT508-H3/6 | EMBRAGUE SG 508 |
| TT508-H35 | CARBURADOR SG 508 |
| TT508-H51 | POLEA DE ARRANQUE SG 508 |
| TT508-H53 | ARRANCADOR COMPLETO SG 508 |
| TT508-H64 | DEPÓSITO COMPLETO SG 508 |
| TT508-H65 | TAPÓN DEPÓSITO SG 508 |
| TT508-H67/71 | TUBOS Y FILTRO DE GASOLINA SG 508 |
| TT508-MANILLAR | MANILLAR SG 508 |

Descripción y usos: La desbrozadora a gasolina SG 508 es perfecta para aquellos usuarios exigentes y amantes de la jardinería. Anclaje de arnés multipunto para mayor comodidad de trabajo. Protector de depósito para colgar en pared y ahorrar espacio en casa, así como arranque fácil para evitar quebraderos de cabeza. Uso semiprofesional.



SPORTGARDEN 62

desbrozadora

| | | | |
|--|--|---|--|
| Silentblocks autolubricados que reducen las vibraciones procedentes del motor y del eje de transmisión | Anclaje del arnés multipunto. Sistema de arranque fácil. | Sistema de ajuste rápido con pomo, sin necesidad de empleo de herramientas para su instalación. | Tubo de aluminio de 2 mm. de espesor y protector de disco. Protector de depósito para colgar en pared. |
|--|--|---|--|

| | |
|---------------|---------------------|
| Motor | Sport Garden |
| Cilindrada | 62 cc |
| Potencia | 3,5 hp |
| Dep. Gasolina | 900 ml |
| ØBarra | 28 mm |
| Embalaje | 1665 x 105 x 100 mm |
| Peso | 10,8 kg |

EQUIPAMIENTO INCLUIDO



| REFERENCIA | DESCRIPCIÓN |
|----------------|-------------------------------------|
| TT508-1/21N | CABEZAL D.28 9 ESTRIAS |
| TT508-1/21N-BL | BLOQUEO CABEZAL TT508-1/21N |
| TT508-1/21N-PR | PROTECTOR ESTABILIZADOR TT508-1/21N |
| TT508-22/29 | PROTECTOR CABEZAL |
| TT508-31 | EJE TRANSMISION |
| TT508-36 | MANDO ACELERADOR |
| TT508-46 | MUELLE CARENADO BARRA |
| TT508-48 | SILENT BLOCK CARENADO BARRA |
| TT508-49 | TUBO TRANSMISION BARRA |
| TT508-55/62 | CAMPANA COMPLETA BARRA |
| BC620-A8 | EMBRAGUE |
| BC620-A17 | BOBINA |
| BC620-A20 | ESCAPE |
| BC620-A29 | CEBADOR |
| BC620-A32 | JUNTA CILINDRO |
| BC620-A33 | AROS |
| BC620-A34 | PISTON |
| BC620-A35 | BULON |

| | |
|-----------|-------------------|
| BC620-A36 | CLIPS PISTON |
| BC620-A37 | RODAMIENTO PISTON |
| BC620-A44 | FILTRO AIRE |
| BC620-A49 | CARBURADOR |
| BC620-AA | Depósito |
| BC620-A70 | CAMPANA ARRANQUE |
| BC620-AB | ARRANQUE COMPLETO |

Descripción y usos: La desbrozadora a gasolina SPORTGARDEN 62 es perfecta para aquellos usuarios exigentes y amantes de la jardinería. Anclaje de arnés multipunto para mayor comodidad de trabajo. Protector de depósito para colgar en pared y ahorrar espacio en casa, así como arranque fácil para evitar quebraderos de cabeza. Uso semiprofesional.

DISEÑO EXCLUSIVO Y RENOVADO



SG-DMULTI 330

multifunción

| | |
|-------------------|--------------|
| Motor | Sport Garden |
| Cilindrada | 32,6 cc |
| Potencia | 1,22 hp |
| Depósito gasolina | 1.100 ml |
| Ø barra | 26 mm |

cortasetos

| | |
|-------------------|---------|
| Longitud de tubo | 780 mm |
| Longitud cuchilla | 640 mm |
| Longitud total | 1420 mm |
| Peso | 2,1 kg |

desbrozadora

| | |
|------------------|--------|
| Longitud de tubo | 780 mm |
| RPM | 7500 |
| N de estrias | 9 |
| Diámetro | 8 mm |

motosierra

| | |
|----------------|---------|
| Cadena | 3/8" |
| Sable | 12" |
| Longitud tubo | 780 mm |
| Longitud | 40 mm |
| Longitud corte | 1115 mm |
| Peso | 2,1 kg |

total

| | |
|----------|---------------------|
| Embalaje | 1050 x 280 x 380 mm |
| Peso | 12,8 kg |



| REFERENCIA | DESCRIPCIÓN |
|----------------|-------------------------------|
| TT-M2600-1-N6 | EMBRAGUE |
| TT-M2600-1-N11 | BOBINA |
| TT-M2600-1-N29 | JUNTA CILINDRO |
| TT-M2600-1-N30 | AROS |
| TT-M2600-1-N31 | PISTON |
| TT-M2600-1-N32 | BULON |
| TT-M2600-1-N33 | CLIPS |
| TT-M2600-1-N34 | RODAMIENTO PISTON |
| TT-M2600-1-N38 | CARBURADOR |
| TT-M2600-1-N41 | FILTRO DE AIRE |
| TT-M2600-1-N55 | CAMPANA ARRANQUE |
| TT-M2600-1-N57 | ARRANQUE COMPLETO |
| TT-M2600-1-N68 | DEPÓSITO COMPLETO |
| TT-M2600-1-N69 | TAPON GASOLINA |
| TT-M2600-1-I10 | CABEZAL COMPLETO |
| TT-M2600-1-I30 | PROTECTOR CABEZAL COMPLETO |
| TT-M2600-1-J50 | CUCHILLAS |
| TT-M2600-1-J | ACCESORIO CORTASETOS COMPLETO |
| TT-M2600-1-G | GRUPO PODADOR COMPLETO |
| TT-M2600-1-G7 | SABLE GRUPO PODADOR |
| TT-M2600-1-G8 | CADENA GRUPO PODADOR |

Descripción y usos: Con esta desbrozadora multifunción tendremos a nuestro alcance poder desempeñar cualquier tipo de trabajo en nuestra finca o jardín. Gracias a su enganche central metálico reforzado, podemos intercambiar las distintas herramientas de una forma muy cómoda.



DGREEN 52

desbrozadora

| | |
|----------------|------------------------|
| Motor | 2T (Enfriado por aire) |
| Cilindrada | 52 cc |
| Potencia | 1,9 hp |
| Dep. Gasolina | 1,2 L |
| Ø Barra | 28 mm |
| Ø Hilo cabezal | 2,4 mm |
| Ø Disco corte | 255 |
| Embalaje motor | 625 x 370 x 230 mm |
| Embalaje barra | 630 x 190 x 285 mm |
| Peso | 8 kg |

EQUIPAMIENTO INCLUIDO



| REFERENCIA | DESCRIPCIÓN |
|-------------------|-------------------------------------|
| EBC4352BHN1 | CABEZAL COMPLETO GBC |
| EBC4352BHN21 | PROTECTOR ESTABILIZADOR |
| EBC4352BHN22 | TUERCA CABEZAL GBC |
| EBC4352BHN26-27 | SILENTBLOCK CON CASQUILLO BARRA GBC |
| EBC4352BHN28 | VARILLA GBC |
| EBC4352BHN29 | BARRA D.28 GBC |
| EBC4352BHN35 | CAMPANA COMPLETA GBC |
| EBC4352BHN5052Y55 | ABRAZADERA MANILLAR B.28 M.19 |
| EBC4352BHN58 | MANDO ACELERADOR GBC T.19 800MM. |
| CG520-59 | MANILLAR |
| MMAXIMA52 | MOTOR |
| CG520-03 | KIT CILINDRO 52CC |
| GBC4352N38 | EMBRAGUE |
| GBC4352N61 | ESCAPE |
| GBC4352N68 | CARBURADOR |
| GBC4352N83 | ARRANQUE COMPLETO |
| GBC4352N99 | TAPON DEPOSITO |
| GBC4352N100 | DEPOSITO COMBUSTIBLE |

NUEVO

SG-TJ45E

desbrozadora

 Powered by
Kawasaki

| | |
|---------------|---------------------|
| Motor | Kawasaki Tj 45 |
| Cilindrada | 45,4 cc |
| Potencia | 2,2 hp |
| Dep. Gasolina | 0,9 L |
| ØBarra | 28 mm |
| Embalaje | 1820 x 290 x 210 mm |
| Peso | 8,5 kg |

EQUIPAMIENTO INCLUIDO



| REFERENCIA | DESCRIPCIÓN |
|------------|---------------------------------|
| SGTJ-1 | CABEZAL COMPLETO |
| SGTJ-13 | TUERCA CABEZAL |
| SGTJ-21 | ARANDELA SUPERIOR CABEZAL |
| SGTJ-22 | ARANDELA INFERIOR CABEZAL |
| SGTJ-23 | PROTECTOR ESTABILIZADOR CABEZAL |
| SGTJ-30 | SOPORTE ARNES |
| SGTJ-24 | BARRA VARILLA Y SILENTBLOCKS |
| SGTJ-46 | CAMPANA EMBRAGUE COMPLETA |
| SGTJ-47 | PROTECTOR CABEZAL |
| SGTJ-72 | MANDO ACELERADOR |
| SGTJ-74 | PALOMETA |
| SGTJ-74/81 | SOPORTE MANILLAR |
| SGTJ-82 | MANILLAR |
| SGTJ-83 | POMO MANILLAR |
| 490880710 | ARRANQUE COMPLETO |
| 211710709 | BOBINA ENCENDIDO |
| 150040708 | CARBURADOR |
| 130812220 | EMBRAGUE |
| 490432067 | CEBADOR |
| 110130711 | FILTRO DE AIRE |
| 999966089 | TAPON DEPOSITO |

**NUEVO****SG-TJ53E**

desbrozadora

Powered by
Kawasaki

| | |
|---------------|---------------------|
| Motor | Kawasaki Tj 53 |
| Cilindrada | 53,2 cc |
| Potencia | 2,7 hp |
| Dep. Gasolina | 1,1 L |
| ØBarra | 28 mm |
| Embalaje | 1820 x 290 x 210 mm |
| Peso | 9,5 kg |

EQUIPAMIENTO INCLUIDO

| REFERENCIA | DESCRIPCIÓN |
|------------|---------------------------------|
| SGTJ-1 | CABEZAL COMPLETO |
| SGTJ-13 | TUERCA CABEZAL |
| SGTJ-21 | ARANDELA SUPERIOR CABEZAL |
| SGTJ-22 | ARANDELA INFERIOR CABEZAL |
| SGTJ-23 | PROTECTOR ESTABILIZADOR CABEZAL |
| SGTJ-30 | SOPORTE ARNES |
| SGTJ-24 | BARRA VARILLA Y SILENTBLOCKS |
| SGTJ-46 | CAMPANA EMBRAGUE COMPLETA |
| SGTJ-47 | PROTECTOR CABEZAL |
| SGTJ-72 | MANDO ACELERADOR |
| SGTJ-74 | PALOMETA |
| SGTJ-74/81 | SOPORTE MANILLAR |
| SGTJ-82 | MANILLAR |
| SGTJ-83 | POMO MANILLAR |
| 490880711 | ARRANQUE COMPLETO |
| 211712292 | BOBINA ENCENDIDO |
| 150042100 | CARBURADOR |
| 130812224 | EMBRAGUE |
| 490432067 | CEBADOR |
| 110132242 | FILTRO DE AIRE |
| 999966089 | TAPON DEPOSITO |



SPORTGARDEN TJ45 N

desbrozadora

USO PROFESIONAL



Silentblocks autolubricados que reducen las vibraciones procedentes del motor y del eje de transmisión.

Anclaje del arnés multipunto

Sistema de ajuste rápido con pomo, sin necesidad de empleo de herramientas para su instalación.

Tubo de aluminio de 2 mm. de espesor y protector de disco

| | |
|------------|----------------------|
| Motor | Kawasaki Tj 45E |
| Cilindrada | 45,4 cc |
| Potencia | 2,2 hp |
| ØBarra | 28 mm |
| Embalaje | 1.820 x 260 x 295 mm |
| Peso | 8 kg |

EQUIPAMIENTO INCLUIDO



| REFERENCIA | DESCRIPCIÓN |
|----------------|-------------------------------------|
| TT508-1/21N | CABEZAL D.28 9 ESTRIAS |
| TT508-1/21N-BL | BLOQUEO CABEZAL TT508-1/21N |
| TT508-1/21N-PR | PROTECTOR ESTABILIZADOR TT508-1/21N |
| TT508-22/29 | PROTECTOR CABEZAL |
| TT508-31 | EJE TRANSMISION |
| TT508-36 | MANDO ACELERADOR |
| TT508-46 | MUELLE CARENADO BARRA |
| TT508-48 | SILENT BLOCK CARENADO BARRA |
| TT508-49 | TUBO TRANSMISION BARRA |
| TT508-55/62 | CAMPANA COMPLETA BARRA |
| 490880710 | ARRANQUE COMPLETO TJ045E-KS51 |
| 211710709 | BOBINA ENCENDIDO TJ045E-KS51 |
| 150040708 | CARBURADOR TJ045E-KS51 |
| 130812220 | EMBRAGUE TH043D/TJ045E |
| 490432067 | CEBADOR TH023D/YJ053E/TJ045E |
| 110130711 | FILTRO DE AIRE TJ045E-KS51 |
| 999966089 | TAPON DEPÓSITO TJ045E/TJ053E |

Descripción y usos: es una máquina profesional que engloba potencia, eficiencia, fiabilidad y al mismo tiempo resulta extremadamente versátil. Ideal para situaciones difíciles como hierba alta y maleza. El motor kawasaki permite 30% consumo más bajo, así como arranque inmediato y funcional.



SPORTGARDEN TJ53 N



desbrozadora

USO PROFESIONAL

| | | | |
|---|------------------------------|---|---|
| Silentblocks autolubricados que reducen las vibraciones procedentes del motor y del eje de transmisión. | Anclaje del arnés multipunto | Sistema de ajuste rápido con pomo, sin necesidad de empleo de herramientas para su instalación. | Tubo de aluminio de 2 mm. de espesor y protector de disco |
|---|------------------------------|---|---|

| | |
|------------|----------------------|
| Motor | Kawasaki Tj 53 |
| Cilindrada | 53 cc |
| Potencia | 2,7 hp |
| ØBarra | 28 mm |
| Embalaje | 1.820 x 260 x 295 mm |
| Peso | 8 kg |

EQUIPAMIENTO INCLUIDO



| REFERENCIA | DESCRIPCIÓN |
|----------------|-------------------------------------|
| TT508-1/21N | CABEZAL D.28 9 ESTRIAS |
| TT508-1/21N-BL | BLOQUEO CABEZAL TT508-1/21N |
| TT508-1/21N-PR | PROTECTOR ESTABILIZADOR TT508-1/21N |
| TT508-22/29 | PROTECTOR CABEZAL |
| TT508-31 | EJE TRANSMISION |
| TT508-36 | MANDO ACELERADOR |
| TT508-46 | MUELLE CARENADO BARRA |
| TT508-48 | SILENT BLOCK CARENADO BARRA |
| TT508-49 | TUBO TRANSMISION BARRA |
| TT508-55/62 | CAMPANA COMPLETA BARRA |
| 490880711 | ARRANQUE COMPLETO TJ053E-AS50 |
| 211712292 | BOBINA ENCENDIDO TJ053E-AS50 |
| 150042100 | CARBURADOR TJ053E-AS50 |
| 130812224 | EMBRAGUE TJ053E-AS50 (130810605) |
| 490432067 | CEBADOR TH023D/YJ053E/TJ045E |
| 110132242 | FILTRO DE AIRE TJ053E-AS50 |
| 999966089 | TAPON DEPÓSITO TJ045E/TJ053E |

Descripción y usos: Con la TJ53 obtendrás un corte de hierba profesional incluso en los bordes y esquinas a los que son difíciles acceder. Máquina profesional que engloba potencia, eficiencia, fiabilidad y al mismo tiempo resulta extremadamente versátil. Ideal para situaciones difíciles como hierba alta. Calidad, durabilidad y profesionalidad. El motor kawasaki permite 30% consumo más bajo, así como arranque inmediato y funcional.



SG VAREADOR PODADORA **PEINE DE DOBLE BIELA**

vareador podador

Interruptor de parada de motor que permite parar el motor desde la empuñadura.

Enganche rápido que permite cambiar de accesorio de manera sencilla.

Arranque fácil

| | |
|-------------------|--------------|
| Motor | Sport Garden |
| Cilindrada | 32,6 cc |
| Potencia | 1,22 hp |
| Depósito gasolina | 1.100 ml |
| Ø Barra | 26 mm |
| Peso | 12 Kg |



| REFERENCIA | DESCRIPCIÓN |
|----------------|-------------------------------|
| 2320061522 | PLATAFORMA PORTA PUNTERAS "Z" |
| 4GS-50.1.3 | VARETAS SG VAREADOR |
| 4GS-50DB | CABEZAL VAREADOR DOBLE BIELA |
| 2320061522 | PLATAFORMA PORTA PUNTERAS "Z" |
| SGVKDB | KIT DOBLE BIELA |
| 1E36F-2C.4.1 | EMBRAGUE |
| 1E34F.1-1 | FILTRO AIRE |
| 1E36FE.9 | ARRANQUE COMPLETO |
| 1E36FE.7 | CAMPANA DE ARRANQUE |
| 1E34F-2E.1A | CARBURADOR |
| 1E36F-2E.2.1.2 | BOBINA COMPLETA |

Descripción y usos: SG vareadora podadora, con Kit Multifunción, lo que permite tener 2 herramientas en una sola máquina. Para trabajos de poda en altura, sin asumir el riesgo de escalera, y trabajo cómodo con el peso del motor abajo.



SG VAREADOR

PEINE DE DOBLE BIELA

vareador

| | | |
|--|--|----------------|
| Interruptor de parada de motor que permite parar el motor desde la empuñadura. | Enganche rápido que permite cambiar de accesorio de manera sencilla. | Arranque fácil |
|--|--|----------------|

| | |
|----------------|----------------------|
| Motor | Sport Garden |
| Cilindrada | 26 cc |
| Potencia | 1,6 hp |
| Dep. Gasolina | 1.200 ml |
| ØBarra | 28 mm |
| Embalaje barra | 1.650 x 105 x 100 mm |
| Embalaje motor | 660 x 200 x 285 mm |
| Peso | 7,3 kg |

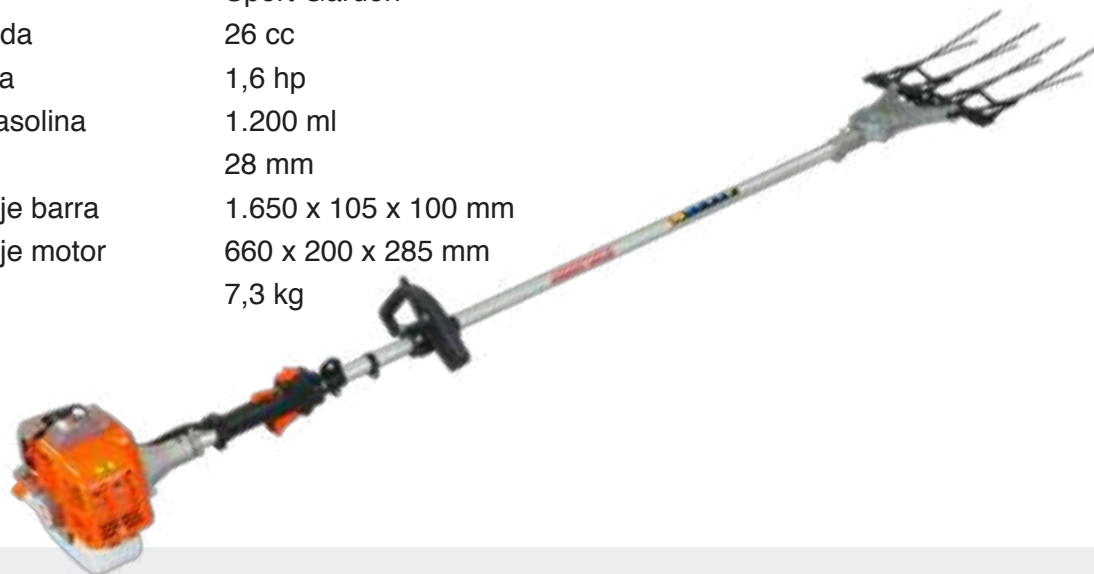

| REFERENCIA | DESCRIPCIÓN |
|-----------------|-------------------------------|
| 2320061522 | PLATAFORMA PORTA PUNTERAS "Z" |
| 4GS-50.1.3 | VARETAS SG VAREADOR |
| 4GS-50DB | CABEZAL VAREADOR DOBLE BIELA |
| SGVKDB | KIT DOBLE BIELA SG VAREADOR |
| 1E34F.10C-1 | EMBRAGUE |
| 1E34F.1-1 | FILTRO AIRE |
| 1E34F.11G | ARRANQUE COMPLETO |
| 1E34F.8 | CAMPANA DE ARRANQUE |
| 1E34F-2E.1A-GGP | CARBURADOR |
| 1E34F-2E.3.2 | BOBINA |

Descripción y usos: Vareador de olivas profesional con motor gasolina de 26 cc y 1,6 hp de potencia.



SG AHOYADOR 508

ahoyador

| | |
|-------------|--------------------|
| Cilindrada | 50,8 cc |
| Potencia | 1,70 Kw/ 7600 rpm |
| Profundidad | 80 cm/máx. |
| Embalaje | 830 x 570 x 280 mm |
| Peso | 20 kgs |

| REFERENCIA | DESCRIPCIÓN |
|------------------|----------------------|
| XT-GD508-2-2/4 | MANILLAR |
| XT-GD508-2-7/21 | GRUPO COMPLETO |
| XT-GD508-2-29/34 | INTERRUPTOR COMPLETO |
| XT-GD508-2-M5 | EMBRAGUE |
| XT-GD508-2-M10 | BOBINA |
| XT-GD508-2-M26 | JUNTA CILINDRO |
| XT-GD508-2-M27 | AROS |
| XT-GD508-2-M28 | PISTON |
| XT-GD508-2-M29 | BULON |
| XT-GD508-2-M30 | CLIPS PISTON |
| XT-GD508-2-M35 | CARBURADOR |
| XT-GD508-2-M53 | ARRANQUE COMPLETO |
| XT-GD508-2-M65 | DEPOSITO COMPLETO |
| XT-GD508-2-M66 | TAPON GASOLINA |



BROCAS DE 100,150 Y 200 mm

Descripción y usos: ideal para hacer agujeros para plantación de arboles, arbustos o frutales. Fácil manejo.



SG AHOYADOR 520

ahoyador

| | | |
|------------------------------------|--|--|
| Incluye protector antivibraciones. | Doble manillar para mejorar la sujeción de uno o 2 trabajadores. | Brocas helicoidales dobles para mayor eficacia en perforación. |
|------------------------------------|--|--|

| | |
|---------------|--------------------|
| Motor | Sport Garden |
| Cilindrada | 51,7 cc |
| Potencia | 2,1 hp |
| Dep. gasolina | 1,2 L |
| Profundidad | 80 cm/máx. |
| Embalaje | 830 x 570 x 280 mm |
| Peso | 17 kg |

BROCAS DE 100,150 Y 200 mm

Descripción y usos: la máquina perfecta que dispone de una varilla resistente en forma de tornillo y un manillar para un correcto agarre que permite hacer hoyos. Muy útil para campos de cultivo, para agilizar las jornadas de trabajo y facilitar la perforación en terrenos difíciles.





SG 3610 AU

cortacésped

| | |
|------------------------|---|
| Motor | Loncin |
| Tipo de arranque | Manual |
| Potencia neta | 4,1 kw/ 3600 rpm |
| Cilindrada | 196 cc / 6,5 HP |
| Cap.tanque combustible | 1.0 L |
| Cap.aceite | 0,6 L |
| Tipo de accionamiento | Autopropulsado con palanca de freno y cable de acelerador |
| Ancho de corte (mm) | 610 mm |
| Altura de corte (mm) | 25/40/55/75 |
| Velocidad | 0.4 -1 m/s |
| Dimensiones | 1020 x 700 x 535 mm |
| Peso | 135 kg |



| REFERENCIA | DESCRIPCIÓN |
|----------------|-----------------------------------|
| SG3610AU-147 | RUEDA |
| SG3610AU-183 | PALANCA ACELERADOR |
| SG3610AU-21 | CORREA V |
| SG3610AU-37 | CABLE EMBRAGUE |
| SG3610AU-41 | SOPORTE CUCHILLA |
| SG3610AU-42 | CUCHILLA |
| SG3610AU-64 | CORREA DENTADA PRINCIPAL 650-5M15 |
| SG3610AU-7 | RUEDA DELANTERA |
| 170020433-0001 | CARBURADOR LC1P70 |

Descripción y usos: SG 3610 AU es una máquina robusta diseñada para hierba alta y limpieza de matorrales pequeños. Fiabilidad, maniobrabilidad y la ergonomía. Alta capacidad de siega / limpieza y autopropulsado con grandes ruedas traseras para una buena tracción. Cuenta con una rueda delantera giratoria para un manejo óptimo.



SG CH 460

cortacésped manual helicoidal

| | |
|-----------------|--------------------|
| Ancho de corte | 460 mm |
| Altura de corte | 39 - 69 mm |
| Rueda | 10" PP+ PVC |
| Capacidad | 25 L |
| Engranaje | Plástico |
| Peso | 13,9 kg |
| Embalaje | 625 x 440 x 260 mm |



EQUIPAMIENTO INCLUIDO



Descripción y usos: SG CH 460 es el cortacésped perfecto para terrenos pequeños donde hay árboles y zonas muy estrechas. Recomendado para superficies de hasta 150 m².



GT 42

cortacésped

| | |
|-------------------------|------------------------------|
| Motor | Loncin |
| Cilindrada | 123 cc |
| Sistema accionamiento | Empuje manual |
| Ancho de corte | 420 mm |
| Altura de corte | 25-75 mm con 6 posiciones |
| Depósito combustible | 1 L |
| Volumen de aceite | 0,6 L |
| Material cubierta | Acero |
| Tamaño rueda delantera | 6 pulgadas |
| Tamaño de rueda trasera | 7 pulgadas |
| Función de descargaw | Recogida y mulching. |
| Capacidad recolector | 45 L |
| Embalaje | 720 x 520 x 440 mm |



| REFERENCIA | DESCRIPCIÓN |
|----------------|-------------------------|
| G639XXNN000 | CABLE |
| G34AWY00000 | SOPORTE CUCHILLA |
| G623N0000000 | TAPA CORREA |
| G55100000000 | CUCHILLA 20" |
| B1001B00032 | TORNILLO CUCHILLA |
| G54N1000000 | RUEDA 11" (TRASERA) |
| G34H1000000 | RUEDA 8" (DELANTERA) |
| BA001B00000 | CORREA |
| G54AL000000 | PIÑÓN IZQ |
| G54AM000000 | PIÑÓN DCH |
| G34GT000000 | TRACCION |
| G21K1000000 | SACO CESTO |
| 193490527-0003 | ARRANQUE COMPLETO |

| | |
|----------------|------------------------------|
| 170022364-0001 | CARBURADOR |
| 270920529-0001 | BOBINA |
| 270020277-0002 | PLATO MAGNETICO |
| 180130178-0001 | FILTRO DE AIRE COM- PLETO |
| 170870156-0001 | TAPON GASOLINA |

Descripción y usos: Se trata de un cortacésped de empuje manual y con un ancho de corte de 420 cm. Cuenta con ajuste de la altura de corte con 6 posiciones. Perfecto para jardines de tamaño medio y pensado para tareas complejas de mantenimiento. Incorpora un recolector de hierba de 45 litros.



SG CORTACESPED 48 SLT

cortacésped

| | |
|-------------------------|--|
| Motor | Loncin |
| Cilindrada | 196 cc |
| Sistema accionamiento | Autopropulsado |
| Ancho de corte | 480 mm |
| Altura de corte | 25-75 mm con 6 posiciones |
| Depósito combustible | 1 L |
| Volumen aceite | 0,6 L |
| Material cubierta | Acero |
| Tamaño rueda delantera | 7 pulgadas |
| Tamaño de rueda trasera | 10 pulgadas |
| Función 3 en 1 | Recogida, mulching, y salida lateral. |
| Material recolector | Plástico |
| Capacidad recolector | 65 L |
| Embalaje | 780 x 570 x 485 mm |



| REFERENCIA | DESCRIPCIÓN |
|----------------|-------------------------|
| G34AWY00000 | ADAPTADOR CUCHILLA |
| G423N000000 | CUBIERTA CORREA |
| G4510000000 | CUCHILLA 19" |
| BA00GB00000 | CORREA |
| G34GT000000 | TRACCIÓN |
| G34L1000000 | RUEDA TRASERA 10" |
| G639XXN0000 | CABLE FRENO |
| G339XYC0000 | CABLE EMBRAGUE |
| B0014W00000 | RODAMIENTO RUEDA |
| 193490527-0003 | ARRANQUE COMPLETO |
| 170022364-0001 | CARBURADOR |
| 270920529-0001 | BOBINA |
| 270020277-0002 | PLATO MAGNETICO |
| 180130178-0001 | FILTRO DE AIRE COMPLETO |
| 170870156-0001 | TAPON GASOLINA |

Descripción y usos: Las prestaciones de este cortacésped de gasolina son excelentes. Su potencia y su autonomía hacen de esta herramienta una máquina ideal para grandes superficies de terreno. Hablamos de un dispositivo práctico, versátil y fácil de usar. Es un cortacésped potente, versátil y cómodo que hará de los trabajos en tu jardín un disfrute constante y te proporcionará los mejores resultados.



SG CORTACESPED 51 SLT

cortacésped

| | |
|---------------------------------|--|
| Motor | Loncin |
| Cilindrada | 196 cc |
| Sistema accionamiento | Autopropulsado |
| Manillar | Fijo |
| Ancho de corte | 508 mm |
| Altura de corte | 25-75 mm con 6 posiciones |
| Depósito combustible | 1 L |
| Volumen de aceite | 0,6 L |
| Material cubierta | Acero |
| Tamaño rueda delantera | 8 pulgadas |
| Tamaño de rueda trasera | 11 pulgadas |
| Característica única de bloqueo | En rueda trasera |
| Función 3 en 1 | Recogida, mulching, y salida lateral. |
| Capacidad recolector | 65 L |
| Embalaje | 925 x 570 x 485 mm |



| REFERENCIA | DESCRIPCIÓN |
|----------------|-------------------------|
| G639XXNN000 | CABLE |
| G34AWY00000 | SOPORTE CUCHILLA |
| G623N0000000 | TAPA CORREA |
| G55100000000 | CUCHILLA 20" |
| B1001B00032 | TORNILLO CUCHILLA |
| G54N1000000 | RUEDA 11" (TRASERA) |
| G34H1000000 | RUEDA 8" (DELANTERA) |
| BA001B00000 | CORREA |
| G54AL000000 | PIÑÓN IZQ |
| G54AM000000 | PIÑÓN DCH |
| G34GT000000 | TRACCION |
| G21K1000000 | SACO CESTO |
| 193490527-0003 | ARRANQUE COMPLETO |

| | |
|----------------|------------------------------|
| 170022364-0001 | CARBURADOR |
| 270920529-0001 | BOBINA |
| 270020277-0002 | PLATO MAGNETICO |
| 180130178-0001 | FILTRO DE AIRE COM- PLETO |
| 170870156-0001 | TAPON GASOLINA |

Descripción y usos: Se trata de un cortacésped de gasolina y con un ancho de corte de 508 cm. Cuenta con ajuste de la altura de corte con 6 posiciones. Perfecto para jardines de tamaño medio y pensado para tareas complejas de mantenimiento. Incorpora un recolector de hierba de 65 litros.



SG CORTACESPED 53 SLT

cortacésped

| | |
|-------------------------|--|
| Motor | Loncin |
| Cilindrada | 196 cc |
| Sistema accionamiento | Autopropulsado |
| Ancho de corte | 525 mm |
| Altura de corte | 25-75 mm con 6 posiciones |
| Depósito combustible | 1 L |
| Volumen aceite | 0,6 L |
| Material cubierta | Acero |
| Tamaño rueda delantera | 8 pulgadas |
| Tamaño de rueda trasera | 11 pulgadas |
| Función 3 en 1 | Recogida, mulching, y salida lateral. |
| Material recolector | Plástico |
| Capacidad recolector | 65 L |
| Embalaje | 855 x 570 x 485 mm |



| REFERENCIA | DESCRIPCIÓN |
|----------------|-------------------------|
| G639XXNN000 | CABLE |
| G339XYC0000 | CABLE TRACCION |
| G34AWY00000 | SOPORTE CUCHILLA |
| G623N000000 | TAPA CORREAS |
| G6510000000 | CUCHILLA 21" |
| G3520000000 | ARANDELA CUCHILLA |
| B1001B00032 | TORNILLO CUCHILLA |
| G54N1000000 | RUEDA 11" (TRASERA) |
| G34H3000000 | RUEDA 8" (DELANTERA) |
| B0014W00000 | RODAMIENTO RUEDA |
| G54AL000000 | PIÑÓN IZQ |
| G54AM000000 | PIÑÓN DCH |
| G34GT000000 | TRACCION |
| G19K1000000 | BOLSA TELA CESTO |
| 193490527-0003 | ARRANQUE COMPLETO |
| 170022364-0001 | CARBURADOR |
| 270920529-0001 | BOBINA |
| 270020277-0002 | PLATO MAGNETICO |
| 180130178-0001 | FILTRO DE AIRE COMPLETO |
| 170870156-0001 | TAPON GASOLINA |

Descripción y usos: Este modelo de cortacésped a gasolina es ideal para mantener un jardín de grandes dimensiones. Proporciona al usuario durabilidad, resultados profesionales y grandes prestaciones por un precio excepcional, para profesionales y propietarios de grandes extensiones que buscan un precio económico.



WY28XE11BS

cortacésped walk behind

| | |
|---------------------------|---|
| Marca motor | B&S |
| Modelo de motor | 21R7 |
| Cilindrada | 344CC |
| Potencia del motor | 10,5 CV |
| Arranque | Manual |
| Capacidad de aceite | 1.4 L |
| Tipo de transmisión | Avance de 3 velocidades |
| Embrague de la cortadora | Eléctrico |
| Ancho de corte | 71 cm |
| Cuchillas de corte | 36,8 cm X2 |
| Rango de altura de corte | (3,8-10,2 cm) |
| Posiciones altas de corte | 6 |
| Construcción de cubierta | Acero de 3 mm fabricado con barra de refuerzo frontal |
| Velocidad de avance | 1.85 mph (3 km / h) 2. ° 2.65 mph (4.3 km / h) 3. ° 3.55 mph (5.7 km / h) |
| Velocidad inversa | N / A |
| Neumáticos delanteros | 8X3.00-4 Suave |
| Neumáticos traseros | 13X5.00-6 césped |
| Distancia entre ejes | 33,4' |
| Embalaje | 1240 x 778 x 816 mm |
| Peso total | 154 kg |

| REFERENCIA | DESCRIPCIÓN |
|------------|-----------------------|
| 2832085A | CORREA CUCHILLAS |
| 3202004 | CUCHILLA |
| 2802010 | CORREA |
| 3200001 | CORREA |
| 3600003A | CORREA |
| 2831101 | RUEDA DELANTERA 8"X3" |
| 3205201 | RUEDA TRASERA |
| 2832090 | SOPORTE CUCHILLA |
| 2832187 | MUELLE |
| 2832130 | POLEA TENSORA |
| 5208012 | INTERRUPTOR |
| 2808005 | INTERRUPTOR CUCHILLAS |







WYRZ50XL

cortacésped giro zero

| | |
|--------------------------------------|---|
| Marca motor | LONCIN |
| Modelo de motor | LC2P77F |
| Desplazamiento del motor | 708 cc |
| Potencia del motor | 15,4 kW (20,6 CV) / 3600 rpm |
| Número de cilindros | V-Twin |
| Inicio | Arranque con llave eléctrica |
| Capacidad de aceite | 2,1 litros |
| Capacidad del tanque de gas | 15 L |
| Tipo de transmisión) | Hydro-Gear ZT-2800 |
| Ultima vuelta | Accionamiento hidrostático dual integrado |
| Embrague de la cortadora | Eléctrico |
| Funcion de corte | Descarga lateral |
| Mulching | Opcional |
| Ancho de corte | 1,27 m |
| Cuchillas de corte | 44 cm X3 |
| Rango de altura de corte | 3,8-11,4 cm |
| Posiciones alturas de corte | 7 posiciones / pie operado |
| Velocidad de avance | 7,7 mph (12,4 km / h) |
| Velocidad inversa | 3,4 mph (5,5 km / h) |
| Neumáticos delanteros | 13 X 5.0-6 Suave |
| Neumáticos traseros | 20 x 10.0-8 césped |
| Distancia entre ejes rueda delantera | 30 " |
| Distancia entre ejes rueda trasera | 33,8 " |
| Ruedas | 46,3 " |
| Estructura protectora | Incluída |
| Luz led | Incorporada |
| Embalaje | 2006 x 1380 x 864 mm |
| Peso total | 270 kg |

| REFERENCIA | DESCRIPCIÓN |
|------------|--------------------------|
| 5001305 | POLEA COMPLETA CUCHILLAS |
| 5001001U | CUCHILLA |
| 5001002 | CORREA |
| 5001335 | RUEDAS PLATAFORMA CORTE |
| 5002210 | CABLE FRENO |
| 6012004 | CORREA |
| 4804005A | EMBRAGUE |
| 6012010 | POLEA TENSORA |
| 5208007 | FUSIBLE 20A |
| 5008011 | RELE 12V |
| 463234 | RELE ARRANQUE |

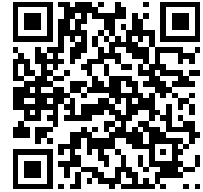

**¿QUIERES VERLO EN FUNCIONAMIENTO?
¡ESCANEA ESTE CÓDIGO QR!**

Descripción y usos: Este modelo de cortacésped a gasolina es ideal para mantener un jardín de grandes dimensiones. Proporciona al usuario durabilidad, resultados profesionales y grandes prestaciones por un precio excepcional, para profesionales y propietarios de grandes extensiones que buscan un precio económico.





SPORTGARDEN 234T

cortasetos

| | |
|----------------|--------------------|
| Cuchilla doble | Manillar giratorio |
|----------------|--------------------|

| | |
|------------|------------------------|
| Motor | Sport Garden |
| Cilindrada | 25,4 cc |
| Potencia | 0,65 kW / 0,9 hp |
| Corte | 600 mm |
| Embalaje | 1.070 x 240 x 260 x mm |
| Peso | 7 kg |



| REFERENCIA | DESCRIPCIÓN |
|------------|----------------------------|
| 234T31 | MANDO COMPLETO |
| 234TN13 | PROTECTOR CUCHILLA |
| 234TN17 | CUCHILLA |
| M234TN13 | EMBRAGUE |
| M234TN1-6 | FILTRO AIRE COMPLETO |
| M234TN29 | BOBINA |
| M234TN32 | JUNTA CILINDRO |
| M234TN33 | AROS PISTON |
| M234TN34 | BULON |
| M234TN35 | PISTON |
| M234TN36 | CLIPS PISTON |
| M234TN37 | RODAMIENTO SUPERIOR BIELA |
| M234TN52 | ARRANQUE COMPLETO |
| M234TN54 | DEPÓSITO GASOLINA COMPLETO |
| M234TN7 | CARBURADOR 234T |

Descripción y usos: cuenta con un preciso corte de hasta 60 cm de ancho, y gracias a su doble cuchilla, le permitirá tener sus setos a punto de manera rápida y cómoda. Además el cortasetos tiene montado un confortable manillar que es oscilante 180 grados para adaptarse a cualquier corte. Recomendado uso doméstico.



SG-CORTASETOS 600

cortasetos

| | |
|----------------|--------------------|
| Cuchilla doble | Manillar giratorio |
|----------------|--------------------|

| | |
|---------------------|---------------------|
| Motor | Sport Garden |
| Cilindrada | 25,4 cc |
| Potencia nominal | 0,75 kW / 1 hp |
| Longitud de la hoja | 600 mm |
| Dep. Combustible | 0,4 L |
| Embalaje | 1170 x 250 x 220 mm |
| Peso | 4,8 kg |



| REFERENCIA | DESCRIPCIÓN |
|---------------|---------------------------|
| SGC600-A2 | EMBRAGUE |
| SGC600-A11 | BOBINA |
| SGC600-A19/24 | ARRANQUE COMPLETO |
| SGC600-A28 | ESCAPE |
| SGC600-A33 | JUNTA CILINDRO |
| SGC600-A34 | AROS |
| SGC600-A35 | CLIP PISTON |
| SGC600-A36 | RODAMIENTO PISTON |
| SGC600-A37 | PISTON |
| SGC600-A38 | BULON |
| SGC600-A44 | CILINDRO |
| SGC600-A51 | CARBURADOR |
| SGC600-A56 | CEBADOR |
| SGC600-A58 | FILTRO AIRE |
| SGC600-A63 | FILTRO GASOLINA |
| SGC600-A65 | TAPON GASOLINA |
| SGC600-A66 | DEPOSITO DE GASOLINA |
| SGC600-B1/17 | MANDO ACELERADOR COMPLETO |
| SGC600-B20 | GUIA CUCHILLAS |

| | |
|------------|-------------------------|
| SGC600-B21 | CUCHILLA INFERIOR |
| SGC600-B23 | GUIA SUPERIOR CUCHILLAS |
| SGC600-B24 | GUIA SUPERIOR CUCHILLAS |
| SGC600-B40 | CUCHILLA SUPERIOR |
| SGC600-B44 | CAMPANA EMBRAGUE |
| SGC600-B49 | ASA |

Descripción y usos: El cortasetos a gasolina SG-CORTASETOS 600 está provisto de un motor de 25,4 cc y un peine de alta calidad con una gran longitud de corte. Cuenta con manillar giratorio de 180° y posee un diseño ergonómico para adaptarse a cualquier corte.



SG EB 800

soplador

| | |
|------------|--------------------|
| Motor | Sport Garden |
| Cilindrada | 79,4 cc |
| Potencia | 3,4 Kw |
| Vel. aire | 92 m/s |
| Embalaje | 530 x 430 x 550 mm |
| Peso | 11 kg |



| REFERENCIA | DESCRIPCIÓN |
|----------------|---------------------|
| EB-800-E.1.1 | CARBURADOR |
| EB-800-E.1.5 | CAMPANA DE ARRANQUE |
| EB-800-E.1.7 | ARRANQUE COMPLETO |
| EB-800-E.1.9 | BOBINA |
| EB-800-E.1-7 | JUNTA CILINDRO |
| EB-800-E.2-1 | FILTRO ESPUMA |
| EB-800-E.2-3 | FILTRO AIRE PAPEL |
| EB-800-E.3 | DEPÓSITO GASOLINA |
| EB-800-E.4-3 | TUBO PUNTA SALIDA |
| EB-800-E.5.3 | VENTILADOR |
| EB-800-E.5-1 | VENTILADOR DE MANDO |
| EB-800-E-CZHZZ | MANDO COMPLETO |
| EB-650.10-CE | ARNES |
| 1E58FL.6-5 | CLIP PISTON |
| 1E53FP.4-2 | KIT AROS |
| EB-800-E.1.5-1 | PISTON |

Descripción y usos: soplador que se puede utilizar en grandes parques o jardines. Para el jardinero o el usuario particular que necesita limpiar macizos de flores, bordillos y áreas verdes de pequeñas y medianas dimensiones. Perfectos para el acabado y la limpieza.



SG EBV 260

soplador - aspirador - triturador

| | |
|-----------------|--------------------|
| Motor | Sport Garden |
| Cilindrada | 25,4 cc |
| Potencia | 0,75 Kw / 7500 rpm |
| Capacidad bolsa | 45 L |
| Vel. aire | 50 m/s |
| Embalaje | 555 x 285 x 385 |
| Peso | 5,2 kg |



| REFERENCIA | DESCRIPCIÓN |
|------------------|---------------------------|
| TT-BV3405A119 | BOLSA RECOLECTORA |
| TT-BV3405A120 | CUCHILLA TRITURADORA |
| TT-BV3405A126 | BOQUILLA SALIDA PLANA |
| TT-BV3405A82 | INTERRUPTOR DE SEGURIDAD |
| TT-BV3405A86 | IMPULSOR |
| TT-BV3405A95-109 | MANDO ACELERADOR COMPLETO |
| TT-BV3405MA15 | CAMPANA ARRANQUE |
| TT-BV3405MA32 | CARBURADOR |
| TT-BV3405MA5 | BOBINA |
| TT-BV3405MA57 | JUNTA CILINDRO |
| TT-BV3405MA58 | AROS PISTON |
| TT-BV3405MA59 | PISTON |
| TT-BV3405MA60 | BULON |
| TT-BV3405MA61 | CLIPS PISTON |
| TT-BV3405MAAR | ARRANQUE COMPLETO |
| TT-BV3405MADP | DEPÓSITO COMPLETO |
| TT-BV3405MAFA | FILTRO AIRE |

Descripción y usos: soplador-aspirador máquina multifunción para la limpieza y el cuidado de áreas verdes, muy cómodo y simple de utilizar, se puede adaptar a varias exigencias. Incorpora además una función de triturado, que te permitirá triturar lo que aspire, consiguiendo aprovechar los 45 L de capacidad de bolsa. Para tareas profesionales de cuidado de calles residenciales, tareas de personal de limpieza de ayuntamientos etc.

SG SULFATADORA BAT/MAN

pulverizadora

A batería y manual

| | |
|--------------------------|--------------------|
| Capacidad | 16 L |
| Batería | 12 V 8 Ah / Ácido |
| Presión | 0-15- 1 mpa |
| Lanza | inox |
| Controlador de velocidad | si |
| Cargador | 1.0A |
| Embalaje | 400 x 200 x 530 mm |
| Peso | 6,8 kg |

2 en 1
batería y
manual



| REFERENCIA | DESCRIPCIÓN |
|--------------|-------------------------------------|
| A001005 | TOMA CARGA SULF ELECTRICA |
| A001009004 | POTENCIOMETRO SULFATADORA ELECTRICA |
| A001009006 | RUEDA POTENCIOMETRO SULF ELECTRICA |
| A001010002 | VOLTIMETRO SULF ELECTRICA |
| A001011 | TUBO ENTR SULF ELECTRICA |
| A001012002 | TUBO SALIDA SULF ELECTRICA |
| A001013001 | BOMBA SULF ELECTRICA |
| A001014001 | BATERIA SULF ELECTRICA |
| A001018 | ARNES SULF ELECTRICA |
| A001019 | FILTRO DEP SULF ELECTRICA |
| A001024003 | CARGADOR SULF ELECTRICA |
| A001DEPÓSITO | DEPÓSITO SULFATADORA ELECTRICA |
| A001TAPA | TAPA SULFATADORA ELECTRICA |
| A001TAPAP | TAPA SULFATADORA ELECTRICA PEQ |
| A005012 | BOQUILLA SULF ELECTRICA |
| A005016 | INTERRUPTOR SULF ELECTRICA |

Descripción y usos: soplador-aspirador máquina multifunción para la limpieza y el cuidado de áreas verdes, muy cómodo y simple de utilizar, se puede adaptar a varias exigencias. Para tareas profesionales de cuidado de calles residenciales, tareas de personal de limpieza de ayuntamientos etc.



SG 16D

pulverizadora

A batería

| | |
|-----------------|--------------------|
| Motor | Eléctrico |
| Capacidad | 16 L |
| Batería | 12 Ah- de litio |
| Presión | 1,5 - 4 bar |
| Tiempo de carga | 8 horas |
| Autonomía | 4-6 horas |
| Embalaje | 390 x 200 x 500 mm |
| Peso | 6,5 kg |

recambios:

- 1- A001022001 MANETA SULF ELECTRICA 1
- 2- A001023 LANZA SULF ELECTRICA 2
- 3- A001029 BOQUILLA SULF ELECTRICA 3
- 4- A001027 BOQUILLA DOBLE SULF ELECTRICA 4
- 5- A001030 BOQUILLA SULF ELECTRICA 5
- 6- A005012 BOQUILLA SULF ELECTRICA 6



| REFERENCIA | DESCRIPCIÓN |
|--------------|-------------------------------------|
| A001005 | TOMA CARGA SULF ELECTRICA |
| A001009004 | POTENCIOMETRO SULFATADORA ELECTRICA |
| A001009006 | RUEDA POTENCIOMETRO SULF ELECTRICA |
| A001010002 | VOLTIMETRO SULF ELECTRICA |
| A001011 | TUBO ENTR SULF ELECTRICA |
| A001012002 | TUBO SALIDA SULF ELECTRICA |
| A001013001 | BOMBA SULF ELECTRICA |
| A001014001 | BATERIA SULF ELECTRICA |
| A001018 | ARNES SULF ELECTRICA |
| A001019 | FILTRO DEP SULF ELECTRICA |
| A001024003 | CARGADOR SULF ELECTRICA |
| A001DEPÓSITO | DEPÓSITO SULFATADORA ELECTRICA |
| A001TAPA | TAPA SULFATADORA ELECTRICA |
| A001TAPAP | TAPA SULFATADORA ELECTRICA PEQ |
| A005012 | BOQUILLA SULF ELECTRICA |
| A005016 | INTERRUPTOR SULF ELECTRICA |

Descripción y usos: Realice trabajos de fumigación, limpieza y abono de forma fácil y cómoda con el pulverizador a batería. La palanca de pulverización es fácil de usar con una sola mano. Con el robusto tubo rociador conseguirá un riego homogéneo. Puede pasar de una fina niebla pulverizada a un chorro potente con sólo girar la boquilla.



SG P60T

carretilla pulverizadora

Bomba de pistón

| | |
|----------|--------------------|
| Motor | Sport Garden 2T |
| Potencia | 26 cc |
| Presión | 24 bar |
| Caudal | 6-8 L/min |
| Depósito | 60 L |
| Manguera | 30 m |
| Embalaje | 860 x 430 x 800 mm |
| Peso | 30 kg |



| REFERENCIA | DESCRIPCIÓN |
|------------|-------------------------|
| SG210003 | CARBURADOR |
| SG210004 | FILTRO DE AIRE COMPLETO |
| SG210005 | EMBRAGUE COMPLETO |
| SG210009 | ARRANQUE COMPLETO |
| SG210010 | DEPÓSITO COMPLETO |
| SG210011 | BOMBA COMPLETA |
| SG210033 | POLEA ARRANQUE |
| SG210034 | FILTRO DEPÓSITO SULF |
| SG210040 | INTERRUPTOR APAGADO |
| SG210041 | TAPON DEPÓSITO |
| SG210043 | JUNTA CILINDRO |
| SG210044 | KIT AROS PISTON |
| SG210045 | PISTON MOTOR |
| SG210046 | RODAMIENTO PISTON |
| SG210047 | BULON |
| SG210048 | CLIPS PISTON KIT |
| SG210049 | BOBINA ENCENDIDO |
| P60TN8 | ENROLLADOR CARRETILLA |
| SG D-B5 | LANZA PARA SULFATADORA |

Descripción y usos: gracias a su sistema de ruedas muy robustas y su estructura con asa trasera, es fácilmente manejable y muy estable sobre terrenos pendientes e irregulares. El robusto y espacioso tanque de 60 litros permite de no tener que hacer continuos llenados. Además cuenta con manguera de larga extensión de 30 metros capaz de cubrir un huerto, vergel u olivar de medio-grandes dimensiones, o también dentro de grandes invernaderos.



SG CARRETILLA 2T

carretilla pulverizadora

Bomba de pistón

| | |
|----------|---------------------|
| Motor | Sport Garden 2T |
| Potencia | 26 cc |
| Presión | 20 bar |
| Caudal | 20 L/min |
| Depósito | 100 L |
| Manguera | 10 m |
| Embalaje | 1100 x 500 x 800 mm |
| Peso | 22 kg |
| Ruedas | 1 |



EQUIPAMIENTO OPCIONAL

referencia: 250
pistola m.94
Entrada: 1/2M

EQUIPAMIENTO INCLUIDO



| REFERENCIA | DESCRIPCIÓN |
|------------|-------------------------|
| SG210003 | CARBURADOR |
| SG210004 | FILTRO DE AIRE COMPLETO |
| SG210005 | EMBRAGUE COMPLETO |
| SG210009 | ARRANQUE COMPLETO |
| SG210010 | DEPÓSITO COMPLETO |
| SG210011 | BOMBA COMPLETA |
| SG210033 | POLEA ARRANQUE |
| 8060001 | FILTRO DEPÓSITO SULF |
| SG210040 | INTERRUPTOR APAGADO |
| SG210041 | TAPON DEPÓSITO |
| SG210043 | JUNTA CILINDRO |
| SG210044 | KIT AROS PISTON |
| SG210045 | PISTON MOTOR |
| SG210046 | RODAMIENTO PISTON |
| SG210047 | BULON |
| SG210048 | CLIPS PISTON KIT |
| SG210049 | BOBINA ENCENDIDO |
| 250 | PISTOLA M.94 |

Equipamiento opcional carretillas

SG CARRETILLA 2T/4T/2R 4T



enrollador + soporte
603+AI154



manguera
9150480840000

Medidas øint 8 mm
 øext 14 mm

Longitud 100 m



Descripción y usos: Carretilla pulverizadora Sport Garden con motor de 2 tiempos, perfecto para adaptar tu modo de sulfatar o fumigar. El robusto y espacioso tanque de 100 litros te proporcionará una gran autonomía al no tener que hacer continuos llenados.



SG CARRETILLA 4T

carretilla pulverizadora

| | |
|----------|---------------------|
| Motor | Loncin 4T |
| Potencia | 2,5 hp |
| Presión | 20 bar |
| Caudal | 20 L/min |
| Depósito | 100 L |
| Manguera | 10 m |
| Embalaje | 1100 x 500 x 800 mm |
| Peso | 22 kg |
| Ruedas | 1 |



EQUIPAMIENTO OPCIONAL

referencia: 250
pistola m.94
Entrada: 1/2M

EQUIPAMIENTO INCLUIDO



| REFERENCIA | DESCRIPCIÓN |
|----------------|-------------------------------------|
| 250 | PISTOLA M.94 |
| 170021486-0001 | CARBURADOR LC152F-1 |
| 170501254-0001 | DEPÓSITO GASOLINA LC152F-1 |
| 170720002-0001 | FILTRO GASOLINA LC152F-1 |
| 180100058-0001 | FILTRO AIRE LC152F-1 |
| 180571362-0001 | ESCAPE LC152F-1 |
| 193500040-0001 | ARRANQUE LC152F-1 |
| 270920341-0001 | BOBINA LC152F-1 |
| DP201011 | MEMBRANA CALDERIN |
| DP201012 | TAPA MEMBRANA CALDERIN |
| DP201041 | DIAFRAGMA |
| DPA0001 | VALVULA DE REGULACION |
| DPA0002 | REDUCTOR |
| GMBF 20 | BOMBA DE DIAFRAGMA GMBF20 CON REDUC |

Equipamiento opcional carretillas

SG CARRETILLA 2T/4T/2R 4T



enrollador + soporte
603+AI154



manguera
9150480840000

Medidas øint 8 mm
øext 14 mm
Longitud 100 m



Descripción y usos: carretilla pulverizadora con motor Loncin de 4 tiempos. Apta para uso en huertas, autonomía y versatilidad de uso. Realice trabajos de fumigación en huertos, fincas o grandes plantaciones.



SG CARRETILLA 2R 4T

carretilla pulverizadora

| | |
|----------|---------------------|
| Motor | Loncin 4T |
| Potencia | 2,5 hp |
| Presión | 20 bar |
| Caudal | 20 L/min |
| Depósito | 100 L |
| Manguera | 10 m |
| Embalaje | 1100 x 500 x 800 mm |
| Peso | 22 kg |
| Ruedas | 2 |



EQUIPAMIENTO OPCIONAL

referencia: 250
pistola m.94
Entrada: 1/2M

EQUIPAMIENTO INCLUIDO



| REFERENCIA | DESCRIPCIÓN |
|----------------|-------------------------------------|
| 250 | PISTOLA M.94 |
| 170021486-0001 | CARBURADOR LC152F-1 |
| 170501254-0001 | Depósito GASOLINA LC152F-1 |
| 170720002-0001 | FILTRO GASOLINA LC152F-1 |
| 180100058-0001 | FILTRO AIRE LC152F-1 |
| 180571362-0001 | ESCAPE LC152F-1 |
| 193500040-0001 | ARRANQUE LC152F-1 |
| 270920341-0001 | BOBINA LC152F-1 |
| DP201011 | MEMBRANA CALDERIN |
| DP201012 | TAPA MEMBRANA CALDERIN |
| DP201041 | DIAFRAGMA |
| DPA0001 | VALVULA DE REGULACION |
| DPA0002 | REDUCTOR |
| GMBF 20 | BOMBA DE DIAFRAGMA GMBF20 CON REDUC |

Equipamiento opcional carretillas

SG CARRETILLA 2T/4T/2R 4T



enrollador + soporte
603+AI154



manguera
9150480840000

Medidas øint 8 mm
 øext 14 mm
Longitud 100 m

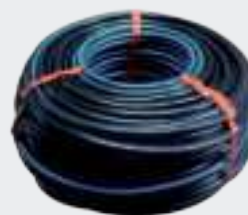

Descripción y usos: Ideal para aplicaciones de jardinería donde es necesaria potencia, robustez y fiabilidad. Grupo de pulverización silencioso, lo que la convierte en un útil adecuado para trabajos de jardinería en lugares habitados.



NUEVO

AI206

barra herbicida modelo Xena Plus

- Regulador de presión manual
- Manómetro con glicerina
- Filtro de impulsión fabricado en latón
- Todas las boquillas cuentan con antigota y grifo.
- Homologación CE.
- Dimensión cerrada y dimensión abierta
- Cobertura de trabajo 10 m
- Dimensión cerrada 130 cm
- Dimensión abierta 230 cm

Equipada con: 2 boquillas en los extremos de largo alcance ,4 boquillas centrales fabricadas en cerámica y antideriva.



Descripción y usos: MODELO XENA PLUS.Indicada para aplicaciones de herbicida en olivar, frutales, viña y cereal Enganche a través de 2 puntos de fijación.Chasis fabricado en acero.



NUEVO

AI207

barra herbicida modelo Xena Master

- Regulador de presión manual
- Manómetro con glicerina
- Filtro de impulsión fabricado en latón
- Todas las boquillas cuentan con antigota y grifo.
- Homologación CE.
- Dimensión cerrada y dimensión abierta
- Cobertura de trabajo 10 m
- Dimensión cerrada 130 cm
- Dimensión abierta 230 cm

Equipada con: 2 boquillas en los extremos de largo alcance y una boquilla central de espejo en cerámica.



Descripción y usos: MODELO XENA MASTER.Indicada para aplicaciones de herbicida en olivar, frutales, viña y cereal. Enganche a través de 2 puntos de fijación.Chasis fabricado en acero.

**AI201****NUEVO**

barra herbicida modelo Xena Evo

Regulador de presión manual

Manómetro con glicerina

Filtro de impulsión fabricado en latón

Todas las boquillas cuentan con antigota y grifo.

Homologación CE.

Dimensión cerrada y dimensión abierta

Cobertura de trabajo 12 m

Dimensión cerrada 130 cm

Dimensión abierta 230 cm

Dimensión abierta total 350 cm



Equipada con: 2 boquillas de largo alcance en los extremos, 4 boquillas centrales fabricadas en cerámica y antideriva + 2 boquillas de fin de rampa en cerámica y antideriva.

Descripción y usos: MODELO XENA EVO. Indicada para aplicaciones de herbicida en olivar, frutales, viña y cereal. Engranche a través de 2 puntos de fijación. Chasis fabricado en acero EXTENSIBLE mediante palomillas de fijación.

NUEVO**C26V14E570**

Cuerpo en latón

Rosca 1/2"

Presión 40 bar

NUEVO**615101**

Sistema automático para la apertura de una electroválvula de corte.

Funcionamiento manual.

Pantalla con led

NUEVO**615101**

Sistema automático para la apertura de dos electroválvulas de corte.

Funcionamiento manual.

Pantalla con led.



ST 10A SP

motobomba

| | |
|--------------------|--------------------|
| Motor | Sport Garden 2T |
| Potencia | 1,5 hp |
| Max. elevación | 22 m |
| ∅ Entrada / Salida | 1" (25 mm) |
| Aspiración | 4 m |
| Caudal | 120 L/min |
| Embalaje | 310 x 295 x 315 mm |
| Peso | 10 kg |



| REFERENCIA | DESCRIPCIÓN |
|-------------|--------------------------|
| WP10A10 | CUERPO BOMBA |
| WP10A12 | JUNTA VÁLVULA ASPIRACIÓN |
| WP10A13 | TOBERA ENTRADA AGUA |
| WP10A15 | JUNTA TAPÓN DRENAJE |
| WP10A16 | TAPÓN DRENAJE |
| WP10A17 | JUNTA RACOR SALIDA |
| WP10A19 | RACOR SALIDA BOMBA |
| WP10A2 | TAPA CUERPO BOMBA |
| WP10A21 | RACOR SALIDA |
| WP10A22 | ABRAZADERA |
| WP10A23 | FILTRO ASPIRACIÓN |
| WP10A5 | RETÉN MECÁNICO |
| WP10A6 | ASPA PROPULSORA |
| WP10A7 | GUIA DE AGUA |
| WP10A8 | JUNTA TÓRICA MOTOBOMBA |
| WP10A9 | JUNTA CUERPO BOMBA |
| WP10AFILTRO | FILTRO ASPIRACIÓN |
| WP10AJ | JUNTA RACOR SALIDA |
| WP10AT | TUERCA RACOR SALIDA |

| | |
|------------|----------------------|
| IE40F68 | CARBURADOR |
| IE40F72-81 | FILTRO AIRE COMPLETO |
| IE40F83 | ARRANQUE COMPLETO |
| IE40F88 | Depósito COMPLETO |

Descripción y usos: ST 10A SP la motobomba ideal para los suministros con agua, drenar o regar. Gracias a su construcción ligera y diseño compacto, esta motobomba de agua se puede almacenar en el cobertizo del jardín, garaje, o incluso en una camioneta en caso de uso portátil. 4 metros en total incluyendo entrada y salida.



ST 15B SP

motobomba

| | |
|--------------------|--------------------|
| Motor | Sport Garden 4T |
| Potencia | 2,5 hp |
| Max. elevación | 25 m |
| Ø Entrada / Salida | 1,5" (40mm) |
| Aspiración | 6 m |
| Caudal | 190 L/min |
| Embalaje | 340 x 270 x 285 mm |
| Peso | 13 kg |



| REFERENCIA | DESCRIPCIÓN |
|----------------|--------------------------|
| WP15C10 | CUERPO BOMBA |
| WP15C16 | TOBERA ENTRADA AGUA |
| WP15C17 | JUNTA VÁLVULA ASPIRACIÓN |
| WP15C18 | JUNTA TAPÓN DRENAJE |
| WP15C19 | TAPÓN DRENAJE |
| WP15C2 | TAPA CUERPO BOMBA |
| WP15C20 | RACOR SALIDA BOMBA |
| WP15C21 | JUNTA RACOR SALIDA |
| WP15C3 | ARANDELA D.6 |
| WP15C5 | RETÉN MECÁNICO |
| WP15C6 | ASPA PROPULSORA |
| WP15C7 | GUIA DE AGUA |
| WP15C8 | JUNTA TÓRICA |
| WP15C9 | JUNTA CUERPO BOMBA |
| WP15CRACOR | RACOR SALIDA |
| WP15CTUERCA | TUERCA RACOR |
| 193490001-0001 | ARRANQUE COMPLETO |
| 270920171-0001 | BOBINA |
| 170020422-0001 | CARBURADOR |
| 180020323-0001 | FILTRO AIRE COMPLETO |

Descripción y usos: motobomba extremadamente ligera y manejable. La opción perfecta para pequeñas labores de jardinería, pequeños transvases, carga de agua en hormigoneras, etc. Incorpora una asa para mayor manejo de carga. 6 metros en total incluyendo entrada y salida.



ST 20A SP

motobomba

| | |
|--------------------|--------------------|
| Motor | Sport Garden 4T |
| Potencia | 5,5 hp |
| Max. elevación | 30 m |
| Ø Entrada / Salida | 2" (50mm) |
| Aspiración | 6 m |
| Caudal | 500 L/min |
| Embalaje | 465 x 435 x 385 mm |
| Peso | 24 kg |



| REFERENCIA | DESCRIPCIÓN |
|----------------|--------------------------|
| WP20A1 | TAPA CUERPO BOMBA |
| WP20A10 | JUNTA RACOR SALIDA |
| WP20A13 | JUNTA TAPÓN DRENAJE |
| WP20A14 | TAPÓN DRENAJE |
| WP20A15 | TUERCA RACOR |
| WP20A16 | RACOR SALIDA BOMBA |
| WP20A17 | JUNTA RACOR |
| WP20A18 | RACOR SALIDA BOMBA |
| WP20A19 | TOBERA ENTRADA AGUA |
| WP20A2 | JUNTA CUERPO BOMBA |
| WP20A20 | JUNTA VÁLVULA ASPIRACIÓN |
| WP20A25 | FILTRO ASPIRACIÓN |
| WP20A5 | RETÉN MECÁNICO |
| WP20A6 | ASPA PROPULSORA |
| WP20A7 | GUIA DE AGUA |
| WP20A8 | JUNTA TÓRICA MOTOBOMBA |
| WP20A9 | CUERPO BOMBA |
| 193490011-0001 | ARRANQUE COMPLETO |
| 170020406-0001 | CARBURADOR |
| 270920162-0001 | BOBINA |
| SG30019 | FILTRO AIRE |

Descripción y usos: Ideal para pequeñas labores de riego, transvases, traspasar agua de un pozo a otro. 6 metros en total incluyendo entrada y salida.



ST 30A SP

motobomba

| | |
|--------------------|--------------------|
| Motor | Sport Garden 4T |
| Potencia | 6,5 hp |
| Max. elevación | 32 m |
| Ø Entrada / Salida | 3" (80mm) |
| Aspiración | 6 m |
| Caudal | 1000 L/min |
| Embalaje | 465 x 435 x 385 mm |
| Peso | 26 kg |



| REFERENCIA | DESCRIPCIÓN |
|------------|--------------------------|
| WP30A1 | TAPA CUERPO BOMBA |
| WP30A10 | JUNTA RACOR SALIDA |
| WP30A13 | JUNTA TAPÓN DRENAJE |
| WP30A14 | TAPÓN DRENAJE |
| WP30A15 | TUERCA RACOR |
| WP30A16 | RACOR SALIDA |
| WP30A17 | JUNTA RACOR |
| WP30A18 | RACOR SALIDA BOMBA |
| WP30A19 | TOBERA ENTRADA AGUA |
| WP30A2 | JUNTA CUERPO BOMBA |
| WP30A20 | JUNTA VÁLVULA ASPIRACIÓN |
| WP30A25 | FILTRO ASPIRACIÓN |
| WP30A5 | RETÉN MECÁNICO |
| WP30A6 | ASPA PROPULSORA |
| WP30A7 | GUIA DE AGUA |
| WP30A8 | JUNTA TÓRICA MOTO-BOMBA |

| WP30A9 | CUERPO BOMBA |
|----------------|-------------------|
| 193490011-0001 | ARRANQUE COMPLETO |
| 170020406-0001 | CARBURADOR |
| 270920162-0001 | BOBINA |
| SG30019 | FILTRO AIRE |

Descripción y usos: Su potente motor de 6,5 Hp permite desplazar hasta 1000 L/min. Ideal para pequeñas labores de riego, transvases, estanques. 32 metros en total incluyendo entrada y salida.



ST 15AR 75 SP - PRESIÓN 75 M

motobomba

| | |
|--------------------|--------------------|
| Motor | Sport Garden 4T |
| Potencia | 6,5 hp |
| Max. elevación | 75 m |
| Ø Entrada / Salida | 1,5" (40mm) |
| Aspiración | 7 m |
| Caudal | 1200 L/min |
| Embalaje | 500 x 415 x 425 mm |
| Peso | 25 kg |



| REFERENCIA | DESCRIPCIÓN |
|------------|------------------------------|
| BS15AR-1 | TAPA BOMBA |
| BS15AR-10 | TUERCA RACORD |
| BS15AR-11 | CODO SALIDA |
| BS15AR-12 | TAPON |
| BS15AR-13 | TORICA TAPON |
| BS15AR-15 | JUNTA ENTRADA AGUA |
| BS15AR-16 | ACOPLE RACOR ENTRADA |
| BS15AR-2 | JUNTA TAPA BOMBA |
| BS15AR-3 | RETEN MECANICO |
| BS15AR-4 | ROTOR |
| BS15AR-5 | ESTATOR |
| BS15AR-53 | FILTRO COMPLETO |
| BS15AR-58 | FILTRO AIRE |
| BS15AR-6 | TORICA CARCASA |
| BS15AR-7 | CARCASA |
| BS15AR-8 | JUNTA RACORD SALIDA |
| BS15AR-9 | RACOR SALIDA ACOPLA MANGUERA |

| | |
|----------------|-------------------|
| 193490011-0001 | ARRANQUE COMPLETO |
| 170020406-0001 | CARBURADOR |
| 270920162-0001 | BOBINA |
| SG30019 | FILTRO AIRE |

Descripción y usos: Su potente motor de 6,5 Hp permite desplazar hasta 1000 L/min. Ideal para pequeñas labores de riego, transvases, estanques. 75 metros en total incluyendo entrada y salida.



BJ 45/75

bomba de superficie

AGUAS LIMPIAS FRÍAS

| | |
|----------------|--------------------|
| Potencia | 1.100 w |
| Aspiración | 8 m |
| Max. elevación | 45 m |
| Caudal | 75 L/min |
| Ø salida | 1" |
| Embalaje | 360 x 250 x 180 mm |
| Peso | 7 kg |



RENDIMIENTO

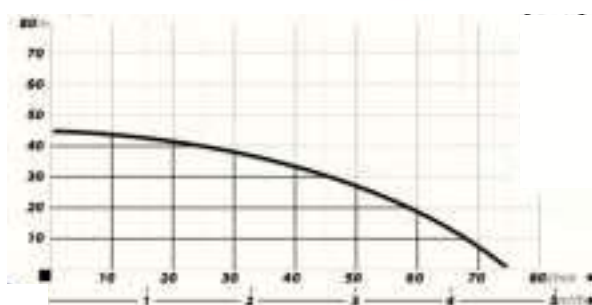

Descripción y usos: bomba de superficie monofasica con un caudal maximo de 75 l/min. Suministro de agua a casas, casas de vacaciones, parcelas y jardines. Cuando se combinan con tanques de presión, las bombas se pueden utilizar para viviendas residenciales unifamiliares y multifamiliares y en aplicaciones industriales.



JET 100A

bomba de superficie

AGUAS LIMPIAS FRÍAS

| | |
|----------------|--------------------|
| Potencia | 1.100 w |
| Aspiración | 8 m |
| Max. elevación | 50 m |
| Caudal | 60 L/min |
| Ø salida | 1" |
| Embalaje | 390 x 200 x 180 mm |
| Peso | 11,5 kg |



RENDIMIENTO

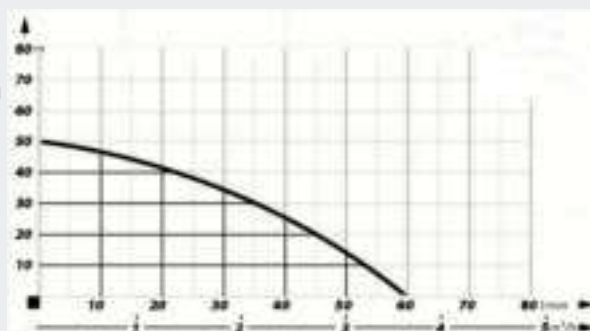

Descripción y usos: Bomba de superficie monofasica con un caudal maximo de 60 l/min. Suministro de agua a casas, casas de vacaciones, parcelas y jardines. Cuando se combinan con tanques de presión, las bombas se pueden utilizar para viviendas unifamiliares y multifamiliares, en aplicaciones industriales y con fines de riego.



AJ 50/60

bomba de superficie

| | |
|----------------|--------------------|
| Potencia | 1.100 w |
| Aspiración | 8 m |
| Max. elevación | 50 m |
| Caudal | 60 L/min |
| ø salida | 1" |
| Embalaje | 370 x 210 x 200 mm |
| Peso | 10,5 kg |



AGUAS LIMPIAS FRÍAS



Descripción y usos: Es una bomba autocebante centrífuga de una etapa, equipada con un sistema que mejora su rendimiento de cebado debido al uso de un tubo Venturi. El cuerpo de la bomba está hecha de acero inoxidable. Suministro de agua a casas, casas de vacaciones, parcelas y jardines. Cuando se combinan con tanques de presión, las bombas se pueden utilizar para viviendas unifamiliares y multifamiliares, en aplicaciones industriales y con fines de riego.



IPC 550

bomba sumergibles

AGUAS LIMPIAS O POCO SUCIAS

| | |
|----------------|--------------|
| Potencia | 500 w |
| Aspiración | 8 m |
| Max. elevación | 7,5 m |
| Caudal | 133 L/min |
| ø salida | 1-1,5" |
| Embalaje | 220 x 390 mm |
| Peso | 10,5 kg |



Descripción y usos: bomba para achique de aguas limpias en pozos, fosas, aljibes, estanques, piscinas, etc. Se suministra con interruptor de nivel. Drenaje de habitaciones inundadas, piscinas, pozos. Las bombas se pueden utilizar en pozos de agua y para obtener agua de tomas con superficie de agua cercana al nivel del suelo. Las bombas también se pueden utilizar para bombear agua de lluvia.



IP 750

bombas sumergibles

AGUAS SUCIAS

| | |
|-------------------|--------------|
| Potencia | 750 w |
| Max. elevación | 8 m |
| Caudal | 210 L/min |
| Ø salida | 1-1,5" |
| Ø paso de sólidos | 30 mm |
| Embalaje | 230 x 330 mm |
| Peso | 4,3 kg |



RENDIMIENTO



Descripción y usos: Drenaje de habitaciones inundadas, piscinas, pozos. Las bombas se pueden utilizar en pozos de agua y para obtener agua de tomas con superficie de agua cercana al nivel del suelo. Las bombas también se pueden utilizar para bombear agua de lluvia..



IP 1100

bomba sumergibles

AGUAS SUCIAS

| | |
|-------------------|--------------|
| Potencia | 1.100 w |
| Max. elevación | 9,5 m |
| Caudal | 250 L/min |
| Ø salida | 1-1,5" |
| Ø paso de sólidos | 30 mm |
| Embalaje | 230 x 350 mm |
| Peso | 5 kg |



RENDIMIENTO

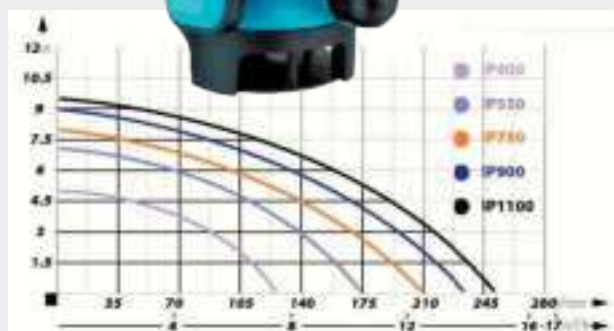

Descripción y usos: Drenaje de habitaciones inundadas, piscinas, pozos. Las bombas se pueden utilizar en pozos de agua y para obtener agua de tomas con superficie de agua cercana al nivel del suelo. Las bombas también se pueden utilizar para bombear agua de lluvia..



IP 750 INOX

electrobomba sumergible

AGUAS SUCIAS

| | |
|-------------------|--------------|
| Potencia | 750 w |
| Max. elevación | 8 m |
| Caudal | 210 L/min |
| Ø salida | 1-1,5" |
| Ø paso de sólidos | 30 mm |
| Embalaje | 230 x 330 mm |
| Peso | 4,3 kg |



RENDIMIENTO

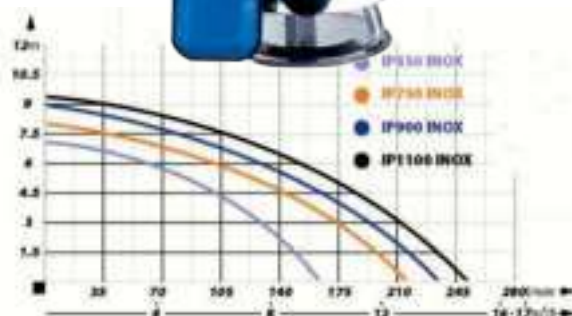

Descripción y usos: Drenaje de habitaciones inundadas, piscinas, pozos. Las bombas se pueden utilizar en pozos de agua y para obtener agua de tomas con superficie de agua cercana al nivel del suelo. Las bombas también se pueden utilizar para bombear agua de lluvia..



IP 1100 INOX

electrobomba sumergible

AGUAS SUCIAS

| | |
|-------------------|--------------|
| Potencia | 1100 w |
| Max. elevación | 9,5 m |
| Caudal | 250 L/min |
| Ø salida | 1-1,5" |
| Ø paso de sólidos | 30 mm |
| Embalaje | 230 x 350 mm |
| Peso | 5 kg |



RENDIMIENTO

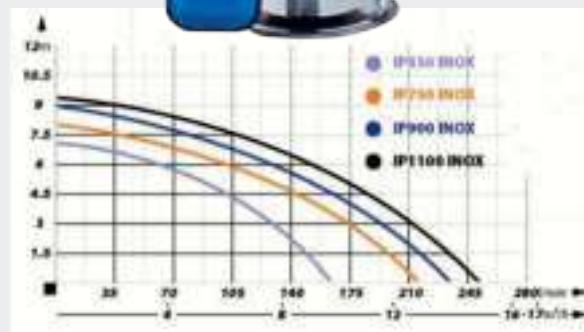

Descripción y usos: Drenaje de habitaciones inundadas, piscinas, pozos. Las bombas se pueden utilizar en pozos de agua y para obtener agua de tomas con superficie de agua cercana al nivel del suelo. Las bombas también se pueden utilizar para bombear agua de lluvia..



MADE IN EUROPE

MULTI IP 1000 INOX

electrobomba sumergible

AGUAS LIMPIAS FRÍAS

| | |
|-------------------|--------------|
| Potencia | 1000 w |
| Max. elevación | 34 m |
| Caudal | 100 L/min |
| Ø salida | 1,5" |
| Ø paso de sólidos | 0,5 mm |
| Embalaje | 180 x 410 mm |
| Peso | 10 kg |



RENDIMIENTO

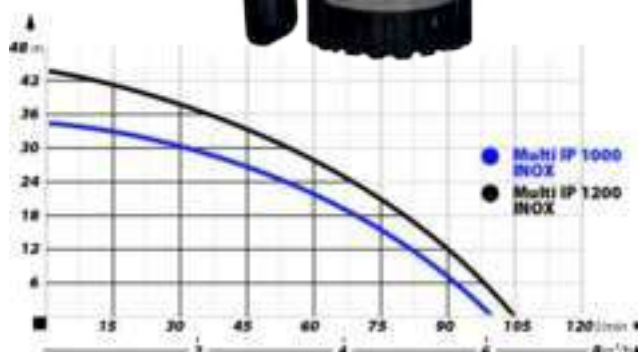

Descripción y usos: Suministro de agua a las casas de pozos circulares y para sistemas de riego de jardines. Las bombas se pueden utilizar en pozos de agua y para obtener agua de tomas con superficie de agua cercana al nivel del suelo.



MADE IN EUROPE

MULTI IP 1200 INOX

electrobomba sumergible

AGUAS LIMPIAS FRÍAS

| | |
|-------------------|--------------|
| Potencia | 1200 w |
| Max. elevación | 44 m |
| Caudal | 105 L/min |
| Ø salida | 1,5" |
| Ø paso de sólidos | 0,5 mm |
| Embalaje | 180 x 410 mm |
| Peso | 10 kg |



RENDIMIENTO

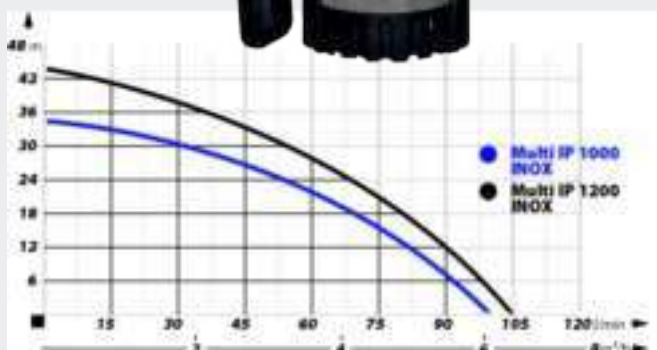

Descripción y usos: Suministro de agua a las casas de pozos circulares y para sistemas de riego de jardines. Las bombas se pueden utilizar en pozos de agua y para obtener agua de tomas con superficie de agua cercana al nivel del suelo.



OLA INOX 60/60

electrobombas



AGUAS LIMPIAS FRÍAS

| | |
|----------------|-------------|
| Potencia | 800 w |
| Max. elevación | 72 m |
| Caudal | 60 L/min |
| Ø salida | 1" |
| Embalaje | 96 x 680 mm |
| Peso | 11,5 kg |



RENDIMIENTO

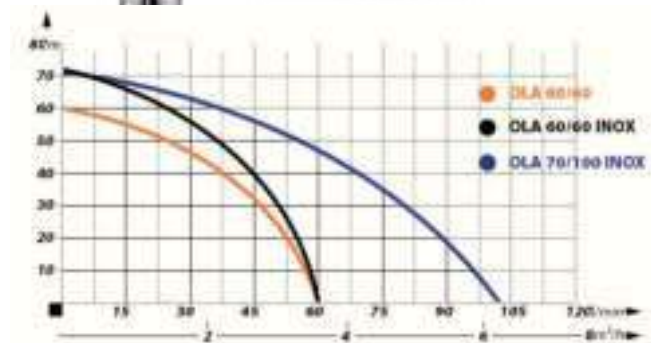

Descripción y usos: Bombeo de agua de pozos circulares, pozos de aguas profundas, lagos y ríos. Suministro de agua potable (grifo) a casas vacacionales y unifamiliares. Riego de jardines.



OLA INOX 70/100

electrobombas



AGUAS LIMPIAS FRÍAS

| | |
|----------------|-------------|
| Potencia | 1100 w |
| Max. elevación | 71 m |
| Caudal | 100 L/min |
| Ø salida | 1" |
| Embalaje | 98 x 770 mm |
| Peso | 13,4 kg |



RENDIMIENTO

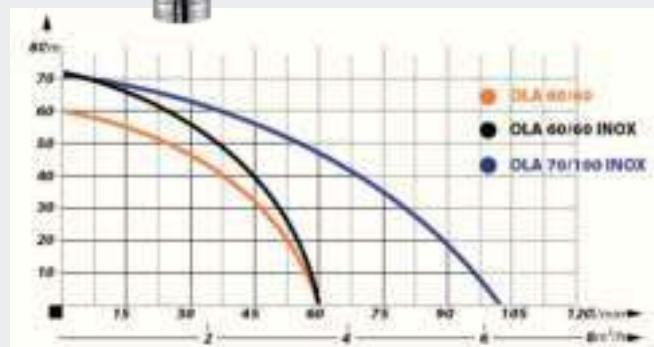

Descripción y usos: Bombeo de agua de pozos circulares, pozos de aguas profundas, lagos y ríos. Suministro de agua potable (grifo) a casas vacacionales y unifamiliares. Riego de jardines.



SWQ 1300

bomba sumergible

Molino para residuos



| | |
|----------------|--------------|
| Potencia | 1300 w |
| Max. elevación | 10 m |
| Caudal | 417 L/min |
| Ø salida | 2" |
| Embalaje | 250 x 480 mm |
| Peso | 12,5 kg |



RENDIMIENTO

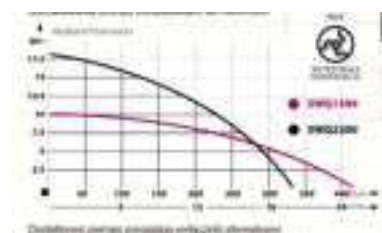

Descripción y usos: Bombeo de agua de pozos circulares, pozos de aguas profundas, lagos y ríos. Suministro de agua potable (grifo) a casas vacacionales y unifamiliares. Riego de jardines.





PC-SK2 (PRESOSTATO)

| | |
|----------------|---------------|
| Presión | 1,6-4,6 bares |
| Max.intensidad | 12 A |
| Voltaje | 230/400 V |
| Diámetro | 1/4 pulgadas |
| Tipo de hilo | GW/ GZ |



Descripción y usos: Bombeo de agua de pozos circulares, pozos de aguas profundas, lagos y ríos. Suministro de agua potable (grifo) a casas vacacionales y unifamiliares. Riego de jardines.



BOMBA PISCINA

| | |
|----------------|-----------|
| Potencia | 900 w |
| Max. elevación | 15,5 m |
| Ø salida | 2-1,4" |
| Caudal | 355 L/min |
| Peso | 10,5 Kg |



RENDIMIENTO

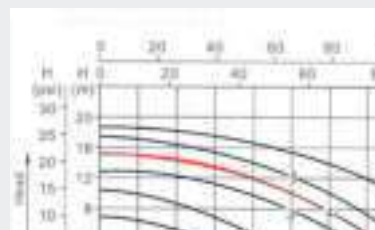

Descripción y usos: Diseñado para la máxima eficiencia de filtración y circulación de agua con contenido de cloro. Puede funcionar con agua de mar. La bomba está fabricada con materiales plásticos, con un recogedor de hojas e impurezas más grandes, incluidas las fibrosas. Disponible con entradas / salidas de Ø 50 mm o Ø 48,5 mm.



DEPÓSITO 24 L

| | |
|------------------------|-----------------|
| Temperatura de trabajo | 0-45° |
| Presión | 8 bar |
| Presión de precarga | 1,7 bar +/- 10% |
| Dimensiones | 310 x 460 mm |
| Peso | 3 Kg |



Descripción y usos: Los interruptores de presión están diseñados para arranque y parada automáticos de grupos de presión con bombas de superficie y de pozo profundo equipadas con motores eléctricos.



PC - 15 (AUTÓMATA BOMBA)

| | |
|------------------|-------------------------|
| Bomba monofásica | Protección paro en seco |
|------------------|-------------------------|

| | |
|----------|-----------|
| Potencia | 900 w |
| Puertos | 15,5 m |
| Caudal | 355 L/min |
| Peso | 0,5 Kg |



Descripción y usos: Los interruptores de presión están diseñados para arranque y parada automáticos de grupos de presión con bombas de superficie y de pozo profundo equipadas con motores eléctricos.



TUBO 50 CM

| | |
|--------------------|----------------|
| Temperatura máxima | 90° |
| Diámetro | ø 26mm - ø33mm |
| Peso | 0,35 Kg |





SGH 130

hidrolimpiadora

MOTOR INDUCCIÓN

| | | | | |
|------------|-----------------|----------------|---------|-------------------|
| Enrollador | 5 m de manguera | Boquilla turbo | Cepillo | Filtro de entrada |
|------------|-----------------|----------------|---------|-------------------|

| | |
|--------------|----------------------|
| Alimentación | Monofásica 230V-50Hz |
| Presión | 130 bar |
| Caudal | 390 L/H |
| Vel.giro | 2800 rpm |
| Potencia | 2500 W |
| Embalaje | 940 x 410 x 385 mm |
| Peso | 22 kg |



| REFERENCIA | DESCRIPCIÓN |
|---------------|---|
| SGH130NA12-13 | INTERRUPTOR |
| SGH130NA14 | CONDENSADOR |
| SGH130NA7-9 | ENROLLADOR |
| SGH130NA43 | MANGUERA ALTA PRESION |
| SGH130NA41 | LANZA |
| SGH130NA42 | PISTOLA |
| SGHAL | ALAMBRE LIMPIEZA BOQUILLAS |
| SGHCEPILLO | CEPILLO HIDROLIMPIADORA |
| SGHCONETPIS | RACORD PISTOLA SGH (M22X1.5INT15-3/8M) |
| SGHFILTRO | FILTRO ENTRADA GRANDE |
| SGHLANTUR | LANZA TURBO |

Descripción y usos: Su presión alcanza los 130 bares, así que tendrás una gran potencia para poder desincrustar todo tipo de suciedad: en baldosas, paredes, carrocería del coche, etc. Sus ruedas facilitan el movimiento para que puedas transportarla donde necesites y limpiar todas las zonas que quieras. Viene con la pistola a presión cepillo, boquillas y filtro.



SGH 150

MOTOR INDUCCIÓN

hidrolimpiadora

| | | | | |
|------------|-----------------|----------------|---------|-------------------|
| Enrollador | 5 m de manguera | Boquilla turbo | Cepillo | Filtro de entrada |
|------------|-----------------|----------------|---------|-------------------|

| | |
|--------------|----------------------|
| Alimentación | Monofásica 230V-50Hz |
| Presión | 150 bar |
| Caudal | 408 L/H |
| Vel.giro | 2800 rpm |
| Potencia | 3000 W |
| Embalaje | 940 x 410 x 385 mm |
| Peso | 24 kg |



| REFERENCIA | DESCRIPCIÓN |
|---------------|--|
| SGH130NA12-13 | INTERRUPTOR |
| SGH130NA14 | CONDENSADOR |
| SGH130NA7-9 | ENROLLADOR |
| SGH130NA43 | MANGUERA ALTA PRESION |
| SGH130NA41 | LANZA |
| SGH130NA42 | PISTOLA |
| SGHAL | ALAMBRE LIMPIEZA BOQUILLAS |
| SGHCEPILLO | CEPILLO HIDROLIMPIADORA |
| SGHCONETPIS | RACORD PISTOLA SGH (M22X1.5INT15-3/8M) |
| SGHFILTRO | FILTRO ENTRADA GRANDE |
| SGHLANTUR | LANZA TURBO |

Descripción y usos: Su presión alcanza los 150 bares, en sus estética es igual a la sgh 130. En cuanto a características técnicas tenemos mejores prestaciones. Sus ruedas facilitan el movimiento para que puedas transportarla donde necesites y limpiar todas las zonas que quieras. Viene con la pistola a presión cepillo, boquillas y filtro.



SGFD 152/9

hidrolimpiadora



| | | |
|----------------|-----------|--------------------------------|
| Chasis pintado | Agua fría | Lanza completa y manguera 10 m |
|----------------|-----------|--------------------------------|

| | |
|----------|--------------------|
| V50 Hz | 1-230V |
| Presión | 152 bar |
| Caudal | 540 L/h |
| Vel.giro | 1450 rpm |
| Potencia | 4 hp |
| Embalaje | 710 x 425 x 475 mm |
| Peso | 55 kg |

| REFERENCIA | DESCRIPCIÓN |
|----------------|------------------------------------|
| 00040B | BOQUILLA ACOPLAMIENTO RAPIDO 0° |
| 15040 | BOQUILLA ACOPLAMIENTO RAPIDO 15° |
| 25040 | BOQUILLA ACOPLAMIENTO RAPIDO 25° |
| 40040 | BOQUILLA ACOPLAMIENTO RAPIDO 40° |
| 60400 | BOQUILLA ACOPLAMIENTO RAPIDO JABON |
| DNBMP | BOQUILLA MULTIPOSICION |
| DNSBT | BOQUILLA TURBO 206/13 Y 152/9 |
| 1512C-23/24/25 | PISTON +BIELA 152/9 |
| 1512C-37 | VALVULA 152/9 |
| 1512C-39/38 | TAPON VALVULA+TORICA 152/9 |
| 3WZ1507A | BOMBA SGFD152/9 |

| | |
|-------------|------------------------------------|
| 1512C-27/34 | KIT REPARACION 152/9 |
| DNBP19 | FILTRO ENTRADA |
| DNLANZA1 | LANZA CON ENCHUFE RAPIDO BOQUILLA |
| DNBP30 | MANGUERA 10MTS |
| DNPISTOLA1 | PISTOLA + PROLONGACION CON ENCHUFE |

Descripción y usos: Maquina semiprofesional con chasis de acero pintado, incorpora 5 boquillas. Ideada para sector de automoción, agrícola, industria. Incorpora ruedas.



SGFD 206/13 INOX

hidrolimpiadora



| | | | | |
|----------------|-------------------------|-----------|--------------------------------|-------------|
| Chasis pintado | Detergente baja presión | Agua fría | Lanza completa y manguera 10 m | Capota inox |
|----------------|-------------------------|-----------|--------------------------------|-------------|

| | |
|----------|--------------------|
| V50 Hz | 3-400V |
| Presión | 200 bar |
| Caudal | 780 L/h |
| Vel.giro | 1450 rpm |
| Potencia | 7,5 hp |
| Embalaje | 850 x 490 x 540 mm |
| Peso | 79 kg |



| REFERENCIA | DESCRIPCIÓN |
|----------------|--|
| 1507A-23/24/25 | PISTON+BIELA 206/13 |
| 1507A-27/34 | KIT REPARACION 206/13 |
| 1507A-36 | TORICA VALVULA 206/13 |
| 1507A-37 | VALVULA 206/13 |
| 1507A-38/39 | TAPON VALVULA 206/13 |
| 3WZ1830-5T4 | BOMBA 206BAR/13L (MAQUINAS ELECTRICAS) |
| 00040B | BOQUILLA ACOPLAMIENTO RAPIDO 0° |
| 15040 | BOQUILLA ACOPLAMIENTO RAPIDO 15° |
| 25040 | BOQUILLA ACOPLAMIENTO RAPIDO 25° |
| 40040 | BOQUILLA ACOPLAMIENTO RAPIDO 40° |
| 60400 | BOQUILLA ACOPLAMIENTO RAPIDO JABON |

| | |
|------------|------------------------------------|
| DNBMP | BOQUILLA MULTIPOSICION |
| DNSBT | BOQUILLA TURBO 206/13 Y 152/9 |
| DNSP19 | FILTRO ENTRADA |
| DNLANZA1 | LANZA CON ENCHUFE RAPIDO BOQUILLA |
| DNSP30 | MANGUERA 10MTS |
| DNPISTOLA1 | PISTOLA + PROLONGACION CON ENCHUFE |

Descripción y usos: capota en chasis inox, potente hidrolimpiadora con 200 bares y 1450 rpm. Incluye ruedas para un fácil manejo y transporte. Equipada con lanza completa y manguera de 10 metros.



SGH 207/10

hidrolimpiadora



| | |
|----------------|-----------------|
| Chasis pintado | 8 m de manguera |
|----------------|-----------------|

| | |
|---------------------|--------------------|
| Motor | Gasolina 4T |
| Potencia | 5,5 kW - 7 hp |
| Presión | 207 bar |
| Caudal | 570 L/min |
| Depósito gasolina | 3,6 L |
| Depósito detergente | 2000 ml |
| Ruedas | 12 pulgadas |
| Embalaje | 583 x 430 x 530 mm |



| REFERENCIA | DESCRIPCIÓN |
|-------------|-------------------------------------|
| GT207/10-19 | RUEDA GT-207/10 |
| GT207/10-35 | PISTOLA CON LANZA GT-207/10 |
| LT-P15.1 | BOQUILLA ASPIRACION JABON GT-207/10 |
| LT-P15.2 | VALVULA RETORNO GT-207/10 |
| LT-P15-15 | RETEN DE ACEITE GT-207/10 |
| LTP201.1-3 | PISTON GT-207/10 |
| LTP201.2.1 | VALVULA GT-207/10 |
| LTP201.2-6 | TAPON VALVULAS GT-207/10 |
| LTP201.2-8 | VALVULA TERMICA GT-207/10 |
| LTP202.2.2 | VALVULA GT-207/10 |
| LTPH212H | BOMBA GT-207/10 |
| LT810.2-34 | MANGUERA ALTA PRESION |
| DNSBT | BOQUILLA TURBO 206/13 Y 152/9 |
| 00040B | BOQUILLA ACOPLAMIENTO RAPIDO 0° |

| | |
|----------------|------------------------------------|
| 15040 | BOQUILLA ACOPLAMIENTO RAPIDO 15° |
| 25040 | BOQUILLA ACOPLAMIENTO RAPIDO 25° |
| 40040 | BOQUILLA ACOPLAMIENTO RAPIDO 40° |
| 60400 | BOQUILLA ACOPLAMIENTO RAPIDO JABON |
| DNBMP | BOQUILLA MULTIPOSICION |
| 193490001-0001 | ARRANQUE COMPLETO |
| 270920171-0001 | BOBINA |
| 170020422-0001 | CARBURADOR |
| 180020323-0001 | FILTRO AIRE COMPLETO |

Descripción y usos: Máquina recomendada para uso doméstico. Incorpora 5 boquillas. **Boquilla rotativa OPCIONAL.** Referencia boquilla turbo DNSBT.



SGFD 247/17

hidrolimpiadora



| | | |
|----------------|-----------|-----------------------------------|
| Chasis pintado | Agua fría | Lanza completa y manguera de 10 m |
|----------------|-----------|-----------------------------------|

| | |
|----------|--------------------|
| Motor | Gasolina |
| Presión | 247 bar |
| Caudal | 20 L/min |
| Vel.giro | 3400 rpm |
| Potencia | 13 hp |
| Embalaje | 790 x 500 x 580 mm |
| Peso | 67 kg |



| REFERENCIA | DESCRIPCIÓN |
|----------------|----------------------------------|
| 1510A-23/24/25 | PISTON+BIELA 247/17 |
| 1510A-27/34 | KIT REPARACION 247/17 |
| 1510A-36 | TORICA VALVULA 247/17 |
| 1510A-37 | VALVULA 247/17 |
| 1510A-39/38 | TAPON VALVULA+TORICA 247/17 |
| 3WZ1510A | BOMBA 247BAR 17L/ MINUTO |
| SGFD247/17RUE | RUEDA PARA SGFD 247/17 |
| 00040B | BOQUILLA ACOPLAMIENTO RAPIDO 0° |
| 15040 | BOQUILLA ACOPLAMIENTO RAPIDO 15° |
| 25040 | BOQUILLA ACOPLAMIENTO RAPIDO 25° |
| 40040 | BOQUILLA ACOPLAMIENTO RAPIDO 40° |

| | |
|----------------|------------------------------------|
| 60400 | BOQUILLA ACOPLAMIENTO RAPIDO JABON |
| DNBMP | BOQUILLA MULTIPOSICION |
| DNSBT2 | BOQUILLA TURBO 247/17 |
| DNSP19 | FILTRO ENTRADA |
| DNLANZA1 | LANZA CON ENCHUFE RAPIDO BOQUILLA |
| DNSP30 | MANGUERA 10MTS |
| DNPISTOLA1 | PISTOLA + PROLONGACION CON ENCHUFE |
| 193500017-0002 | ARRANQUE |
| 170021121-0001 | CARBURADOR |
| 270920182-0001 | BOBINA |
| SG30051 | FILTRO DE AIRE |

Descripción y usos: maquina semiprofesional, chasis de acero robusto y pintado, incorpora boquilla rotativa y engancho para manguera. Lleva además conexiones de manguera rápida.

MOLINOS DE BIDON
DESGRANADORES
MOTOAZADAS
APEROS MOTOAZADAS
MOTOCULTORES
APEROS MOTOCULTORES
MINITRANSPORTERS

HUERTA





MBIDON 50 INOX

molino de grano

Incluye 3 cribas
ø2 ø4 ø6

| | |
|--------------|--------------------|
| Alimentación | 220V 50-60Hz |
| Potencia | 1,6 hp |
| Embalaje | 460 x 470 x 520 mm |
| Peso | 10 kg |



Descripción y usos: Viene equipado con tres cribas de molido de diferentes tamaños. 10 kg aproximadamente. Con bidón de 50 Lt de capacidad. Ideal para la molienda de cereales como maíz o trigo.



MBIDON 50

molino de grano

Incluye 3 cribas
ø2 ø4 ø6

| | |
|--------------|--------------------|
| Alimentación | 220V 50-60Hz |
| Potencia | 1,6 hp |
| Embalaje | 460 x 470 x 520 mm |
| Peso | 10 kg |



Descripción y usos: Viene equipado con tres cribas de molido de diferentes tamaños. 10 kg aproximadamente. Con bidón de 50 Lt de capacidad. Ideal para la molienda de cereales como maíz o trigo.

RECAMBIOS MBIDON



9042430- MOTOR MBIDON

Peso 2,218 kg



AI038- CUCHILLA MBIDON

Peso 0,06 kg



XSDZ-6C INTERRUPTOR MBIDON

Peso 0,085 kg



RECAMBIOS MBIDON

CRIBA MBIDON



Referencia 665061
Características Criba Ø 1mm



Referencia 665064
Características Criba Ø 6mm



Referencia 665062
Características Criba Ø 2mm



Referencia 665065
Características Criba Ø 8mm



Referencia 665063
Características Criba Ø 3mm





DESGRANADOR

desgranador

| | |
|--------------|---------------------|
| Alimentación | 220V-50Hz |
| Potencia | 1 hp |
| Producción | 200 kg/h |
| Embalaje | 800 x 750 x 1200 mm |
| Peso | 85 kg |



| REFERENCIA | DESCRIPCIÓN |
|------------|-----------------------------------|
| 21UCP204 | SOPORTES CX UCP - 204 |
| A TP12511 | POLEA SPA 125 (130) TP 1610 |
| A 161020 | TAPER 1610-20 |
| GY-A-35 | CORREA A-35 13X889/919 |
| MY802-4 | MOTOR 1HP 220V 50 HZ |
| A TP6311 | POLEA 63P SPA 1 TP 1008 |
| A 100819 | TAPER 1008-19 |
| R00520 | RUEDA 100X32-12.3 + CASQUI + TLLO |

Descripción y usos: Ideal para desgranar el maíz, fabricado en acero alta calidad para una larga duración.

DESGRANADOR

desgranador manual

| | |
|----------|--------------------|
| Embalaje | 130 x 140 x 170 mm |
| Peso | 4,5 kg |





MZ500S

motoazada

| | |
|-----------------|----------------------|
| Motor | Sport Garden |
| Potencia | 6,5 hp |
| Velocidad | 2 adelante / 1 atrás |
| Ancho fresa | 500 a 840 mm |
| Elementos fresa | 6 |
| Embalaje | 375 x 800 x 740 mm |
| Peso | 70 kg |



MZ500H

motoazada

| | |
|-----------------|----------------------|
| Motor | HONDA GX160 |
| Potencia | 5,5 hp |
| Velocidad | 2 adelante / 1 atrás |
| Ancho fresa | 500 a 840 mm |
| Elementos fresa | 6 |
| Embalaje | 375 x 800 x 740 mm |
| Peso | 70 kg |



| REFERENCIA | DESCRIPCIÓN |
|----------------------|---------------------------------|
| SG30030 | ARRANQUE COMPLETO |
| 270920171-0001 | BOBINA |
| 170020406-0001 | CARBURADOR |
| 180020323-0001 | FILTRO AIRE COMPLETO |
| T0301100 | RUEDA DELANTERA MZ500 |
| T0302400 | INTERRUPTOR DE PARO MZ500 |
| T0302500 | CABLE ACELERADOR MZ500 |
| T0302600 | MANDO ACELERADOR MZ500 |
| T0302900 | CABLE EMBRAGUE MZ500 |
| T0302901 | PALANCA EMBRAGUE MZ500 |
| T0303001 | TAPÓN ACEITE PEQUEÑO MZ500 |
| T0303002 | TAPÓN ACEITE GRANDE MZ500 |
| T0306006 | CORREA 17*914LI*963LW MZ500 |
| T0306016 | BARRA DE PROFUNDIDAD MZ500 |
| 02.T073.027.07700001 | CAJA TRANSMISION COMPLETA MZ500 |
| T0304100 | PLATO FRESA MZ500 |

Descripción y usos: ideal para preparar la superficie y el cultivo del huerto de hasta 1000 m² recomendados. Trabaja con 2 marchas delanteras y una trasera. Uso semiprofesional, preparar para incorporar aperos. Recomendada uso doméstico.



KIT COMPLETO MZ500S

Componentes Juego de ruedas
400x8", separadores
y arado



RECAMBIOS MOTOAZADA

T0304002

Descripción cuchilla derecha para fresa
Peso 0,206 kg

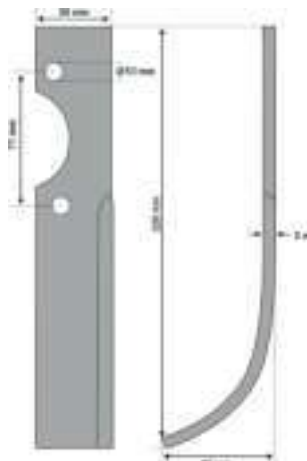

T0304003

Descripción cuchilla izquierda para fresa
Peso 0,206 kg

R-400.8

Descripción juego de ruedas 400x8"
Peso 4 kg / unidad



SEP RMZ500

Juego separadores ruedas (opción venta individual)

Peso 1,618 kg



110003 MZ500

Enganche asurcador largo

Peso 1,306 kg





MZ700S1

motoazada

| | |
|-----------------|----------------------|
| Motor | Sport Garden |
| Potencia | 7,0 hp |
| Velocidad | 3 adelante / 1 atrás |
| Ancho fresa | 800 a 1000 mm |
| Elementos fresa | 8 + disco lateral |
| Embalaje | 780 x 410 x 660 mm |
| Peso | 93 kg |



MZ700H

motoazada

| | |
|-----------------|----------------------|
| Motor | HONDA GX160 |
| Potencia | 5,5 hp |
| Velocidad | 3 adelante / 1 atrás |
| Ancho fresa | 800 a 1000 mm |
| Elementos fresa | 8 + disco lateral |
| Embalaje | 780 x 410 x 660 mm |
| Peso | 93 kg |

| REFERENCIA | DESCRIPCIÓN |
|------------------|---------------------------|
| HSD1G100.CA | CABLE EMBRAGUE MZ700S |
| SG400090 | DESPOSITO GASOLINA MZ700S |
| SG400083 | PALANCA DE CAMBIOS MZ700 |
| H170F | MOTOR MZ700 |
| CARBURADORH170F | CARBURADOR H170F |
| SG420001 | ARRANQUE COMPLETO H170F |
| SG400008 | RUEDA DELANTERA MZ700 |
| RECAMBIOS MZ700H | |
| SG401004 | EMBRAGUE COMPLETO MZ700S1 |
| SG401043 | MUELLE EMBRAGUE MZ700S1 |
| HSD1G100.CA | CABLE EMBRAGUE MZ700S |
| SG400083 | PALANCA DE CAMBIOS MZ700 |



Descripción y usos: ideal para preparar la superficie y el cultivo del huero hasta 2000 m2 recomendados. Uso semiprofesional, preparar para incorporar aperos.

RECAMBIOS MOTOAZADA



SG400012

Características Cuchilla derecha para fresa
Peso 0,336 kg

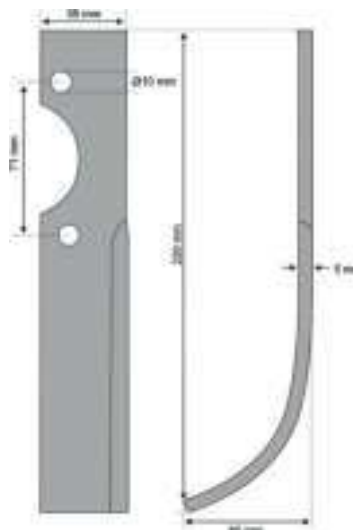

SG400011

Características Cuchilla izquierda para fresa
Peso 0,336 kg



R-500.10

juego de ruedas (opción venta individual)

Peso 8 kg unidad



APEROS MOTOAZADA



AS-1

| | |
|-----------------|-----------------|
| Características | arado asurcador |
| Peso | 4 kg |



M26B

juego ruedas hierro

| | |
|-----------------|-------------------------|
| Características | ø 32 cm/ 14 cm de ancho |
| Peso | 8 kg |



PT-1

arranca patatas

| | |
|--------------------|----------|
| Potencia requerida | 4-8 hp |
| Peso | 1,306 kg |



**NUEVO**

MTCMINIGASOLINA

Arranque manual

| | |
|------------------------------|----------------------|
| Motor | H210 |
| Potencia | 5,3 hp |
| Cap. Depósito de combustible | 3,6 L |
| Cap. Depósito de aceite | 0,6 L |
| Velocidades | -1 / 0 /1 |
| Velocidades cuchillas | 1 / 0 |
| Transmisión | Mediante engranajes. |
| Tamaño ruedas | 4.0 - 7 |
| Ancho de fresa | Máx. 580 mm |
| Profundidad de fresa | 100 - 300 mm |
| Peso | 86 Kg |
| Embalaje | 1170 x 460 x440 mm |



| REFERENCIA | DESCRIPCIÓN |
|------------------|-------------------------------|
| 20501-T07901 | EMBRAGUE |
| 20502-T07901 | CAMPANA EMBRAGUE |
| 10600-T07904-R01 | MANDO DE ACELERADOR CON CABLE |
| 30505-T03101 | INTERRUPTOR APAGADO |
| 10404-T11302 | CABLE EMBRAGUE |
| 25306-T11302-B01 | BARRA DE PROFUNDIDAD |
| 40102-T03101 | RUEDA |
| 40101-T03101 | CAMARA RUEDA |
| 40104-T03101-W01 | LLANTA PARTE EXTERIOR |
| 40103-T03101-W01 | LLANTA PARTE INTERIOR |
| 40301-T11301-B01 | SEPARADOR RUEDA |
| 50102-HW1502-B01 | SOPORTE AZADAS DOBLE |
| 50104-HW1502-BO1 | SOPORTE AZADAS SIMPLE |
| 50101-HW1501-B01 | AZADA IZQUIERDA |
| 50201-HW1501-B01 | AZADA DERECHA |
| H170F | MOTOR |
| CARBURADORH170F | CARBURADOR |
| SG400090 | DEPOSITO GASOLINA |



MTC DIESEL AE

motocultor

| | | |
|------------|--------------------|-------|
| Fresa fija | Arranque eléctrico | Luces |
|------------|--------------------|-------|

| | |
|---------------------|---------------------|
| Motor | Kama 168F e-starter |
| Potencia | 10 hp |
| Velocidad | 3-2 |
| Ancho de fresa | 63,5 cm |
| Rueda | 5 "X10" |
| Embalaje | 1140 x 700 x830 mm |
| Peso | 185 kg |
| Bloqueo diferencial | si |



| REFERENCIA | DESCRIPCIÓN |
|---------------|-------------------------------|
| 0400362700000 | EMBRAGUE |
| 0402762700000 | CAJA DE CAMBIOS |
| 0412561100000 | RUEDA |
| 0418161110200 | CABLE EMBRAGUE Y MARCHA ATRÁS |
| 0419161120000 | PALANCA MARCHA ATRÁS |
| 0413761110000 | CABLE ACELERADOR |
| 0410062710000 | CABLE EMBRAGUE |
| 0413661100000 | CABLE ACELERADOR COMP |
| 0415961160100 | PALANCA SEGURIDAD |
| 41256271000 | PALANCA INFERIOR |

EQUIPAMIENTO INCLUIDO



velocidad de cuchillas 290 rpm
anchura y profundidad ajustables



MTC LONCIN GASOLINA AE

motocultor

| | | |
|------------|--------------------|-------|
| Fresa fija | Arranque eléctrico | Luces |
|------------|--------------------|-------|

| | |
|---------------------|--------------------|
| Motor | Loncin |
| Potencia | 15 hp |
| Velocidad | 3-2 |
| Ancho de fresa | 63,5 cm |
| Rueda | 5 "X10" |
| Embalaje | 1140 x 700 x830 mm |
| Peso | 185 kg |
| Bloqueo diferencial | si |



| REFERENCIA | DESCRIPCIÓN |
|-------------|----------------------|
| G639XNN000 | CABLE |
| G339XYC0000 | CABLE TRACCION |
| G34AWY00000 | SOPORTE CUCHILLA |
| G623N000000 | TAPA CORREAS |
| G6510000000 | CUCHILLA 21" |
| G3520000000 | ARANDELA CUCHILLA |
| B1001B00032 | TORNILLO CUCHILLA |
| G54N1000000 | RUEDA 11" (TRASERA) |
| G34H3000000 | RUEDA 8" (DELANTERA) |
| B0014W00000 | RODAMIENTO RUEDA |
| G54AL000000 | PIÑÓN IZQ |
| G54AM000000 | PIÑÓN DCH |

| | |
|----------------|-------------------------|
| G34GT000000 | TRACCION |
| G19K1000000 | BOLSA TELA CESTO |
| 193490527-0003 | ARRANQUE COMPLETO |
| 170022364-0001 | CARBURADOR |
| 270920529-0001 | BOBINA |
| 270020277-0002 | PLATO MAGNETICO |
| 180130178-0001 | FILTRO DE AIRE COMPLETO |
| 170870156-0001 | TAPON GASOLINA |

EQUIPAMIENTO INCLUIDO



velocidad de cuchillas 290 rpm
anchura y profundidad ajustables

APEROS MOTOCULTOR



AVG MTC

Arado de vertedera giratorio

Compuesto por dos rejas de arado; uno colocado sobre el otro.



AV MTC

Arados de vertedera (inferior)

Convierte la capa superficial del suelo para enterrar césped, malezas y cultivos anteriores. Alternativa eficaz para abrir nuevos caminos cuando se instalan ruedas grandes y pesos de ruedas.

Versión giratoria disponible para arar con un solo surco y para arar con eficacia en pendientes



APEROS MOTOCULTOR



AR MTC

El aporcador regulable puede mover la tierra suelta a la altura y posición deseadas. para crear crestas y surcos en suelo previamente labrado



TRITURADORA MTC

tritadora

Incluye rodillo trasero de apoyo

Ancho 76,2 cm

Ruedas giratorias y retráctiles

Deflector frontal de apertura y cierre automático

Mango de control para ajustar la altura de corte 1/2 a 4"

24 piezas de cuchillas en forma de "Y" de oscilación vertical





BS MTC

Barra de siega motocultor

Caja de engranajes en baño de aceite de alta resistencia.

Cuchillas activas dobles con protección de cuchilla

Segadoras ancho **110 cm**

Ajuste de altura: patines ajustables

Articulación: de lado a lado para seguir el terreno

Ideal para trabajos cercanos, debajo de cercas, terraplenes empinados



ENGANCHE RÁPIDO MTC

Eganche rápido mtc



MB12N

Arado de varillas regulable





413096 1090231

APVDOB

Arranca patatas

Potencia requerida 4-8 HP
Embalaje 580 x 420 x 480 mm
Peso 4 kg



413096 1741508

CONTRAPESO 500-10 MTC 17

Peso 17 kg



413096 1741490

CONTRAPESO 500-10 MTC 34

Peso 34 kg



413096 1741510

ENGANCHE APERO MTC

Peso 34 kg





SG MINITRANSPORTER 300

minitransporter

| | |
|--------------------|----------------------|
| Motor | Loncin |
| Potencia | 6,5 hp |
| Velocidades | 3-1 |
| Medidas remolque | 907 x 600 x 204 mm |
| Capacidad de carga | 300 kg |
| Dimensiones | 1650 x 705 x 1010 mm |
| Embalaje | 1270 x 760 x 1000 mm |
| Peso | 178 kg |



| REFERENCIA | DESCRIPCIÓN |
|----------------|----------------------|
| 2080026 | CORREA |
| 5010827 | MANDO GIRO |
| 5010946 | CABLE GIRO |
| 5010077 | INTERRUPTOR APAGADO |
| 5010768 | MANDO SEGURIDAD |
| 5010295 | PALANCA ACELERADOR |
| 5010059 | CABLE ACELERADOR |
| 5030061 | CADENAS 180X60 |
| 5010171 | ZAPATAS FRENO |
| 193490001-0001 | ARRANQUE COMPLETO |
| 270920171-0001 | BOBINA |
| 170020422-0001 | CARBURADOR |
| 180020323-0001 | FILTRO AIRE COMPLETO |



Descripción y usos: Las carretillas a motor son cajas de transporte que mediante un motor de gasolina se desplazan incluso por terrenos malos gracias a sus ruedas de oruga. Ideal para transporte de leña, ladrillos, cascote, detritos etc. Puede con una carga de hasta 300 kg.



SG MINITRANSPORTER H 300

minitransporter

| | |
|--------------------|----------------------|
| Motor | HONDA GX |
| Potencia | 5,5 hp |
| Velocidades | 3-1 |
| Medidas remolque | 907 x 600 x 204 mm |
| Capacidad de carga | 300 kg |
| Dimensiones | 1650 x 705 x 1010 mm |
| Embalaje | 1270 x 760 x 1000 mm |
| Peso | 178 kg |

DISPONIBLE CON MOTOR HONDA GP



| REFERENCIA | DESCRIPCIÓN |
|----------------|----------------------|
| 2080026 | CORREA |
| 5010827 | MANDO GIRO |
| 5010946 | CABLE GIRO |
| 5010077 | INTERRUPTOR APAGADO |
| 5010768 | MANDO SEGURIDAD |
| 5010295 | PALANCA ACELERADOR |
| 5010059 | CABLE ACELERADOR |
| 5030061 | CADENAS 180X60 |
| 5010171 | ZAPATAS FRENO |
| 193490001-0001 | ARRANQUE COMPLETO |
| 270920171-0001 | BOBINA |
| 170020422-0001 | CARBURADOR |
| 180020323-0001 | FILTRO AIRE COMPLETO |



Descripción y usos: Las carretillas a motor son cajas de transporte que mediante un motor de gasolina se desplazan incluso por terrenos malos gracias a sus ruedas de oruga. Ideal para transporte de leña, ladrillos, cascote, detritos etc. Puede con una carga de hasta 300 kg.



SG MINITRANS 500

minitransporter

| | |
|---------------------|----------------------|
| Motor | Loncin |
| Potencia | 6,5 hp |
| Velocidades | 3-1 |
| Medidas remolque | 1100 x 650 x 350 mm |
| Capacidad de carga | 500 kg |
| Dimensiones totales | 1725 x 750 x 1010 mm |
| Embalaje | 1390 x 800 x 850 mm |
| Peso | 228 kg |



| REFERENCIA | DESCRIPCIÓN |
|----------------|----------------------------------|
| 5010059 | CABLE ACELERADOR |
| 5010295 | MANDO ACELERADOR |
| 5010077 | INTERRUPTOR ON/OFF |
| 5010827 | MANDOS GIRO |
| 2020012 | CABLE DIRECCIÓN (L. TOTAL 1.27M) |
| 5010567 | PALANCA CONTROL EMBRAGUE |
| 5010570 | CABLE EMBRAGUE |
| 2080026 | CORREA B32 |
| 5030068 | CADENA 180X60X38 |
| 193490001-0001 | ARRANQUE COMPLETO |
| 270920171-0001 | BOBINA |
| 170020422-0001 | CARBURADOR |
| 180020323-0001 | FILTRO AIRE COMPLETO |



Descripción y usos: Las carretillas a motor son cajas de transporte que mediante un motor de gasolina se desplazan incluso por terrenos malos gracias a sus ruedas de oruga. Ideal para transporte de leña, ladrillos, cascote, detritos etc. Puede con una carga de hasta 500 kg.



SG MINITRA 500 HONDA

minitransporter

| | |
|---------------------|----------------------|
| Motor | HONDA GX |
| Potencia | 6,5 hp |
| Velocidades | 3-1 |
| Medidas remolque | 1100 x 650 x 350 mm |
| Capacidad de carga | 500 kg |
| Dimensiones totales | 1725 x 750 x 1010 mm |
| Embalaje | 1390 x 800 x 850 mm |
| Peso | 228 kg |

DISPONIBLE CON MOTOR HONDA GP



| REFERENCIA | DESCRIPCIÓN |
|----------------|----------------------------------|
| 5010059 | CABLE ACELERADOR |
| 5010295 | MANDO ACELERADOR |
| 5010077 | INTERRUPTOR ON/OFF |
| 5010827 | MANDOS GIRO |
| 2020012 | CABLE DIRECCIÓN (L. TOTAL 1.27M) |
| 5010567 | PALANCA CONTROL EMBRAGUE |
| 5010570 | CABLE EMBRAGUE |
| 2080026 | CORREA B32 |
| 5030068 | CADENA 180X60X38 |
| 193490001-0001 | ARRANQUE COMPLETO |
| 270920171-0001 | BOBINA |
| 170020422-0001 | CARBURADOR |
| 180020323-0001 | FILTRO AIRE COMPLETO |

Descripción y usos: Las carretillas a motor son cajas de transporte que mediante un motor de gasolina se desplazan incluso por terrenos malos gracias a sus ruedas de oruga. Ideal para transporte de leña, ladrillos, cascote, detritos etc. Puede con una carga de hasta 500 kg.



SG MINITRANS 500 HID

remolque autobasculante hidráulico

| | |
|---------------------|----------------------|
| Motor | Loncin |
| Potencia | 6,5 hp |
| Velocidades | 3-1 |
| Medidas remolque | 1100 x 650 x 350 mm |
| Capacidad de carga | 500 kg |
| Dimensiones totales | 1725 x 750 x 1010 mm |
| Embalaje | 1390 x 800 x 850 mm |
| Peso | 228 kg |



| REFERENCIA | DESCRIPCIÓN |
|----------------|----------------------------------|
| 5010059 | CABLE ACELERADOR |
| 5010295 | MANDO ACELERADOR |
| 5010077 | INTERRUPTOR ON/OFF |
| 5010827 | MANDOS GIRO |
| 2020012 | CABLE DIRECCIÓN (L. TOTAL 1.27M) |
| 5010567 | PALANCA CONTROL EMBRAGUE |
| 5010570 | CABLE EMBRAGUE |
| 2080026 | CORREA B32 |
| 5030068 | CADENA 180X60X38 |
| 193490001-0001 | ARRANQUE COMPLETO |
| 270920171-0001 | BOBINA |
| 170020422-0001 | CARBURADOR |
| 180020323-0001 | FILTRO AIRE COMPLETO |



Descripción y usos: Las carretillas a motor son cajas de transporte que mediante un motor de gasolina se desplazan incluso por terrenos malos gracias a sus ruedas de oruga. Ideal para transporte de leña, ladrillos, cascote, detritos etc. Puede con una carga de hasta 500 kg.



SG MINIT 500 HID HON

remolque autobasculante hidráulico

| | |
|---------------------|----------------------|
| Motor | Honda GX |
| Potencia | 6,5 hp |
| Velocidades | 3-1 |
| Medidas remolque | 1100 x 650 x 350 mm |
| Capacidad de carga | 500 kg |
| Dimensiones totales | 1725 x 750 x 1010 mm |
| Embalaje | 1390 x 800 x 850 mm |
| Peso | 228 kg |



| REFERENCIA | DESCRIPCIÓN |
|----------------|----------------------------------|
| 5010059 | CABLE ACELERADOR |
| 5010295 | MANDO ACELERADOR |
| 5010077 | INTERRUPTOR ON/OFF |
| 5010827 | MANDOS GIRO |
| 2020012 | CABLE DIRECCIÓN (L. TOTAL 1.27M) |
| 5010567 | PALANCA CONTROL EMBRAGUE |
| 5010570 | CABLE EMBRAGUE |
| 2080026 | CORREA B32 |
| 5030068 | CADENA 180X60X38 |
| 193490001-0001 | ARRANQUE COMPLETO |
| 270920171-0001 | BOBINA |
| 170020422-0001 | CARBURADOR |
| 180020323-0001 | FILTRO AIRE COMPLETO |



Descripción y usos: Las carretillas a motor son cajas de transporte que mediante un motor de gasolina se desplazan incluso por terrenos malos gracias a sus ruedas de oruga. Ideal para transporte de leña, ladrillos, cascote, detritos etc. Puede con una carga de hasta 500 kg.



SG MINITRANS PALA

minitransporter

| | |
|------------------------|-------------------|
| Motor | Loncin |
| Potencia | 6,6 HP |
| Transmisión | Hidrostática |
| Capacidad de carga | 500 kg |
| Profundidad de la pala | 660 mm |
| Longitud de la pala | 1065 mm |
| Ancho de la pala | 715 mm |
| Ancho de las orugas | 180 mm |
| Embalaje | 1734 x 857 x 1224 |
| Peso | 360 kg |



| REFERENCIA | DESCRIPCIÓN |
|----------------|----------------------|
| 193490001-0001 | ARRANQUE COMPLETO |
| 270920171-0001 | BOBINA |
| 170020422-0001 | CARBURADOR |
| 180020323-0001 | FILTRO AIRE COMPLETO |



Descripción y usos: Las carretillas a motor son cajas de transporte que mediante un motor de gasolina se desplazan incluso por terrenos malos gracias a sus ruedas de oruga. Ideal para transporte de leña, ladrillos, cascote, detritos etc. Puede con una carga de hasta 500 kg.



Disfrute de las ventajas que le ofrecemos. Realice su pedido en cuestión de minutos

Solicite sus claves en ausavil o en nuestro mail mkt-tools@ausavil.com

LIMAS PARA CADENAS
AFILADORES DE CADENAS
CABALLETE PARA MOTOSIERRA
ROMPEDOR DE CADENA
REMACHADOR DE CADENA
CADENA MOTOSIERRA
ACEITES
DISCOS
CABEZALES
SISTEMAS DE PROTECCIÓN
NYLON
DEPÓSITOS

CONSUMIBLES



SG40000031364Q

limas para cadenas

| | |
|------------------|------------------|
| Características | 3/8 bp // Ø 4 mm |
| Formato de venta | Caja 12 unidades |
| Peso | 0,417 kg |



SG400000345Q

limas para cadenas

| | |
|------------------|------------------|
| Características | 325" // Ø 4,8 mm |
| Formato de venta | Caja 12 unidades |
| Peso | 0,339 kg |



SG4000003732Q

limas para cadenas

| | |
|------------------|------------------|
| Características | 3/8" // Ø 5,2 mm |
| Formato de venta | Caja 12 unidades |
| Peso | 0,447 kg |

Descripción y usos: Lima redonda de para afilar cadena de motosierra.



SG30501

mango lima



Descripción y usos: Fabricado con materiales de primera calidad, con las propiedades más adecuadas al trabajo a realizar. Ligero. Diseño ergonómico. Forma ovalada para mejorar la comodidad durante el trabajo, evitando el giro del mango. Gran comodidad de agarre, agradable al tacto y excelente sensación en la mano.



SG 220S

afilador de cadenas

Fabricado totalmente en acero cincado utilizable con otodo tipo de motosierras.

| | |
|----------|--------------------|
| Potencia | 220 W |
| Embalaje | 276 x 182 x 185 mm |
| Peso | 1,6 kg |



recambio disco afilador:
referencia: **sg220SA-52**



recambio disco diamante widea:
referencia: **sg31039**



recambio disco afilador:
referencia: **sg230SA-39**



SG 230SA

afilador de cadenas

Apta para todos los pases de cadena, incluye 1 disco de 145ø mm. Protector de disco

| | |
|----------|--------------------|
| Potencia | 220 W |
| Embalaje | 300 x 290 x 270 mm |
| Peso | 5,8 kg |



AU001464

caballete para motosierra

| | |
|----------|-------------------|
| Embalaje | 910 x 260 x 80 mm |
| Peso | 10,5 kg |



Descripción y usos: caballete universal en chasis de acero cincado, plegable, válido para todo tipo de motosierras. Garantiza un uso sin esfuerzo por parte del usuario.

CADENA DE MOTOSIERRA - ROLLOS**SG 3/8LP**

| | |
|-----------------|-----------------|
| Características | 3/8 bp 050" 1,3 |
| Diente | Redondo |
| Eslabones | 1640 |
| Medida rollo | 100 pies |
| Peso | 6 kg |

SG 325050 C

| | |
|-----------------|--------------|
| Características | 325 050" 1,3 |
| Diente | Cuadrado |
| Eslabones | 1840 |
| Medida rollo | 100 pies |
| Peso | 9,4 kg |

SG 325050

| | |
|-----------------|--------------|
| Características | 325 050" 1,3 |
| Diente | Redondo |
| Eslabones | 1680 |
| Medida rollo | 100 pies |
| Peso | 9,5 kg |

SG 325058 C

| | |
|-----------------|--------------|
| Características | 325 058" 1,5 |
| Diente | Cuadrado |
| Eslabones | 1840 |
| Medida rollo | 100 pies |
| Peso | 8,4 kg |

SG 325058

| | |
|-----------------|---------------|
| Características | 3/8 0,58" 1,5 |
| Diente | Redondo |
| Eslabones | 1840 |
| Medida rollo | 100 pies |
| Peso | 8,5 kg |

SG 3/8 C

| | |
|-----------------|---------------|
| Características | 3/8 0,58" 1,5 |
| Diente | Cuadrado |
| Eslabones | 1640 |
| Medida rollo | 100 pies |
| Peso | 11 kg |

SG 3/8

| | |
|-----------------|---------------|
| Características | 3/8 0,58" 1,5 |
| Diente | Redondo |
| Eslabones | 1640 |
| Medida rollo | 100 pies |
| Peso | 10 kg |

SG 3/8063

| | |
|-----------------|---------------|
| Características | 3/8 0,63" 1,6 |
| Diente | Redondo |
| Eslabones | 1640 |
| Medida rollo | 100 pies |
| Peso | 10 kg |

SG 325063

| | |
|-----------------|---------------|
| Características | 325 0,63" 1,6 |
| Diente | Redondo |
| Eslabones | 1640 |
| Medida rollo | 100 pies |
| Peso | 10 kg |

REMACHES CADENA

| | | |
|---------|-----------|--------------|
| SG31044 | 3/8LP 050 | Bolsa 25 uds |
| SG31045 | 3/8 058 | Bolsa 25 uds |
| SG31046 | 325 050 | Bolsa 25 uds |
| SG31047 | 325 058 | Bolsa 25 uds |



CADENA DE MOTOSIERRA- ROLLOS



SG 3/8 LP 043 WIDEA

rollo de cadena

| | |
|-----------------|--------------|
| Características | 3/8 043" 1,1 |
| Eslabones | 410 |
| Medida rollo | 25 pies |



SG 325050 WIDEA

rollo de cadena

| | |
|-----------------|--------------|
| Características | 325 050" 1,3 |
| Eslabones | 460 |
| Medida rollo | 25 pies |



SG 3/8 LP WIDEA

rollo de cadena

| | |
|-----------------|--------------|
| Características | 3/8 050" 1,3 |
| Eslabones | 410 |
| Medida rollo | 25 pies |



SG 325058 WIDEA

rollo de cadena

| | |
|-----------------|--------------|
| Características | 325 058" 1,5 |
| Eslabones | 460 |
| Medida rollo | 25 pies |



SG 3/8 058 WIDEA

rollo de cadena

| | |
|-----------------|--------------|
| Características | 3/8 058" 1,5 |
| Eslabones | 410 |
| Medida rollo | 25 pies |

REMACHES CADENA

| | | |
|---------|-----------------|--------------|
| SG31040 | 3/8LP 050 WIDEA | Bolsa 25 uds |
| SG31041 | 325 050 WIDEA | Bolsa 25 uds |
| SG31042 | 325 058 WIDEA | Bolsa 25 uds |
| SG31043 | 325 058 WIDEA | Bolsa 25 uds |



CADENA DE MOTOSIERRA- BLISTER



REF.

CARACTERÍSTICAS

| | | |
|-------------------|--------------------------------|--|
| SG.CM.3/8.BP.45E | 3/8 Bajo perfil, 45 eslabones. | |
| SG.CM.3/8.BP.50E | 3/8 Bajo perfil, 50 eslabones. | |
| SG.CM.3/8.BP.52E | 3/8 Bajo perfil, 52 eslabones. | |
| SG.CM.3/8.BP.55E | 3/8 Bajo perfil, 55 eslabones. | |
| SG.CM.3/8.BP.56E | 3/8 Bajo perfil, 56 eslabones. | |
| SG.CM.3/8.BP.57E | 3/8 Bajo perfil, 57 eslabones. | |
| SG.CM.3/8.BP.60E | 3/8 Bajo perfil, 60 eslabones. | |
| SG.CM.3/8.BP.62E | 3/8 Bajo perfil, 62 eslabones. | |
| SG.CM.3/8.BP.72E | 3/8 Bajo perfil, 72 eslabones. | |
| SG.CM.325.050.56E | 325 050", 56 eslabones. | |
| SG.CM.325.050.64E | 325 050", 64 eslabones. | |
| SG.CM.325.050.66E | 325 050", 66 eslabones. | |
| SG.CM.325.050.72E | 325 050", 72 eslabones. | |
| SG.CM.325.050.78E | 325 050", 78 eslabones. | |
| SG.CM.325.058.56E | 325 058, 56 eslabones. | |
| SG.CM.325.058.64E | 325 058, 64 eslabones. | |
| SG.CM.325.058.66E | 325 058, 66 eslabones. | |
| SG.CM.325.058.68E | 325 058, 68 eslabones. | |
| SG.CM.325.058.72E | 325 058, 72 eslabones. | |
| SG.CM.325.058.78E | 325 058, 78 eslabones. | |
| SG.CM.3/8.058.56E | 3/8 0,58, 56 eslabones. | |
| SG.CM.3/8.058.64E | 3/8 0,58, 64 eslabones. | |
| SG.CM.3/8.058.66E | 3/8 0,58, 66 eslabones. | |
| SG.CM.3/8.058.68E | 3/8 0,58, 68 eslabones. | |
| SG.CM.3/8.058.72E | 3/8 0,58, 72 eslabones. | |
| SG.CM.3/8.058.76E | 3/8 0,58, 76 eslabones. | |



SG BR001

rompedor de cadena



Descripción y usos: rompecadena de banco. Desmontaje rápido y fácil de la cadena. Kit completo que incluye punzón ajustable. Válido para todo tipo de paso y tipo de cadenas más comunes.

recambios:

105530 YUNQUE ROMPEDOR CADENA

105531 YUNQUE AJUSTABLE ROMPEDOR CADENA

38594 PUNZON ROMPEDORA CADENA



SG SP001

remachador de cadena



Descripción y usos: fácil manejo, ideada para ensamblar las cadenas con precisión.

recambios:

SG SP001-CA CABEZA 1/4-325 REMACHADORA

SG SP001-CB CABEZA 3/8-404-7/16 REMACHADORA



SG GRASA

grasa

| | |
|------------------|--------------------------|
| Características | Grasa cabezal |
| Formato de venta | bote 150 gr/ 55 por caja |
| Peso | 0,123 kg |



Descripción y usos: Tubo ergonómico de grasa de alta calidad para todo tipo de engranajes. Válido para desbrozadoras.



SG 2T.OIL 125

aceite sintético

| | |
|------------------|-----------------------|
| Características | aceite sintético |
| Formato de venta | 125 ml / 100 por caja |
| Peso | 0,123 kg |



Descripción y usos: Aceite sintético alta calidad para la mezcla de motores de dos tiempos.



SG 2T SINTÉTICO 1L

aceite sintético 2T

| | |
|------------------|---------------------|
| Características | aceite sintético 2T |
| Formato de venta | 1L/ 20 por caja |
| Peso | 0,991 kg |



Descripción y usos: Aceite sintético alta calidad para la mezcla de motores de dos tiempos.



SG 2T OIL 1D

aceite sintético 2T

| | |
|------------------|--|
| Características | aceite sintético 2T/ c/ dosificador |
| Formato de venta | 1L/ 12 por caja |
| Peso | 0,991 kg |



Descripción y usos: aceite sintético alta calidad para la mezcla de motores de dos tiempos. Incorpora dosificador para su correcta mezcla.



SG 2T OIL 5L

aceite 2T

| | |
|------------------|-----------------|
| Características | Aceite 2T |
| Formato de venta | 5L / 4 por caja |
| Peso | 4,5 kg |



Descripción y usos: aceite sintético alta calidad para la mezcla de motores de dos tiempos.



SG 4T SINTÉTICO 1L

aceite 4T

| | |
|------------------|-------------------------------|
| Características | Aceite sintético 4T SAE 15W40 |
| Formato de venta | 1L / 20 por caja |
| Peso | 0,991 kg |



Descripción y usos: aceite sintético alta calidad para la mezcla de motores de cuatro tiempos.



SG 4T.OIL 5

aceite 4T

| | |
|------------------|---------------------|
| Características | Aceite sintético 4T |
| Formato de venta | 5L / 4 por caja |
| Peso | 4,5 kg |



Descripción y usos: aceite sintético alta calidad para la mezcla de motores de cuatro tiempos.



SG CS.OIL 5

aceite multiusos

| | |
|------------------|---------------------------|
| Características | Aceite engrase motosierra |
| Formato de venta | 5L / 4 por caja |
| Peso | 4,5 kg |



Descripción y usos: aceite especial para engrase de cadena de motosierra



Disco 2 puntas - Matorrales



6522/A

| | |
|--------------|----------|
| Ø Exterior | 250 |
| ø Interior | 25,4 |
| Espesor (mm) | 1,6 |
| Peso | 0,273 kg |



6530/A

| | |
|--------------|----------|
| Ø Exterior | 350 |
| ø Interior | 25,4 |
| Espesor (mm) | 1,2 |
| Peso | 0,280 kg |



6526/A

| | |
|--------------|----------|
| Ø Exterior | 350 |
| ø Interior | 25,4 |
| Espesor (mm) | 4 |
| Peso | 0,851 kg |



Disco 2 puntas curvados- Hierba resistente, zarzas y matorrales



6528E

| | |
|--------------|----------|
| Ø Exterior | 300 |
| ø Interior | 20 |
| Espesor (mm) | 3 |
| Peso | 0,560 kg |



6527E

| | |
|--------------|----------|
| Ø Exterior | 300 |
| ø Interior | 25,4 |
| Espesor (mm) | 3 |
| Peso | 0,520 kg |



6528

| | |
|--------------|----------|
| Ø Exterior | 300 |
| ø Interior | 20 |
| Espesor (mm) | 4 |
| Peso | 0,560 kg |



6527

| | |
|--------------|----------|
| Ø Exterior | 300 |
| ø Interior | 25,4 |
| Espesor (mm) | 4 |
| Peso | 0,560 kg |



Discos de triturar de 2 puntas curvado - Hierba resistente, zarzas y matorrales



6520E/A

| | |
|--------------|----------|
| Ø Exterior | 300 |
| ø Interior | 20 |
| Espesor (mm) | 3 |
| Peso | 0,560 kg |



6521E/A

| | |
|--------------|----------|
| Ø Exterior | 300 |
| ø Interior | 25,4 |
| Espesor (mm) | 3 |
| Peso | 0,520 kg |



6520/A

| | |
|--------------|----------|
| Ø Exterior | 300 |
| ø Interior | 20 |
| Espesor (mm) | 4 |
| Peso | 0,560 kg |



6521/A

| | |
|--------------|----------|
| Ø Exterior | 300 |
| ø Interior | 25,4 |
| Espesor (mm) | 4 |
| Peso | 0,560 kg |



Disco 2 puntas curvado - Hierba resistentes zarzas y matorrales

**6525/A****6524/A****6523/A****6529/A****6044****6059**

| | | | | | | |
|--------------|----------|----------|----------|-------|----------|----------|
| Ø Exterior | 300 | 300 | 300 | 300 | 205 | 250 |
| ø Interior | 25,4 | 20 | 20 | 25,4 | 25,4 | 25,4 |
| Espesor (mm) | 3 | 3 | 4 | 4 | 3 | 3 |
| Peso | 0,520 kg | 0,520 kg | 0,560 kg | 0,560 | 0,376 kg | 0,386 kg |



Disco 3 puntas recto - Hierba resistentes zarzas y matorrales

**6001E/A****6501E/A****6013E/A**

| | | | |
|--------------|----------|----------|----------|
| Ø Exterior | 255 | 300 | 300 |
| ø Interior | 25,4 | 20 | 25,4 |
| Espesor (mm) | 2,5 | 2,2 | 2,2 |
| Peso | 0,360 kg | 0,428 kg | 0,560 kg |

**6001/A****6501/A****6013/A****6002/A**

| | | | | |
|--------------|----------|----------|----------|----------|
| Ø Exterior | 255 | 300 | 300 | 300 |
| ø Interior | 25,4 | 20 | 25,4 | 20 |
| Espesor (mm) | 3 | 3 | 3 | 4 |
| Peso | 0,560 kg | 0,560 kg | 0,560 kg | 0,560 kg |



Disco 3 puntas curvado - Hierba resistentes zarzas y matorrales



6004E/A



6003E/A



6003/A



6004/A

| | | | | |
|--------------|----------|----------|----------|----------|
| Ø Exterior | 300 | 300 | 300 | 300 |
| ø Interior | 20 | 25,4 | 25,4 | 20 |
| Espesor (mm) | 3 | 3 | 4 | 4 |
| Peso | 0,880 kg | 0,880 kg | 0,880 kg | 0,880 kg |



Disco 8 puntas curvado - Hierba resistentes zarzas y matorrales



6504



6507

| | | |
|--------------|----------|----------|
| Ø Exterior | 255 | 255 |
| ø Interior | 20 | 25,4 |
| Espesor (mm) | 1,8 | 1,8 |
| Peso | 0,720 kg | 0,611 kg |

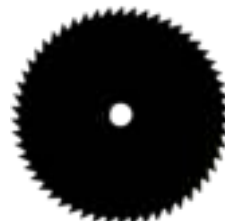

6038



6039

Disco 54 dientes - Arbustos fuertes y troncos delgados

| | | |
|--------------|----------|----------|
| Ø Exterior | 255 | 255 |
| ø Interior | 20 | 25,4 |
| Espesor (mm) | 1,8 | 1,8 |
| Peso | 0,720 kg | 0,611 kg |

DISCOS OEM



Disco 3 puntas plano- Maleza densa, hierba resistente y zarzas



60020EM

| | |
|--------------|----------|
| Ø Exterior | 350 |
| ø Interior | 20 |
| Espesor (mm) | 4 |
| Peso | 0,520 kg |



60040EM

| | |
|--------------|----------|
| Ø Exterior | 350 |
| ø Interior | 25,4 |
| Espesor (mm) | 4 |
| Peso | 0,520 kg |



Disco 3 puntas plano - Maleza densa, hierba resistente y zarzas



65010EM

| | |
|--------------|----------|
| Ø Exterior | 300 |
| ø Interior | 20 |
| Espesor (mm) | 3 |
| Peso | 0,560 kg |



60130EM

| | |
|--------------|----------|
| Ø Exterior | 300 |
| ø Interior | 25,4 |
| Espesor (mm) | 3 |
| Peso | 0,520 kg |



60420EM

| | |
|--------------|-------|
| Ø Exterior | 300 |
| ø Interior | 20 |
| Espesor (mm) | 4 |
| Peso | 0,520 |



60480EM

| | |
|--------------|-------|
| Ø Exterior | 300 |
| ø Interior | 25,4 |
| Espesor (mm) | 4 |
| Peso | 0,520 |



Disco 2 puntas s shape curvados - hierba resistente, zarzas y matorrales



61940EM

| | |
|--------------|-----|
| Ø Exterior | 320 |
| ø Interior | 20 |
| Espesor (mm) | 3 |
| Peso | |



61950EM

| | |
|--------------|------|
| Ø Exterior | 320 |
| ø Interior | 25,4 |
| Espesor (mm) | 3 |
| Peso | |



65210EM

| | |
|--------------|----------|
| Ø Exterior | 320 |
| ø Interior | 25,4 |
| Espesor (mm) | 4 |
| Peso | 0,500 kg |



65200EM

| | |
|--------------|----------|
| Ø Exterior | 320 |
| ø Interior | 20 |
| Espesor (mm) | 4 |
| Peso | 0,500 kg |



Disco 2 puntas curvados - hierba resistente, zarzas y matorrales



65240EM



65250EM



65230EM



65220EM

| | | | | |
|--------------|----------|----------|----------|----------|
| Ø Exterior | 300 | 300 | 300 | 300 |
| ø Interior | 20 | 25,4 | 20 | 25,4 |
| Espesor (mm) | 3 | 3 | 4 | 4 |
| Peso | 0,520 kg | 0,520 kg | 0,520 kg | 0,520 kg |



Disco 2 puntas-



60810EM



60820EM

| | | |
|--------------|-----------------|-----------------|
| Ø Exterior | 300 | 300 |
| ø Interior | 20 | 25,4 |
| Espesor (mm) | 3 | 3 |
| Peso | 0,500 kg | 0,500 kg |



Disco 20 dientes widia- arbustos con troncos y nudos delgados



2520



2525



2520/A



2525/A

| | | | | |
|------------|----------|----------|----------|----------|
| Ø Exterior | 250 | 250 | 250 | 250 |
| ø Interior | 20 | 25,4 | 20 | 25,4 |
| Espesor | 1,8 | 1,8 | 1,8 | 1,8 |
| Peso | 0,724 kg | 0,724 kg | 0,760 kg | 0,760 kg |



Disco 24 dientes widia- arbustos con nudos y troncos delgados



2420/A

| | |
|------------|----------|
| Ø Exterior | 250 |
| ø Interior | 20 |
| Espesor | 1,5 |
| Peso | 0,614 kg |



2425/A

| | |
|------------|----------|
| Ø Exterior | 250 |
| ø Interior | 25,4 |
| Espesor | 1,5 |
| Peso | 0,614 kg |



Disco 24 dientes widia- arbustos con nudos y troncos delgados



3620 255/A

| | |
|------------|----------|
| Ø Exterior | 255 |
| ø Interior | 20 |
| Espesor | 1,5 |
| Peso | 0,566 kg |



3625 255/A

| | |
|------------|----------|
| Ø Exterior | 255 |
| ø Interior | 25,4 |
| Espesor | 1,5 |
| Peso | 0,566 kg |



Disco 40 dientes widia- arbustos con nudos y troncos delgados



40255 20/A

| | |
|--------------|----------|
| Ø Exterior | 255 |
| ø Interior | 20 |
| Espesor (mm) | 1,5 |
| Peso | 0,600 kg |



40255 25/A

| | |
|------------|----------|
| Ø Exterior | 255 |
| ø Interior | 25,4 |
| Espesor | 1,5 |
| Peso | 0,600 kg |



Cepillo de alambres

SG CEPILLO Ø200

Ø Exterior

200





GH02 1006

| | |
|-----------------|----------|
| Características | Aluminio |
| Nº Hilos | 4 |
| Peso | 0,579 kg |



GH02 1007- SPEED MONTAJE C/GIRO IZQ

| | |
|-----------------|-------------------|
| Características | Cabezal universal |
| Nº Hilos | 8 |
| Peso | 0,713 kg |



Recambios cabezal speed



PD001

| | |
|-----------------|-----------------------------|
| Características | Cono refuerzo inf. plástico |
|-----------------|-----------------------------|



PD004

| |
|---------------------------------------|
| Kit de recambio 2 dientes + 2 muelles |
|---------------------------------------|



SG30011

| |
|-------------------------|
| Kit arandelas reducción |
|-------------------------|



GH02 20056

| | |
|-----------------|-------------------|
| Características | Cabezal universal |
| Nº Hilos | 8 |
| Peso | 0,263 kg |

recambio tornillo interior cabezal aluminio
referencia: **252110020**



GH02 20056 TL

| | |
|-----------------|---------------------------------------|
| Características | Cabezal universal c/ tornillo lateral |
| Nº Hilos | 8 |
| Peso | 0,263 kg |

recambio tornillo interior cabezal aluminio
referencia: **184210025**



GH02 20001

| | |
|-----------------|-------------------|
| Características | Cabezal universal |
| Nº Hilos | 8 |
| Peso | 0,375 kg |





GH02 20050

| | |
|-----------------|-------------------|
| Características | Cabezal universal |
| Nº Hilos | 12 |
| Peso | 0,469 kg |



GH02 20060

| | |
|-----------------|-------------------|
| Características | Cabezal universal |
| Nº Hilos | 4 |



GH02 2240

| | |
|-----------------|---|
| Características | Carga semiautomática |
| Nº Hilos | 2 |
| Adaptadores | 8 x 125 mm 10 x 125 mm 10 x 150 mm 12 x 175 mm |
| Diámetro | 14,40 x 6,70 cm |
| Peso | 504 gr |

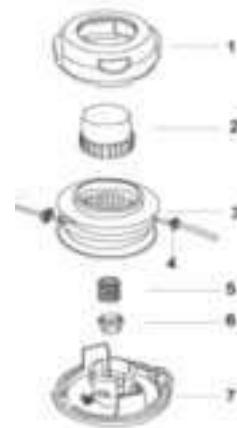

50719296 50719297 50719298 50719299 50719200 50719110

| | | | | | | |
|-----------------|--------------------------|--------------|----------------|-----------------|---------------|----------------------|
| Características | Cubierta superior | Botón | Carrete | Ovalillo | Muelle | Tapa inferior |
|-----------------|--------------------------|--------------|----------------|-----------------|---------------|----------------------|



GH02 3209

| | |
|-----------------|--------------------------------|
| Características | Carga automática |
| Nº Hilos | 2 |
| Adaptadores | 10 x 100 mm 10 x 125 mm / w |
| Diámetro | 14,40 x 6,70 cm |
| Peso | 504 gr |

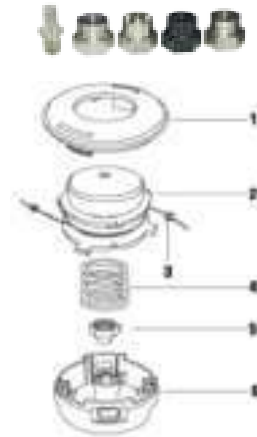

Características

| | | | | |
|-------------------|----------------|----------------|----------------|----------------|
| 5073901 | 5073902 | 5073903 | 5073904 | 5073908 |
| Cubierta superior | Carrete | Ovalillo | Muelle | Tapa inferior |



GH02 2239

| | |
|-----------------|--|
| Características | Cabezal automático rosca izq. |
| | Hm 10 x 1,25 |
| Diámetros | Ø 100,35 mm Ø int. ovalillo 5,07 mm |
| N hilos | 2 |
| Peso | 0,250 kg |



GH02 1201

| | |
|-----------------|-------------------------------------|
| Características | Cabezal automático |
| | Rosca izq. H.M 10 x 1,25 |
| Diámetros | Ø 110 mm Ø int. ovalillo 5,25 mm |
| N hilos | 2 |
| Peso | 0,240 kg |





GH02 10125

| | |
|-----------------|---|
| Características | Cabezal semi-automático carga rápida con adaptadores |
| Diámetros | Ø 138 mm Ø int. ovalillo 6,1 mm |
| N hilos | 2 |
| Peso | 0,500 kg |



ADAPTADORES OPCIONALES

SG30505 Macho rosca izq. M10x125



SG30507 Hembra rosca izq. M8x125



SG30506 Macho rosca izq. M10x125



SG30508 Hembra rosca izq. M12x150



Recambios GH02 10125

| | | | | | |
|-----------------|--------------------|---------------------|----------------|----------------|----------------------|
| | 10125-1 | 10125-2 | 10125-3 | 10125-4 | 10125-5 |
| Características | Tapa. sup (nº1) | Botón inf. (nº2) | Ovalillo (nº3) | Muelle (nº4) | Adaptador M (nº5) |

Modelo nº1

Modelo nº2

Modelo nº3

Modelo nº4

Modelo nº5







JDSH-01

| | |
|-----------------|--|
| Características | Arnes semi-profesional Cintos de polipropileno Hombreras de PVC Altura de colocación regulable Enganches rápidos de hierro |
| Peso | 0,950 kg |



CP H2628W

| | |
|-----------------|---|
| Características | Arnes profesional Cintos de polipropileno Hombreras de PVC, algodón y FOAM en el interior. Altura de colocación regulable Enganches rápidos de hierro |
| Peso | 0,435 kg |



ERGO ARNES EC

| | |
|-----------------|--|
| Características | Cintos de polipropileno Hombreras de EPE Altura de colocación regulable Enganches rápidos de hierro |
| Peso | 0,545 kg |





ERGO ARNES

| | |
|-----------------|--|
| Características | Cintos de polipropileno Hombreras de EPE Altura de colocación regulable Enganches rápidos de hierro |
| Peso | 0,850 kg |



CS 40043

| | |
|-----------------|---|
| Características | Equi.interior c/ 4 puntos Ventilación y ajuste posterior Perfecta visibilidad y comodidad |
| Peso | 0,670 kg |



PC 20073

| | |
|-----------------|---|
| Características | Pantalla de rejilla metálica con frontal abatible con interior de goma Altura de pantalla 210 mm |
| Peso | 0,127 kg |





PC 453 319

Características

Pantalla de plástico

Utilizable sin casco

Peso

0,144 kg



GT 20077

Características

Pantalla de rejilla metálica

Frontal abatible con interior de goma

Altura de pantalla 210 mm

Peso

0,254 kg



PC 20077

Características

Portavisera profesional

Pantalla de rejilla metálica

Frontal abatible

Regulación de profundidad y altura

Con parasudor frontal

Peso

0,670 kg



Guante de protección contra riesgos mecánicos y riesgo motosierra clase 1 20 m/s

Cuero sintético negro con refuerzo acolchado de EVA con canal de cuerda en la palma.

Parte trasera de tela naranja VIH con cuero negro sintético.

Materiales de protección dentro del guante izquierdo, brazaletes elásticos negro con velcro en la parte posterior ACOLCHADO DE EVA



GUANTE ANTICOR 21 M GUANTE ANTICOR 21 L GUANTE ANTICOR 21 XL

Talla

M

L

XL





PO 453 321

| | |
|-----------------|---|
| Características | Protector de oídos Utilizable sin cascos |
| Peso | 0,670 kg |



SG KNEP

| | |
|-----------------|--|
| Características | Juego de espinilleras de protección Trabajos de motosierra y máquinas de corte Talla única |
| Peso | 0,407 kg |



SG 6411

| | |
|-----------------|---|
| Características | Zahón para desbrozadora Protección especial anti-piedras |
| Tallas | L / XL |
| Peso | 0,670 kg |



SG 6420 (CLASE 2)

| | |
|-----------------|--|
| Características | Zahón anti-corte para motosierra Ajustable en cintura y piernas Anti-manchas y anti-agua |
| Tallas | L / XL |
| Peso | 0,127 kg |





SPORT GARDEN

Powered by
Kawasaki

1



2



3

**NYLON REDONDO**

1

| REF. | F. VENTA | ØNYLON | LARGO | PESO |
|--------|----------|--------|--------|----------|
| R1315 | 10 Uds. | 1,3 mm | 15 m | 0,04 kg |
| R1615 | 10 Uds. | 1,6 mm | 15 m | 0,06 kg |
| R2015 | 10 Uds. | 2,0 mm | 15 m | 0,08 kg |
| R2050 | 10 Uds. | 2,0 mm | 50 m | 0,240 kg |
| R2415 | 10 Uds. | 2,4 mm | 15 m | 0,100 kg |
| R2450 | 10 Uds. | 2,4 mm | 50 m | 0,320 kg |
| R24100 | 10 Uds. | 2,4 mm | 100 m | 0,850 kg |
| R3015 | 10 Uds. | 3,0 mm | 15 m | 0,160 kg |
| R3050 | 10 Uds. | 3,0 mm | 50 m | 0,490 kg |
| R3150 | 8 Uds. | 3,0 mm | 150 m | 1,69 kg |
| R3090 | 1 Ud. | 3,0 mm | 1.100m | 11,50 kg |
| R3315 | 10 Uds. | 3,3 mm | 15 m | 0,200 kg |
| R3330 | 10 Uds. | 3,3 mm | 30 m | 0,380 kg |
| R33150 | 8 Uds. | 3,3 mm | 150 m | 2,04 kg |
| R4015 | 10 Uds. | 4,0 mm | 15 m | 0,270 kg |
| R4030 | 10 Uds. | 4,0 mm | 30 m | 0,520 kg |

**NYLON ALUMINIO REDONDO**

2

| REF. | F. VENTA | ØNYLON | LARGO | PESO |
|--------|----------|--------|-------|---------|
| RA3056 | 10 Uds. | 3,0 mm | 56 m | 0,660kg |
| RA3346 | 10 Uds. | 3,3 mm | 46 m | 0,660kg |
| RA4032 | 10 Uds. | 4,0 mm | 32 m | 0,660kg |

**TUBO NYLON REDONDO**

3

| REF. | F. VENTA | ØNYLON | LARGO | PESO |
|--------|----------|--------|-----------|---------|
| TR3040 | 1 Ud. | 3,0 mm | 50udx40cm | 0,140kg |
| TR3340 | 1 Ud. | 3,3 mm | 50udx40cm | 0,140kg |





NYLON CUADRADO 1

| REF. | F. VENTA | ØNYLON | LARGO | PESO |
|--------|----------|--------|-------|----------|
| C1315 | 10 Uds. | 1,3 mm | 15 m | 0,046 kg |
| C1615 | 10 Uds. | 1,6 mm | 15 m | 0,062 kg |
| C2015 | 10 Uds. | 2,0 mm | 15 m | 0,090 kg |
| C2050 | 10 Uds. | 2,0 mm | 50 m | 0,250 kg |
| C2415 | 10 Uds. | 2,4 mm | 15 m | 0,120 kg |
| C2450 | 10 Uds. | 2,4 mm | 50 m | 0,350 kg |
| C24100 | 10 Uds. | 2,4 mm | 100 m | 0,750 kg |
| C3015 | 10 Uds. | 3,0 mm | 15 m | 0,170 kg |
| C3050 | 10 Uds. | 3,0 mm | 50 m | 0,530 kg |
| C3150 | 8 Uds. | 3,0 mm | 150 m | 1,900 kg |
| C3330 | 10 Uds. | 3,3 mm | 30 m | 0,410 kg |
| C4015 | 10 Uds. | 4,0 mm | 15 m | 0,270 kg |
| C4030 | 10 Uds. | 4,0 mm | 30 m | 0,560 kg |
| C4140 | 4 Uds. | 4,0 mm | 140 m | 2,7 kg |



NYLON ALUMINIO CUADRADO 2

| REF. | F. VENTA | ØNYLON | LARGO | PESO |
|--------|----------|--------|-------|----------|
| CA3051 | 10 Uds. | 3,0 mm | 51 m | 0,660 kg |
| CA3342 | 10 Uds. | 3,3 mm | 42 m | 0,660 kg |
| CA4029 | 10 Uds. | 4,0 mm | 29 m | 0,660 kg |



TUBO NYLON CUADRADO 3

| REF. | F. VENTA | ØNYLON | LARGO | PESO |
|--------|----------|--------|--------------|----------|
| TC3040 | 1 Ud. | 3,0 mm | 50ud x 40 cm | 0,130 kg |
| TC3340 | 1 Ud. | 3,3 mm | 50ud x 40cm | 0,130 kg |



**NYLON HELICOIDAL 1**

| REF. | F. VENTA | ØNYLON | LARGO | PESO | |
|-------|----------|--------|-------|----------|--|
| H3015 | 10 Uds. | 3,0 mm | 15 m | 0,140 kg | |
| H3050 | 10 Uds. | 3,0 mm | 50 m | 0,432 kg | |
| H3150 | 8 Uds. | 3,0 mm | 150 m | 1,500 kg | |
| H3315 | 10 Uds. | 3,3 mm | 15 m | 0,190 kg | |
| H3330 | 10 Uds. | 3,3 mm | 30 m | 0,340 kg | |
| H4015 | 10 Uds. | 4,0 mm | 15 m | 0,224 kg | |
| H4030 | 10 Uds. | 4,0 mm | 30 m | 0,224 kg | |

TUBO NYLON HELICOIDAL SILENT 2

| REF. | F. VENTA | ØNYLON | LARGO | PESO | |
|---------|----------|--------|--------------|---------|--|
| THS3040 | 1 Ud. | 3,0 mm | 50ud x 40 cm | 0,112kg | |
| THS3340 | 1 Ud. | 3,3 mm | 50ud x 40 cm | 0,101kg | |
| THS3940 | 1 Ud. | 3,9 mm | 50ud x 40cm | 0,116kg | |

NYLON DENTADO 3

| REF. | F. VENTA | ØNYLON | LARGO | PESO | |
|-------|----------|--------|-------|----------|--|
| D3037 | 1 Ud. | 3,0 mm | 37 m | 0,418 kg | |
| D3527 | 1 Ud. | 3,5 mm | 27 m | 0,427 kg | |
| D4021 | 1 Ud. | 4,0 mm | 21 m | 0,423 kg | |
| D4516 | 1 Ud. | 4,5 mm | 16 m | 0,392 kg | |



NYLON HELICOIDAL SILENT

| REF. | F. VENTA | ØNYLON | LARGO | PESO | |
|---------|----------|--------|-------|----------|--|
| HS2015 | 10 Uds. | 2,0 mm | 15 m | 0,725 kg | |
| HS2050 | 10 Uds. | 2,0 mm | 50 m | 0,207 kg | |
| HS2415 | 10 Uds. | 2,4 mm | 15 m | 0,101 kg | |
| HS2450 | 10 Uds. | 2,4 mm | 50 m | 0,277 kg | |
| HS3015 | 10 Uds. | 3,0 mm | 15 m | 0,139 kg | |
| HS3050 | 10 Uds. | 3,0 mm | 50 m | 0,425 kg | |
| HS3150 | 8 Uds. | 3,0 mm | 150 m | 1,500 kg | |
| HS3315 | 10 Uds. | 3,3 mm | 15 m | 0,180 kg | |
| HS3350 | 10 Uds. | 3,3 mm | 50 m | 0,630 kg | |
| HS33150 | 4 Uds. | 3,3 mm | 150 m | 1,925 kg | |
| HS4015 | 10 Uds. | 4,0 mm | 15 m | 0,242 kg | |
| HS4050 | 8 Uds. | 4,0 mm | 50 m | 1,087 kg | |
| HS4150 | 4 Uds. | 4,0 mm | 150 m | 2,525 kg | |
| HS4515 | 10 Uds. | 4,5 mm | 15 m | 0,242 kg | |
| HS4550 | 8 Uds. | 4,5 mm | 50 m | 1,087 kg | |
| HS45150 | 2 Uds. | 4,5 mm | 150 m | 2,525 kg | |

Un hilo de nylon helicoidal fabricado con un alto grado de durabilidad, por lo que presenta una excelente resistencia a la abrasión. Con su uso realizaremos un trabajo más eficiente y aumentaremos la vida útil de la desbrozadora. Muy silencioso por lo que ayuda a reducir la contaminación acústica.



TWIST

Núcleo resistente



Un hilo de nylon helicoidal con un recubrimiento externo que previene el pegado por temperatura. Tiene un núcleo interior resistente a las roturas.

| REF. | F. VENTA | Ø NYLON | LARGO |
|--------|----------|---------|-------|
| HT2715 | 10 Ud. | 2,7 mm | 15 m |
| HT2750 | 10 Ud. | 2,7 mm | 50 m |
| HT3015 | 10 Ud. | 3,0 mm | 15 m |
| HT3050 | 10 Ud. | 3,0 mm | 50 m |
| HT4015 | 10 Ud. | 4,0 mm | 15 m |
| HT4050 | 8 Ud. | 4,0 mm | 50 m |





NYLON PROFESIONAL



| REF. | COLOR | ØNYLON | LARGO | EMBALAJE | PERFIL |
|--------|-------|---------|------------|----------|---------|
| 6-1302 | NEGRO | 4,30 mm | 109 metros | bobina | ovalado |



| REF. | COLOR | ØNYLON | LARGO | EMBALAJE | PERFIL |
|--------|-------|---------|------------|----------|-------------------|
| 6-1292 | NEGRO | 3,90 mm | 128 metros | bobina | ovalado retorcido |



| REF. | COLOR | ØNYLON | LARGO | EMBALAJE | PERFIL |
|-------|-------|---------|-----------|----------|-------------------|
| 6-727 | NEGRO | 3,90 mm | 80 metros | bobina | ovalado retorcido |



| REF. | COLOR | ØNYLON | LARGO | EMBALAJE | PERFIL |
|-------|-------|---------|------------|----------|-------------------|
| 6-369 | NEGRO | 3,30 mm | 182 metros | bobina | ovalado retorcido |



| REF. | COLOR | ØNYLON | LARGO | EMBALAJE | PERFIL |
|-------|-------|---------|------------|----------|-------------------|
| 6-368 | NEGRO | 3,30 mm | 109 metros | bobina | ovalado retorcido |



| REF. | COLOR | ØNYLON | LARGO | EMBALAJE | PERFIL |
|-------|-------|---------|-----------|----------|-------------------|
| 6-130 | NEGRO | 4,30 mm | 21 metros | blister | ovalado retorcido |



| REF. | COLOR | ØNYLON | LARGO | EMBALAJE | PERFIL |
|-------|-------|---------|-----------|----------|-------------------|
| 6-129 | NEGRO | 3,90 mm | 26 metros | blister | ovalado retorcido |



| REF. | COLOR | ØNYLON | LARGO | EMBALAJE | PERFIL |
|-------|-------|---------|-----------|----------|-------------------|
| 6-128 | NEGRO | 3,30 mm | 37 metros | blister | ovalado retorcido |





4 330681 095773

B50080

| | |
|-----------------|--------------------------|
| B50080 | Bidón polietileno doble |
| Características | Homologado para gasolina |
| Capacidad | 5 L + 2,5 L |
| Peso | 0,850 kg |



4 330681 100119

B50079 VISOR

| | |
|-----------------|---------------------------|
| B50079 | Bidón polietileno c/visor |
| Características | Homologado para gasolina |
| Capacidad | 5 L |
| Peso | 0,679 kg |



4 330681 100120

B50078 VISOR

| | |
|-----------------|---------------------------|
| B50078 | Bidón polietileno c/visor |
| Características | Homologado para gasolina |
| Capacidad | 10 L |
| Peso | 1,070 kg |



4 330681 095775

B50077

| | |
|-----------------|--------------------------|
| B50078 | Bidón polietileno |
| Características | Homologado para gasolina |
| Capacidad | 20 L |
| Peso | 1,111 kg |





B50079 TRANSPARENTE

| | |
|---------------------|--------------------------|
| B50079 transparente | Bidón polietileno |
| Características | Homologado para gasolina |
| Capacidad | 5 L |
| Peso | 0,679 kg |



B50078 TRANSPARENTE

| | |
|---------------------|--------------------------|
| B50078 transparente | Bidón polietileno |
| Características | Homologado para gasolina |
| Capacidad | 10 L |
| Peso | 1,070 kg |



SG-L5

Bidón metálico gasolina 5 Litros

| | |
|-----------|---------|
| Capacidad | 5 L |
| Peso | 1,24 kg |



SG-L20

Bidón metálico gasolina 20 Litros

| | |
|-----------|---------|
| Capacidad | 20 L |
| Peso | 3,70 kg |



Acero laminado

CHAQUETA ACOLCHADA



TALLAS S-M-L-XL-XXL

CHALECO SPORTGARDEN



TALLAS S-M-L-XL-XXL

POLO SPORTGARDEN



TALLAS S-M-L-XL-XXL

CAMISA SPORTGARDEN



TALLAS S-M-L-XL-XXL

CHALECO DE TRABAJO



TALLAS S-M-L-XL-XXL

BATA DE TRABAJO



TALLAS S-M-L-XL-XXL

MOCHILA SPORTGARDEN



BANDERA PUBLICITARIA



LINEAL DE EXPOSICIÓN



PANEL FOTOGRÁFICO PVC



CUBO PEQUEÑO



CUBO GRANDE



PARAGUAS SG



RECAMBIOS

BATERÍAS

CORTACÉSPED

DESBROZADORA

HERRAMIENTAS

LIMPIEZA

MOTORES

MOTORES ELÉCTRICOS

MOTOSIERRAS

PULVERIZACIÓN

VAREADORES

BATERÍAS

BATERÍAS

BATERÍAS

| | SPORTGARDEN | SPORTGARDEN | SPORTGARDEN |
|------------------------|---|--|---|
| |  |  |  |
| Referencia | SG30323 | SG30324G | SG30325G |
| Características | BATERIA 12V-20Ah 181X76X167mm | BATERIA GEL 12V-24Ah | BATERIA GEL 12V-24Ah |

| | SPORTGARDEN | SPORTGARDEN | SPORTGARDEN |
|------------------------|--|---|---|
| |  |  |  |
| Referencia | SG30326G | SG30327G | SG30485 |
| Características | BATERIA GEL 12V-32Ah | BATERIA GEL 12-32Ah | ACIDO BATERIAS |

¿CONOCES NUESTRO B2B?

Bussiness to Bussiness

LLEGA A AUSAVIL
UN NUEVO MODELO
DE NEGOCIO.

Podrás acceder a nuestra plataforma online para poder realizar diferentes acciones los 365 días del año.

- Realizar pedidos de las marcas del grupo Ausavil.
- Consulta de histórico de pedidos, albaranes y facturas.
- Descarga de facturas, pedidos y albaranes.
- Consulta de stock.

SI REALIZAS EL PEDIDO A TRAVÉS
DE LA PLATAFORMA RECIBIRÁS UN
3% DE
DESCUENTO

AUSAVIL
custom-made machines

Pruebalo ya en

www.b2b.ausavil.com

CORTACÉSPED

CABLES Y OJALES
CUCHILLAS
RUEDAS









CABLES Y OJALES

| | SPORTGARDEN | SPORTGARDEN | SPORTGARDEN |
|------------------------|--|---|---|
| |  |  |  |
| Referencia | SG30338 | SG30339 | SG30340 |
| Características | CABLE RÍGIDO CON FINALES DE BAYONETA, LONGITUD 1800mm, LONGITUD FUNDA 1670mm | OJAL TIPO Z PARA CABLE | OJAL REDONDO Ø6,5mm PARA CABLE 2,5mm MAX |
| | SPORTGARDEN | SPORTGARDEN | |
| |  |  | |
| Referencia | SG30341 | SG30342 | |
| Características | OJAL TIPO Z PARA CABLE Ø2,5mm MAX | OJAL PARA CABLE Ø8mm PARA CABLE 2,5mm MAX | |

CUCHILLAS

| | HND | CSTL | CSTL |
|------------------------|---|--|---|
| |  |  |  |
| Referencia | SG30343 | SG30344 | SG30345 |
| Características | CUCHILLA CORTACESPED HND | CUCHILLA COMPATIBLE CASTELGARDEN | CUCHILLA COMPATIBLE CASTELGARDEN |
| Modelos | HRB535, HRB536, HRD535, HRD536, HRG536, HRH536, IZY 535 SDE 535X100X2,5 | ELECTRICO K350, P350, Mac 801-Mac 901 330X20X2,5 | CUCHILLA PARA TRACTORES CASTELGARDEN - HND - JHN DER - SAB - SLO - STG -VKNG. DIMENSIONES: L: 710 mm, AGUJERO CENTRAL: 18,5 mm, DISTANCIA ENTRE FUSIBLES: 65 mm. REEMPLAZA ORIGINAL: 184109500/0, 84109500/0, 84109502/0, 1136-0570-01, CG84109500H0, 664109502, SB84109500/0, 6126-702-0100. |

| | CSTL | CSTL | CSTL |
|------------------------|--|---|---|
| |  |  |  |
| Referencia | SG30346 | SG30347 | SG30348 |
| Características | CUCHILLA COMPATIBLE CASTELGARDEN | CUCHILLA COMPATIBLE CASTELGARDEN | CUCHILLA COMPATIBLE CASTELGARDEN |
| Modelos | CUCHILLA RH PARRA TRACTORES Twincut CSTLGRDN, HND, STG MODELO Estate Royal, VKNG. REEMPLAZA ORIGINAL: 182004341/1, 82004341/1, 82004341/0, 1136-1031-01, KIT DE CUCHILLA: 1134-9228-01, 72511-VK1-A11, CG82004341H1, CG82004341H0, 664004341, SB82004341/1, SB82004341/0, 6151-702-0105. L: 520mm, AGUJERO: 18,5mm, DISTANCIA ENTRE FUSIBLES: 65mm. | CUCHILLA LH PARA TRACTORES Twincut: CSTLGRDN, HND, STG MODELO Estate Royal, VIKING, JOHN DEERE MODELOS 12/38GR. REEMPLAZA ORIGINAL: 182004340/1, 82004340/1, 82004340/0, 1136-1030-01, KIT CUCHILLAS: 1134-9228-01, 72531-VK1-A11, CG82004340H1, CG82004340H0, SB82004340/1, SB82004340/1, 664004340, 6151-702-0100. L: 520mm, AGUJERO: 18,5mm, DISTANCIA ENTRE FUSIBLES: 65mm. | CUCHILLA LH for TRACTORES CSTLGRDN (TC, DLMR, HND, STG) MODELOS HF2113S, HF2114, HF2315 Twincut, JHN DER, SAB, SOL, STG MODELOS Estate Senator, Estate President, VKNG Type TC92. REEMPLAZA ORIGINAL: 182004344/1, 82004344/1, 82004344/0, 1136-0458-01, KIT CUCHILLAS: 1134-9224-01, 80394-Y09-003, 80394Y09003, 80111-VJ5-003, 80111VJ5003, CG82004344H1, CG82004344H0, SB82004344/1, SB82004344/0, 664531048, 6125-702-0100. |
| |  |  |  |
| Referencia | SG30349 | SG30350 | SG30351 |
| Características | CUCHILLA COMPATIBLECASTELGARDEN | CUCHILLA COMPATIBLE CASTELGARDEN | CUCHILLA COMPATIBLE CASTELGARDEN |
| Modelos | CUCHILLA RH PARA TRACTOR CSTLGRDN MODELO TC92/JUNIOR, HND MODELOS HF2113S, HF2114, HF2315 Twincut, JHN DEE, SAB, SOL, STG, VKNG type TC92. REEMPLAZA ORIGINAL: 182004345/1, 82004345/1, 82004345/0, 1136-0459-01, KIT CUCHILLAS: 1134-9224-01, 80395-Y09-003, 80395Y09003, CG82004345H1, CG82004345H0, SB82004345/1, SB82004345/0, 664004345, 6125-702-0105. | CUCHILLA MULCHING LH PARA TRACTORES CSTLGRDN, HND Y STG MODELO TC122 Estate Pro 20 - L: 620mm, AGUJERO CENTRAL: 18,5mm, DISTANCIA ENTRE FUSIBLES: 65mm. REEMPLAZO ORIGINAL: 80517-VK1-003, 80517VK1003, CG820-043-49H0, CG82004349H0, 182004349/0, 82004349/0, 80517-VK1-003, 6151 702 0111. | CUCHILLA MULCHING RH PARA TRACTOR CSTLGRDN, HND Y STG PARA MODELO TC122 Estate Pro 20 - L: 620mm, AGUJERO CENTRAL: 18,5mm, DISTANCIA ENTRE FUSIBLES: 65mm. REEMPLAZA ORIGINAL: 80518-VK1-003, 80518VK1003, CG820-043-50H0, CG82004350H0, CG82004350H0, 182004350/0, 82004350/0, 6151 702 0116. |



| | HND | KZ | KZ |
|------------------------|--|---|--|
| Referencia | SG30352 | SG30353 | SG30354 |
| Características | CUCHILLA COMPATIBLE HND | CUCHILLA COMPATIBLE KAAZ | CUCHILLA COMPATIBLE KAAZ |
| Modelos | CUCHILLA PARA CSTLGRDN MODELOS 430ER, 480ER. REEMPLAZA: 181004397/0, 81004397/0, 81004346/3, 81004346/2 - HND MODELOS HRF464S, HRF465P, HRF465S, HRD465, HRG465C, IZY 46 - McCLLCH, REEMPLAZA: 80067-VF4-003, CG81004397H0 - STG models Combi 48S, Turbo 48S. REEMPLAZA ORIGINAL: 81004397/0, 181004397/0, 81004346/0, 81004346/1, 81004346/2, 81004346/3, 1111-9193-01, 1111919301, CG81004397/H0. L: 460mm, AGUJERO: 18,5mm, DISTANCIA ENTRE FUSIBLES: 65mm. | CUCHILLA PARA KAZ - ORC - YNMR - L: 530mm, AGUJERO CENTRAL: 21,3mm, DISTANCIA ENTRE FUSIBLES: 90mm. REEMPLAZA ORIGINAL: 67614512, 676145120, 91014-0189, 91014-159, 91014-188, 910140189, 91014159, 91014188, 80-1020-821- 10, 676145120, 0268-72-100, 0268-72-110. | Blade for KAZ, ORC, YNMR - L: 476 mm, AGUJERO CENTRAL: 21.6 mm, DISTANCIA ENTRE FUSIBLES: 90 mm. REEMPLAZA ORIGINAL: 480-91014165, 80-1010-821-10, 67614510. |



| | HSQ | HSQ | SPORTGARDEN |
|------------------------|--|---|--|
| Referencia | SG30355 | SG30356 | SG30357 |
| Características | CUCHILLA COMPATIBLE HSQ | CUCHILLA COMPATIBLE HSQ | CUCHILLA MULCHING UNIVERSAL |
| Modelos | CUCHILLA LH PARA TRACTORES AY, BRNRD, ELCTRLX - HSQ, JHN DER MODELOS ICT13 Y ICT14 and JNSRD MODELOS ITC13, ITC14 - Mowing deck 92 cm - L: 545mm, AGUJERO CENTRAL: ESTRELLA 5 PUNTAS. REEMPLAZA ORIGINAL: 165560, 170037 | CUCHILLA RH PARA TRACTORES AY, BRNRD, ELCTRLX - HSQ, JHN DERE MODELOS ICT13 Y ICT14 Y JNSRD MODELOS ITC13, ITC14 - Mowing deck 92 cm - L: 465mm, AGUJERO CENTRAL: ESTRELLA 6 PUNTAS. REEMPLAZA ORIGINAL: 165561, 170038 | CUCHILLA MULCHING UNIVERSAL Longitud: 430mm, Taladro central: 10mm, Distancia entre centros: 55/98mm |



| | SPORTGARDEN | SPORTGARDEN | SPORTGARDEN |
|------------------------|--|--|---|
| Referencia | SG30358 | SG30359 | SG30360 |
| Características | CUCHILLA UNIVERSAL | CUCHILLA UNIVERSAL | CUCHILLA UNIVERSAL |
| Modelos | CUCHILLA MULCHING UNIVERSAL Longitud: 450mm, Taladro central: 10mm, Distancia entre centros: 55/98mm | CUCHILLA MULCHING UNIVERSAL Longitud: 480mm, Taladro central: 10mm, Distancia entre centros: 55/98mm | Cuchilla universal para cortacésped - Longitud: 530mm, Taladro central: 10mm, Distancia entre centros: 55/98mm. |

| | SPORTGARDEN | SPORTGARDEN | SPORTGARDEN |
|------------------------|---|--|---|
| |  |  |  |
| Referencia | SG30361 | SG30362 | SG30363 |
| Características | CUCHILLA UNIVERSAL | CUCHILLA UNIVERSAL | CUCHILLA UNIVERSAL |
| Modelos | Cuchilla universal para cortacésped - Longitud: 457mm, Taladro central: 25mm | Cuchilla universal para cortacésped - Longitud: 482mm, Taladro central: 25mm | Cuchilla universal para cortacésped - Longitud: 508mm, Taladro central: 25mm |

| | SPORTGARDEN | SPORTGARDEN | SPORTGARDEN |
|------------------------|---|--|---|
| |  |  |  |
| Referencia | SG30361 | SG30362 | SG30363 |
| Características | CUCHILLA UNIVERSAL | CUCHILLA UNIVERSAL | CUCHILLA UNIVERSAL |
| Modelos | Cuchilla universal para cortacésped - Longitud: 457mm, Taladro central: 25mm | Cuchilla universal para cortacésped - Longitud: 482mm, Taladro central: 25mm | Cuchilla universal para cortacésped - Longitud: 508mm, Taladro central: 25mm |

| | SPORTGARDEN | SPORTGARDEN | SPORTGARDEN |
|------------------------|---|--|---|
| |  |  |  |
| Referencia | SG30364 | SG31311 | SG31364 |
| Características | CUCHILLA UNIVERSAL | CUCHILLA | CUCHILLA |
| Modelos | Cuchilla universal para cortacésped - Longitud: 533mm, Taladro central: 25mm | original: 742-04058, 742-05116, 942-04058 (74204058, 94204058) | Blade for lawnmowers WOLF. Original RZ53VN |

| | SPORTGARDEN | SPORTGARDEN | SPORTGARDEN |
|------------------------|---|--|--|
| |  |  |  |
| Referencia | SG30365 | SG30366 | SG30367 |
| Características | ARANDELA PARA CUCHILLA UNIVERSAL Ø9.5mm | ARANDELA PARA CUCHILLA UNIVERSAL Ø11mm | ARANDELA PARA CUCHILLA UNIVERSAL Ø12.5mm |
| Modelos | Arandela reductora con diámetro ext de 25mm para cuchilla universal de cortacésped - Taladro central: 9,5mm | Arandela reductora con diámetro ext de 25mm para cuchilla universal de cortacésped - Taladro central: 11mm | Arandela reductora con diámetro ext de 25mm para cuchilla universal de cortacésped - Taladro central: 12,5mm |

| | SPORTGARDEN | SPORTGARDEN | SPORTGARDEN |
|------------------------|---|---|---|
| |  |  |  |
| Referencia | SG30368 | SG30469 | SG30470 |
| Características | ARANDELA PARA CUCHILLA UNIVERSAL Ø14.3mm | ARANDELA PARA CUCHILLA UNIVERSAL Ø15.9mm | ARANDELA PARA CUCHILLA UNIVERSAL Ø19.05mm |

| | SPORTGARDEN |
|------------------------|---|
| |  |
| Referencia | SG30471 |
| Características | ARANDELA PARA CUCHILLA UNIVERSAL Ø22.22mm |

RUEDAS

| | SPORTGARDEN | SPORTGARDEN | SPORTGARDEN |
|------------------------|---|--|---|
| |  |  |  |
| Referencia | SG30328 | SG30329 | SG30330 |
| Características | RUEDAS UNIVERSALES CORTACESPED | RUEDAS UNIVERSALES CORTACESPED | RUEDAS UNIVERSALES CORTACESPED |
| Modelos | CSTL ØEXT. 180mm ØINT. 11,6mm CON RODAMIENTO | HND ØEXT. 180mm ØINT. 12,75mm | UNIVERSAL ØEXT. 180mm CASQUILLOS: 8-10-12 Y 12,7 |

| | SPORTGARDEN | SPORTGARDEN | SPORTGARDEN |
|------------------------|---|---|---|
| |  |  |  |
| Referencia | SG30331 | SG30332 | SG30333 |
| Características | CUBIERTA RIGIDA CORTACESPED RUEDA | RUEDA 13X500X6mm | RUEDA 13X500X6mm |
| Modelos | COMPATIBLE CON HNDHRA216/2160, HRH536 EXT:220mm-INT:155mm | | |

| | SPORTGARDEN | SPORTGARDEN | SPORTGARDEN |
|------------------------|--|--|--|
| |  |  |  |
| Referencia | SG30334 | SG30335 | SG30336 |
| Características | RUEDA 16X650-8 | RUEDA 18X850-8 | CAMARA 15X600-6 |

| | SPORTGARDEN | SPORTGARDEN |
|------------------------|---|--|
| |  |  |
| Referencia | SG30337 | SG30488 |
| Características | CAMARA 16X650-8 | CAMARA 13X500-6 |

DESBROZADORA

**BARRAS
CABEZALES
CAMPANAS
MANILLARES
TUERCAS Y TORNILLOS**

BARRAS

| | SPORTGARDEN | SPORTGARDEN |
|------------------------|---|--|
| |  |  |
| Referencia | BARRA DELUXE GREENTIME | BARRA DELUXE PRO |
| Características | BARRA DESBROZADORA COLOR NEGRO GREENTIME | BARRA DESBROZADORA |

CABEZALES

| | SPORTGARDEN | SPORTGARDEN | SPORTGARDEN |
|------------------------|--|---|--|
| |  |  |  |
| Referencia | AOCT26Z7 | AOCT28Z7 | AUPS05 |
| Características | CABEZAL COMPLETO D.26 7 ESTRIAS | CABEZAL COMPLETO D.28 7 ESTRIAS | PROTECTOR BARRA DESBROZADORA |

| | SPORTGARDEN | SPORTGARDEN | SPORTGARDEN |
|------------------------|---|---|---|
| |  |  |  |
| Referencia | EBC4352BHN1 | EBC4352BHN13 | EBC4352BHN19 |
| Características | CABEZAL COMPLETO GBC | ARANDELA GUARDAPOLVOS GBC | ARANDELA INFERIOR GBC |

| | SPORTGARDEN | SPORTGARDEN | SPORTGARDEN |
|------------------------|---|---|---|
| |  |  |  |
| Referencia | EBC4352BHN20 | EBC4352BHN21 | EBC4352BHN83 |
| Características | ARANDELA SUPERIOR GBC | PROTECTOR ESTABILIZADOR | SOPORTE PROTECTOR GBC |

| | | | |
|------------------------|---|--|---|
| | SPORTGARDEN | SPORTGARDEN | SPORTGARDEN |
| |  |  |  |
| Referencia | EBC4352BHN85 | GP4352TN10 | GSC330CABEZAL |
| Características | PROTECTOR CABEZAL GBC | ARANDELA GUARDAPOLVOS | CABEZAL COMPLETO |
| | SPORTGARDEN | SPORTGARDEN | SPORTGARDEN |
| |  |  |  |
| Referencia | GSC330GRUPO | SG30257 | SG30259 |
| Características | GRUPO PODADOR | PROTECTOR ESTABILIZADOR 8mm | PROTECTOR ESTABILIZADOR Ø14mm |
| | SPORTGARDEN | SPORTGARDEN | SPORTGARDEN |
| |  |  |  |
| Referencia | SG30261 | SG30262 | SG30263 |
| Características | CABEZAL DESBROZADO UNIVERSAL PARA BARRA 24/26/28mm | ADAPTADOR CABEZAL UNIVERSAL 7 ESTRÍAS | ADAPTADOR CABEZAL UNIVERSAL 8 ESTRÍAS |
| Modelos | | ADAPTADOR PARA CABEZAL SG30261 PARA VARILLA 7 ESTRÍAS | ADAPTADOR CABEZAL UNIVERSAL (SG3026) 8 ESTRÍAS |
| | SPORTGARDEN | SPORTGARDEN | SPORTGARDEN |
| |  |  |  |
| Referencia | SG30264 | SG30265 | SG30266 |
| Características | ADAPTADOR CABEZAL UNIVERSAL 9 ESTRÍAS | ADAPTADOR CABEZAL UNIVERSAL 10 ESTRÍAS | ADAPTADOR CABEZAL UNIVERSAL CUADRADO 5.1mm |
| Modelos | ADAPTADOR CABEZAL UNIVERSAL (SG3026) 9 ESTRÍAS | ADAPTADOR CABEZAL UNIVERSAL (SG3026) 10 ESTRÍAS | ADAPTADOR CABEZAL UNIVERSAL (SG3026) CUADRADO 5.1mm |



| | | | |
|------------------------|---|---|--|
| Referencia | SG30267 | SG30268 | SG30269 |
| Características | ADAPTADOR CABEZAL UNIVERSAL CUADRADO 5.4mm | ADAPTADOR CABEZAL UNIVERSAL CUADRADO 6.0mm | ADAPTADOR CABEZAL UNIVERSAL STIHL 5.5mm |
| Modelos | ADAPTADOR CABEZAL UNIVERSAL (SG3026) CUADRADO 5.4mm | ADAPTADOR CABEZAL UNIVERSAL (SG3026) CUADRADO 6.0mm | ADAPTADOR CABEZAL UNIVERSAL (SG3026) STL 5.5mm |



| | | | |
|------------------------|--|--|---|
| Referencia | SG30270 | SG30271 | SG30272 |
| Características | ADAPTADOR CABEZAL UNIVERSAL STIHL 6.5mm | ADAPTADOR CABEZAL UNIVERSAL 11 ESTRÍAS | CASQUILLOS PLASTICO CABEZAL UNIVERSAL SG30261 |
| Modelos | ADAPTADORES 24mm, 25mm, 25,4mm, 26mm en 27mm | - | - |



| | | | |
|------------------------|---|---|-------------------------------------|
| Referencia | SG30283 | SG30284 | SG30285 |
| Características | PROTECTOR UNIVERSAL ADAPTADORES Ø24/26/28mm | PROTECTOR DESBRO MOCHILA 28mm (CON ADAP. 24/26mm) | CABEZAL COMPATIBLE STIHL |
| Modelos | | | COMPATIBLE CON FS500, FS550, FS550L |



| | | | |
|------------------------|--|------------------------------|--------------------------------------|
| Referencia | SG30286 | SG30287 | SG30505 |
| Características | CABEZAL COMPATIBLE CON STIHL | CABEZAL COMPATIBLE CON STIHL | ADAPTADOR CABEZAL GH 02 10125 M8-M10 |
| Modelos | FS160/180/220KL/280/280K/290/300/310/350/400/450/480 | COMPATIBLE CON FS/FR 80/85 | - |

| | SPORTGARDEN | SPORTGARDEN | SPORTGARDEN |
|------------------------|---|---|---|
| |  |  |  |
| Referencia | SG30506 | SG30507 | SG30508 |
| Características | ADAPTADOR CABEZAL GH02 10125 M10-M12 | ADAPTADOR CABEZAL GH02 10125 M8 | ADAPTADOR CABEZAL GH02 10125 M12 |

| | SPORTGARDEN | SPORTGARDEN |
|------------------------|---|--|
| |  |  |
| Referencia | TT508-1/21N | TT508-22/29 |
| Características | CABEZAL D.28 9 ESTRIAS CON PIN DE BLOQUEO | PARA BARRA Ø28 |

CAMPANAS

| | SPORTGARDEN | SPORTGARDEN | SPORTGARDEN |
|------------------------|---|--|---|
| |  |  |  |
| Referencia | AOSC26 | EBC4352BHN35 | GSC330CAMPANAC |
| Características | CAMPANA COMPLETA | CAMPANA COMPLETA GBC | CAMPANA COMPLETA |

MANILLARES

| | SPORTGARDEN | SPORTGARDEN | SPORTGARDEN |
|------------------------|---|--|---|
| |  |  |  |
| Referencia | AOAB26M19 | CG520-59 | EBC4352BHN5052Y55 |
| Características | ABRAZADERA MANILLAR B.26 M.19 | MANILLAR MAXIMA | ABRAZADERA MANILLAR B.28 M.19 |
| Modelos | | MAXIMA 52 | |

| | SPORTGARDEN | SPORTGARDEN | SPORTGARDEN |
|------------------------|---|--|---|
| |  |  |  |
| Referencia | EBC4352BHN58 | EBC4352BHPOMO | GP4352TN63-65 |
| Características | CABLE 800MM. SG000025 | POMO MANILLAR T.19 | ABRAZADERA MANILLAR B.28 M.19 |



| | SPORTGARDEN |
|------------------------|---|
| |  |
| Referencia | YK43 |
| Características | ABRAZADERA MANILLAR B.28 M.19 |

TUERCAS Y TORNILLOS

| | SPORTGARDEN | SPORTGARDEN | SPORTGARDEN |
|------------------------|---|---|---|
| |  |  |  |
| Referencia | SG30016 | SG30018 | SG30273 |
| Características | TUERCA M8*1.25 | TORNILLO ROSCA IZQ. M10*1.50 | TUERCA IZQ 8X125 |

| | SPORTGARDEN | SPORTGARDEN | SPORTGARDEN |
|------------------------|---|--|---|
| |  |  |  |
| Referencia | SG30274 | SG30275 | SG30276 |
| Características | TUERCA IZQ 10X100 | TUERCA IZQ 10X150 | TUERCA IZQ 10X125 |

| | SPORTGARDEN | SPORTGARDEN | SPORTGARDEN |
|------------------------|---|--|---|
| |  |  |  |
| Referencia | SG30277 | SG30278 | SG30279 |
| Características | TUERCA IZQ 12X150 | TUERCA IZQ 12X175 | TORNILLO CABEZAL 7X100X16 |

| | SPORTGARDEN | SPORTGARDEN | SPORTGARDEN |
|------------------------|---|--|---|
| |  |  |  |
| Referencia | SG30280 | SG30281 | SG30282 |
| Características | TORNILLO CABEZAL 8X125X20 | TORNILLO CABEZAL 10X125X20 | TORNILLO CABEZAL 10X150X20 |



HERRAMIENTAS

HERRAMIENTAS
RAMPAS

HERRAMIENTAS

| | SPORTGARDEN | SPORTGARDEN | SPORTGARDEN |
|------------------------|---|--|---|
| |  |  |  |
| Referencia | SG300431 | SG300432 | SG300433 |
| Características | KIT LLAVES CARBURACION | LLAVE REGULACION CARBURADOR WALBRO-ZAMA ESTRELLA | LLAVE REGULACION CARBURADOR WALBRO-ZAMA ESQUINA AFILA |

| | SPORTGARDEN | SPORTGARDEN | SPORTGARDEN |
|------------------------|---|--|---|
| |  |  |  |
| Referencia | SG300434 | SG300435 | SG300436 |
| Características | LLAVE REGULACION WALBRO-ZAMA AFILADA EN D | LLAVE REGULACION WALBRO-ZAMA AFILADA DOBLE D | LLAVE REGULACION ECH 2,5 x 75mm |

| | SPORTGARDEN | SPORTGARDEN | SPORTGARDEN |
|------------------------|---|---|---|
| |  |  |  |
| Referencia | SG30083 | SG30491 | SG30504 |
| Características | SPRAY LIMPIACARBURADORES | KIT ASPIRACION ACEITE | LLAVE ALLEN 5MM |

| | SPORTGARDEN |
|------------------------|---|
| |  |
| Referencia | SG31308 |
| Características | LIMPIADOR CHICLES CARBURADOR |

RAMPAS

SPORTGARDEN



| | |
|------------------------|------------------|
| Referencia | SG30511 |
| Características | RAMPAS PLEGABLES |

SPORTGARDEN

SPORTGARDEN

SPORTGARDEN



| | | | |
|------------------------|-----------------------|-----------------------|-----------------------|
| Referencia | 2304084 | 2304086 | 2304080 |
| Características | LLAVE DE BUJIAS 17/19 | LLAVE DE BUJIAS 16/13 | LLAVE DE BUJIAS 13/19 |



LIMPIEZA

BOMBAS
BOQUILLAS
FILTROS
LANZAS
PISTOLAS

BOMBAS

SPORTGARDEN



SPORTGARDEN



SPORTGARDEN



| | | | |
|------------------------|-----------------------|----------------------------------|------------------------|
| Referencia | DBC-1512C2 | DBC-1507A1 | DBD-1812C3 |
| Características | BOMBA 152/9 ELECTRICA | BOMBA 206/13 (MAQUINAS GASOLINA) | BOMBA 206/13 ELECTRICA |

SPORTGARDEN



| | |
|------------------------|-------------------------|
| Referencia | 3WZ1510A |
| Características | BOMBA 247BAR 17L/minuto |

BOQUILLAS

SPORTGARDEN



SPORTGARDEN



SPORTGARDEN



| | | | |
|------------------------|-----------------------|---------------------------------|----------------------------------|
| Referencia | DNSBT2 | 00040B | 15040 |
| Características | BOQUILLA TURBO 247/17 | BOQUILLA ACOPLAMIENTO RAPIDO 0° | BOQUILLA ACOPLAMIENTO RAPIDO 15° |

SPORTGARDEN



SPORTGARDEN



SPORTGARDEN



| | | | |
|------------------------|----------------------------------|----------------------------------|------------------------------------|
| Referencia | 25040 | 40040 | 60400 |
| Características | BOQUILLA ACOPLAMIENTO RAPIDO 25° | BOQUILLA ACOPLAMIENTO RAPIDO 40° | BOQUILLA ACOPLAMIENTO RAPIDO JABON |

| | SPORTGARDEN | SPORTGARDEN |
|------------------------|---|--|
| |  |  |
| Referencia | DNSBT | DNBMP |
| Características | BOQUILLA TURBO 206/13 Y 152/9 | BOQUILLA MULTIPOSICION |

FILTROS

| | SPORTGARDEN |
|------------------------|---|
| |  |
| Referencia | SGHFILTRO |
| Características | FILTRO ENTRADA GRANDE |

LANZAS

| | SPORTGARDEN | SPORTGARDEN | SPORTGARDEN |
|------------------------|---|--|---|
| |  |  |  |
| Referencia | DNLANZA1 | SGH130NA41 | SGHLANTUR |
| Características | CONEXIÓN DE ENTRADA M22X1.5-CONE- XIÓN DE SALIDA ENCHUFE RÁPIDO 1/4 | CONEXIÓN DE ENTRADA M22X1.5-CONE- XIÓN DE SALIDA ENCHUFE RÁPIDO 1/4 | LANZA TURBO CON ENTRADA M22X1.5 |

PISTOLAS



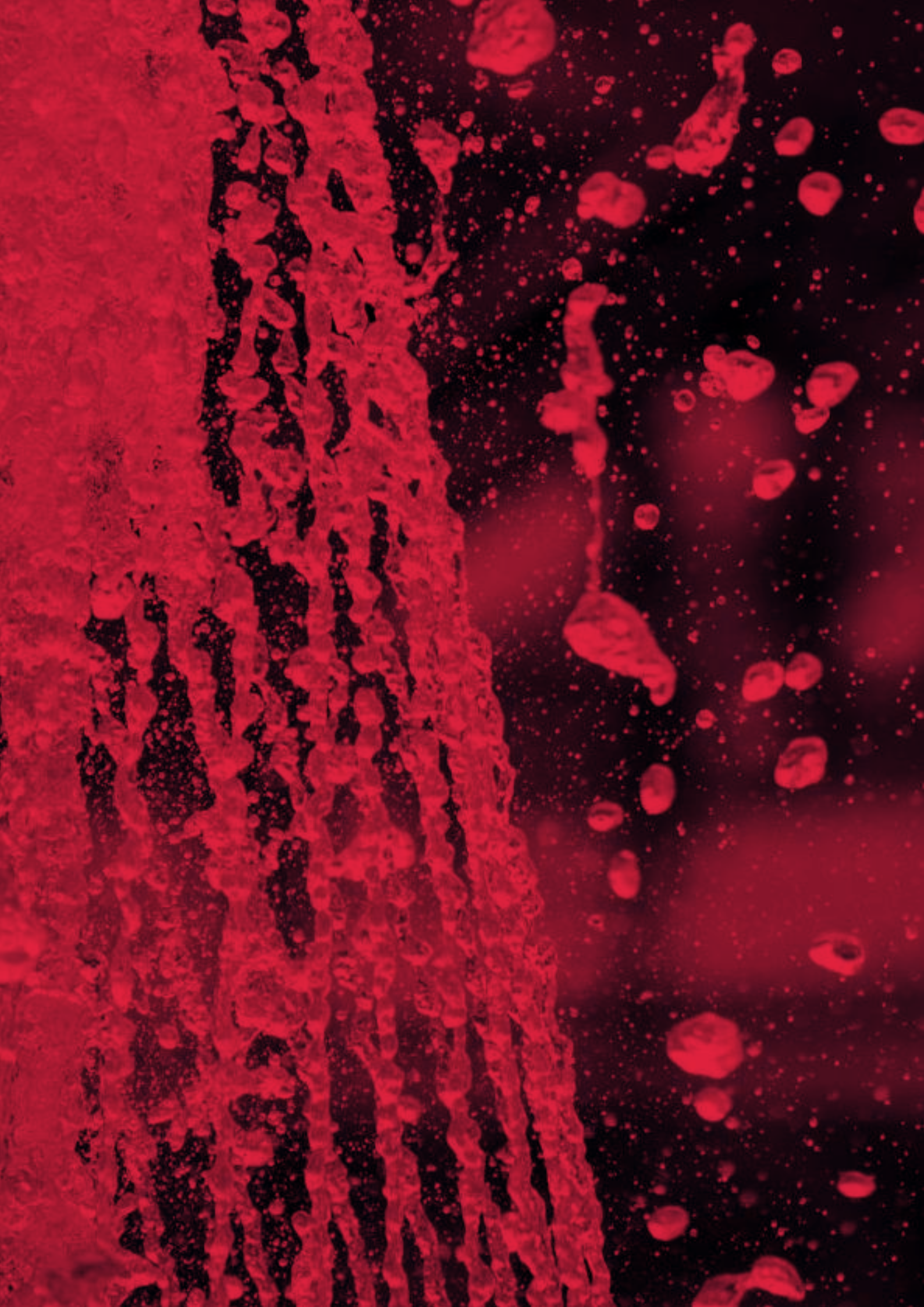









| | SPORTGARDEN | SPORTGARDEN |
|------------------------|---|--|
| |  |  |
| Referencia | DNPISTOLA1 | SGH130NA42 |
| Características | PISTOLA + PROLONGACION CON EN- CHUFE | PISTOLA |



MOTORES

ARRANQUES
BOBINAS
CABLES BUJÍAS
CALAS BUJÍAS
CAMPANAS ARRANQUE
CAPUCHONES DE BUJÍA
CARBURADORES
CEBADORES
CIGUEÑALES
CILINDROS
CORREAS
CUENTAHORAS
DEPÓSITOS
EMBRAGUES
ESCAPES
FILTROS DE AIRE
FILTROS DE GASOLINA
INTERRUPTORES
JUNTAS
KIT DE AROS
KIT DE CILINDROS
MEMBRANAS
MOTOR GASOLINA
MUELLE ACELERADOR
MUELLE ARRANQUE
MUELLE EMBRAGUE
MUELLE VÁLVULA
PIPA BUJÍA
PISTONES
PLATO MAGNÉTICO
POLEA DE ARRANQUE
POMO DE ARRANQUE
RETENES
TAPÓN COMBUSTIBLE
TIRADOR DE ARRANQUE
TOMA DE ADMISIÓN
TUBOS DE GASOLINA
VÁLVULAS

ARRANQUES

| KAW | | KAW | | KAW | |
|---|---|---|---|---|----------------------------------|
|  | |  | |  | |
| Referencia | 490880710 | 490880711 | 490880711 | 490882442 | 490882442 |
| Características | ARRANQUE COMPLETO TJ045E-KS51 | ARRANQUE COMPLETO TJ053E-AS50 | ARRANQUE COMPLETO TJ053E-AS50 | ARRANQUE COMPLETO TH048D | ARRANQUE COMPLETO TH048D |
| KAW | | KAW | | KAW | |
|  | |  | |  | |
| Referencia | 490882489 | 490882515 | 490882515 | 490882530 | 490882530 |
| Características | ARRANQUE COMPLETO (490882489) ARRANQUE TH23 Y TH26 | ARRANQUE COMPLETO TH023V-AF90 | ARRANQUE COMPLETO TH023V-AF90 | ARRANQUE COMPLETO TJ027D | ARRANQUE COMPLETO TJ027D |
| KAW | | HND | | SPORTGARDEN | |
|  | |  | |  | |
| Referencia | 490882544 | 140FA.2 | 140FA.2 | GBC4352N83 | GBC4352N83 |
| Características | ARRANQUE COMPLETO TH048 AF/ TH043D | ARRANQUE | ARRANQUE | ARRANQUE COMPLETO GBC | ARRANQUE COMPLETO GBC |
| Modelos | | GX35 COPIA | GX35 COPIA | GBC 520/430 TL43 Y TL52 MODERNOS | GBC 520/430 TL43 Y TL52 MODERNOS |
| SPORTGARDEN | | SPORTGARDEN | | HND | |
|  | |  | |  | |
| Referencia | GPM4352TN66 | GSC330N75 | GSC330N75 | SG30009 | SG30009 |
| Características | | | | | |
| Modelos | MÁXIMA ARRANQUE FÁCIL | VALE EL ARRANQUE CON LA REFEREN- CIA 6102410 DE KNC Y DE LA MOTOBOM- BA ST 10A SP | VALE EL ARRANQUE CON LA REFEREN- CIA 6102410 DE KNC Y DE LA MOTOBOM- BA ST 10A SP | GX110/120/140/160/200 | GX110/120/140/160/200 |

| | HND | HND | HND |
|------------------------|---|--|---|
| |  |  |  |
| Referencia | SG30010 | SG30030 | SG30031 |
| Características | VASO DE ARRANQUE GX160 | ARRANQUE COMPLETO GX120/140/160/200 | ARRANQUE COMPLETO GX340/390 |
| Modelos | | SIRVE PARA F65B REF. ORIGINAL HND: 28400-ZH8-013ZA | REF. ORIGINAL HND: 28400-ZE3-W01ZA |

| | HND | HND | HND |
|------------------------|---|--|---|
| |  |  |  |
| Referencia | SG30032 | SG30034 | SG30038 |
| Características | | | ARRANQUE BS QUANTUM |
| Modelos | GCV135/160 GC135/160 REF. ORIGINAL 28400-Z01-V20Za | REF. ORIGINAL HND: 28400-ZE2-W01ZA | REF. ORIGINAL BS:497680 |

| | STL | STL |
|------------------------|---|--|
| |  |  |
| Referencia | SG300426 | SG300427 |
| Características | | |
| Modelos | Arranque STL FS120, FS200 (4134-080-2101) | Arranque STL FS450 (4128-080-2101, 41280802101) |









| | HND | HND | STL |
|------------------------|--|---|---|
| |  |  |  |
| Referencia | SG30425 | SG30606 | SG30609 |
| Características | ARRANQUE COMPLETO GX100 | ARRANQUE COMP HND | ARRANQUE COMP STL |
| Modelos | HND 28400-Z0D-V02ZB, 28400-Z0D-V02ZC, 28400-Z0D-V03ZC, 28400-Z0D-V04ZA, 28400-Z0D-V04ZC, 28400Z0DV02ZB, 28400Z0DV02ZC, 28400Z0DV03ZC, 28400Z0DV04ZA, 28400Z0DV04ZC GX100 | ARRANQUE COMPLETO CON 2 TRINQUETES METÁLICOS Y VASO METÁLICO PARA HND GX160. REEMPLAZA ORIGINAL 28400-ZH8-023YA, 28400-ZH8-033YA. | STL 1137-084-1000, 11370841000 MS191, MS192, MS193 |

| | STL | STL |
|------------------------|---|--|
| |  |  |
| Referencia | SG30610 | SG30613 |
| Características | ARRANQUE COMP STL | ARRANQUE COMP STL |
| Modelos | STL 1129-080-2100, 1129-080-2101, 1129-080-2102, 1129-080-2105, 11290802100, 11290802101, 11290802102, 11290802105 020 type 1129, MS200 | STL 4203-190-0405, 42031900405 BR320, BR340, BR380, BR400, BR420, SR320, SR340, SR400, SR420 |

| | KAW | STL | KAW |
|------------------------|---|--|---|
| |  |  |  |
| Referencia | SG30917 | SG31080 | SG31322 |
| Características | ARRANQUE TH48 EQUIV 490882442 | ARRANQUE STL | ARRANQUE KW |
| Modelos | | ARRANQUE COMPLETO STL PARA SOPLADORES BR500, BR550, BR600. REEMPLAZA ORIGINAL 4282 190 0300, 4282 190 0300A. | KW 49088-0711, 490880711 TJ53 |

| | HND |
|------------------------|---|
| |  |
| Referencia | SGXG25-21 |
| Características | ARRANQUE COMPLETO |
| Modelos | HND 28400-Z0H-003, 28400-Z0H-315, 28400Z0H003, 28400Z0H315 GX24, GX25 |

BOBINAS

| | KAW | KAW | HND |
|------------------------|---|---|---|
| |  |  |  |
| Referencia | 211712292 | 590662823 | 140FA.7-1 |
| Características | BOBINA ENCENDIDO TJ053E-AS50 | SOPORTE BOBINA tj53 | BOBINA GX35 |
| | SPORTGARDEN | KAW | KAW |
| |  |  |  |
| Referencia | KE04024AA | SG30298 | SG30299 |
| Características | BOBINA ENCENDIDO TL52 PFD/TL43 PFD | BOBINA COMPATIBLE CON KAW | BOBINA COMPATIBLE KAW TJ45 |
| Modelos | | 21171-2193 TD33-40-48 | |
| | STL | STL | STL |
| |  |  |  |
| Referencia | SG30572 | SG30574 | SG30891 |
| Características | BOBINA STL | BOBINA STL | BOBINA STL |
| Modelos | 41284001306 STL FS400-450-480 | BOBINA ENCENDIDO STL MODELOS BR500, BR550, BR600, BR700. REEMPLAZA ORIGINAL 4282-400-1305, 4282-400-1308. | BOBINA ENCENDIDO STL MODELOS SR340, SR420, BR340, BR380, BR420. REEMPLAZA ORIGINAL 0000 400 1306, 4203 400 1301 |

| | STL | HND |
|------------------------|---|---|
| |  |  |
| Referencia | SG31316 | SGXG25-30 |
| Características | BOBINA ENCENDIDO STL | BOBINA GX25 |
| Modelos | BOBINA ENCENDIDO STL MODELOS FR160, FR220, FS160, FS180, FS200, FS220, FS220K, FS280, FS280K, FS290 Y SR340, SR420, BR340, BR380, BR420. REEMPLAZA ORIGINAL: 0000-400-1306, 4203 400 1301 (ATENCIÓN: ESPECÍFICO PARA DESBROZADORAS. NO SIRVE PARA MOTOSIERRAS.) | |

NGK



2 uds

Referencia

Características

Modelos

| | | |
|------------------|---|--|
| B4LM | BUJIA NGK | |
| B7HS | BUJIA NGK | |
| BM6A | BUJIA NGK | |
| BP5ES | BUJIA NGK | |
| BPM7A | BUJIA NGK MOTOSIERRAS Y DESBROZA- DORAS | |
| BPMR6A | BUJIA NGK | |
| BPMR7A | BUJIA NGK | |
| BPR5ES-11 | BUJIA NGK | |
| BPR6ES | BUJIAS NGK PARA CORTA- CESPEDES Y MOTOAZADAS | |
| CMR5H | BUJIA NGK | |
| CMR6A | BUJIA NGK | |
| CMR6H | BUJIA NGK | |
| CMR7H | BUJIA NGK | |
| SG30013 | BUJIA MOTO- SIERRAS Y DES- BROZADORAS | SG 30013 - PARA MOTOSIERRAS Y DESBROZADORAS MOBISERRA 8595001307132 |
| SG30014 | BUJIA CORTA- CESP. MOTOR BS 3.5/5 HP | SG 30014 - PARA CORTACESPEDES Y MOTORES BS 3.5/5 HP MOBISERRA 8595001307330 |
| SG30015 | BUJIA CORTA- CESP.MOTOAZ. MOTOR GX160 | SG 30015 - PARA CORTACESPEDES, MOTOAZADAS Y MOTORES HNDGX160 MOBISERRA 8595001303578 |
| SG30489 | BUJIA COMPATI- BLE GX35 | |

CABLES BUJÍAS

SPORTGARDEN

SPORTGARDEN



| | | |
|-----------------|--------------------|--------------------|
| Referencia | SG30514 | SG30515 |
| Características | CABLE BUJIA 5MM 2M | CABLE BUJIA 7MM 2M |

CALAS

| | HND | HND | HND |
|------------------------|---|--|---|
| |  |  |  |
| Referencia | 140F-9 | SG30006 | SG30008 |
| Características | CALA DE ACEITE GX110/120/140/160/20 | CALA DE ACEITE GX240/270/340/390 | CALA DE ACEITE GX240/270/340/390 |

CAMPANAS ARRANQUE

| | KAW | SPORTGARDEN | HND |
|------------------------|--|---|--|
| |  |  |  |
| Referencia | 490800707 | GSC330N12-14 | SGXG25-20 |
| Características | CAMPANA DE ARRANQUE TJ053E-AS50 | CAMPANA DE ARRANQUE GSC | CAMPANA DE ARRANQUE HND GX25 |

CAPUCHONES DE BUJÍA

| | SPORTGARDEN | SPORTGARDEN | SPORTGARDEN |
|------------------------|---|--|---|
| |  |  |  |
| Referencia | SG30291 | SG30292 | SG30293 |
| Características | CAPUCHON BUJIA ESTANDAR 7mm | CAPUCHON BUJIA ESTANDAR 5mm | CAPUCHON BUJIA ESTANDAR ROSCA INTERIOR 5mm |



| | SPORTGARDEN | SPORTGARDEN | HND |
|------------------------|---|--|---|
| |  |  |  |
| Referencia | SG30294 | SG30295 | SG30296 |
| Características | CAPUCHON BUJIA ESTANDAR ROSCA INTERIOR 7mm | CAPUCHON PARA BUJIAS NGK | CAPUCHON COMPATIBLE CON HNDG Y GX |



| KAW | SPORTGARDEN | |
|---|--|----------------|
|  |  | |
| Referencia | SG30297 | SG30513 |
| Características | CAPUCHON COMPATIBLE CON KAW | CAPUCHON BUJIA |

CARBURADORES

| KAW | HND | SPORTGARDEN | |
|---|---|---|--|
|  |  |  | |
| Referencia | 150042100 | 140FA-12 | GBC4352N68 |
| Características | CARBURADOR TJ053E-AS50 | CARBURADOR GX35 | CARBURADOR GBC |
| Modelos | TAMBIEN 15004-0841 | GX35 COPIA | GBC 430 / 520 KBC 52 / TL43 / TL52 IE40F (MOTOBOMBA ST 10A SP) WYK-28B |

| HND | HND | HND | |
|---|--|---|------------------|
|  |  |  | |
| Referencia | SG30020 | SG30022 | SG30023 |
| Características | CARBURADOR GX 120/140/160 | CARBURADOR GX270 | CARBURADOR GX390 |
| Modelos | COMPATIBLE MZ500CARB - HAG-040 | HAG-026 | HAG-013 |

| BS | HND | HND | |
|---|--|---|----------------------|
|  |  |  | |
| Referencia | SG30069 | SG30070 | SG30071 |
| Características | CARBURADOR BS | CARBURADOR HND GX240 | CARBURADOR HND GX340 |
| Modelos | kit carburador y depósito combustible BRI-GGS & STRATTON Sprint & Quattro | 16100-ZE2-W71 | 16100-ZE3-V01 |

| | HSQ | HSQ | HSQ |
|------------------------|---|--|---|
| |  |  |  |
| Referencia | SG30072 | SG30073 | SG30074 |
| Características | CARBURADOR HSQ | CARBURADOR HSQ | CARBURADOR HSQ |
| Modelos | 5300354-82; 530 07 19-87 136/137/141/142 | 503 28 32-10 340/345/346XP/350/353 | 503 28 03-16 Husq 61/66/261/262/266/268/272 (actual) |

| | HSQ | STL | STL |
|------------------------|---|--|---|
| |  |  |  |
| Referencia | SG30075 | SG30076 | SG30077 |
| Características | CARBURADOR HSQ | CARBURADOR STL | CARBURADOR STL |
| Modelos | CARBURADOR HSQ 268, 272. ORIGINAL TILLTS HS600. | 1130 120 0603 MS170/180 | 038/MS380/MS381 |

| | STL | STL | STL |
|------------------------|---|--|---|
| |  |  |  |
| Referencia | SG30078 | SG30079 | SG30080 |
| Características | CARBURADOR STL | CARBURADOR STL | CARBURADOR STL |
| Modelos | CARBURADOR STL 036 & MS360. REEM- PLAZA 1125-120-0651 | 1123 120 0603 021/023/025/MS210 | 1130 120 0603 017/018/MS170/MS180 |

| | STL | STL | HSQ |
|------------------------|---|---|---|
| |  |  |  |
| Referencia | SG30081 | SG30082 | SG30468 |
| Características | CARBURADOR STL | CARBURADOR STL | CARBURADOR HSQ |
| Modelos | CARBURADOR STL 064, 065, 066, MS640, MS650, MS660. REEMPLAZA ORIGINAL WALBRO WJ76A. | CARBURADOR STL 029, 039, MS290, MS310 & MS390. REEMPLAZA 1127-120- 0650 | 362/365/371XP/372 ZAMA 2165-2171 |

| | CRF | ECH | STL |
|------------------------|--|--|--|
| |  |  |  |
| Referencia | SG30578 | SG30580 | SG30588 |
| Características | CARBURADOR CFR | CARBURADOR ECH | CARBURADOR STL |
| Modelos | CARBURADOR EF 8460, 8465, 8530, 8535, 8550 - OL MC models 446, 453, 746, 753, 755. REEMPLAZA 2318630, 2318968AR, WLBR WYK-143-A. CFRLL | CARBURADOR ECH A021001870. A021003940 | CARBURADOR STL 020, 020T, MS200, MS200T. REEMPLAZA ORIGINAL 1129-120-0653 - ZAMA C1Q-S126. |

| | STL | STL | STL |
|------------------------|---|---|--|
| |  |  |  |
| Referencia | SG30592 | SG30593 | SG30594 |
| Características | CARBURADOR STL | CARBURADOR STL | CARBURADOR STL |
| Modelos | CARBURADOR STL REEMPLAZA ORIGINAL 4128-120-0600A, C1Q-S34H. PARA MÁQUINAS FS400, FS450, FS480, SP400 Y SP450. | CARBURADOR STL BR320, SR320, BR400, BR450. | CARBURADOR STL PARA SOPLADORES BR500, BR550, BR600. REEMPLAZA ORIGINAL C1Q-S183, 4282-120-0606, 4282-120-0607, 4282-120-0608, 4282-120-0610, 4282-120-0611, 4282-120-0612. |

| | STL | ALPN | ALPN |
|------------------------|---|---|---|
| |  |  |  |
| Referencia | SG31319 | SG31348 | SG31357 |
| Características | | | |
| Modelos | REEMPLAZA 41281200551 | CARBURADOR VIP 52 WB WT-305-716 | Carburetor for HND engines GCV135 and GCV160. Replaces original 16100-ZM0-804, 16100-Z0L-003, 16100-Z0L-013, 16100-Z0L-023, 16100-ZM0-003, 16100-ZM0-013, 16100-ZM0-023, 16100-ZM0-801, 16100-ZM0-802, 16100-ZM0-803, 16100-ZM1-825 |

HND



| | |
|------------------------|------------------|
| Referencia | SGXG25-42 |
| Características | CARBURADOR |
| Modelos | GX25 |

CEBADORES

BS



BS



SPORTGARDEN



| | | | |
|------------------------|--|---|-----------------------------------|
| Referencia | SG30448 | SG30449 | SG30450 |
| Características | | | |
| Modelos | BS (694394) FITS 3,5; 3,75; 4,0HP Quantum Series | BS (694395) Fits 5,0; 5,5; 6,0HP Quantum Series | Carburadores Walbro (188-11-1) WZ |

SPORTGARDEN



SPORTGARDEN



SPORTGARDEN



| | | | |
|------------------------|--|---|--------------------------------------|
| Referencia | SG30451 | SG30452 | SG30453 |
| Características | | | |
| Modelos | Carburadores Walbro (188-12-1) WA, WT, WY, WYJ, WYK, WYL | Carburadores Walbro (188-13-1) HDA, WYK | Carburadores Zama (0057004) C1U, C1Q |

SPORTGARDEN



SPORTGARDEN



SPORTGARDEN



| | | | |
|------------------------|--|--|--|
| Referencia | SG30454 | SG30455 | SG30456 |
| Características | | | |
| Modelos | Carburadores Walbro (188-512-1) WT, WYJ, WYK | Poulan (530071835); Walbro (188-513-1) | Poulan (530038874); Walbro (188-519-1) |

STL



| | |
|------------------------|---------------------------|
| Referencia | SG31325 |
| Características | CEBADOR CON MUELLE STL |
| Modelos | REEMPLAZA A 0000 350 6202 |

CIGUEÑALES

HND



SPORTGARDEN



| | | |
|------------------------|------------------|-------------------|
| Referencia | 140FA.3.1 | KD01017AA |
| Características | CIGUEÑAL | CIGÜEÑAL TL52 PFD |
| Modelos | GX35 COPIA | |

CILINDROS

HND



| | |
|------------------------|--------------------|
| Referencia | 140FA.1.1.1 |
| Características | |
| Modelos | GX35 COPIA |

CORREAS

HND





| | |
|------------------------|---------------------|
| Referencia | 140FA-3 |
| Características | CORREA DISTRIBUCION |
| Modelos | GX35 |

CUENTAHORAS

| | SPORTGARDEN | SPORTGARDEN |
|------------------------|---|---|
| |  |  |
| Referencia | HM019R | HM058B |
| Características | CUENTAHORAS | CUENTA HORAS Y RPM CON PARCIALES |
| Modelos | | |

DEPÓSITOS

| | KAW | HND | SPORTGARDEN |
|------------------------|--|---|--|
| |  |  |  |
| Referencia | 510012343 | 140FA.5-1 | GBC4352N100 |
| Características | | GX35 COPIA | |
| Modelos | DEPOSITO COMBUSTIBLE TJ053E | | MÁXIMA 52 |

| | HND | HND | HND |
|------------------------|---|---|--|
| |  |  |  |
| Referencia | SG30066 | SG30067 | SG30068 |
| Características | DEPOSITO DE GASOLINA GX140/160/200 | DEPOSITO DE GASOLINA GX240/270 | DEPOSITO DE GASOLINA GX340/390/MZ50 |
| Modelo | REF. ORIGINAL HND: 17510-ZE1-010ZA | EQUIVALE A LAS REFERENCIAS DE SU-MEC: SF173F-1070200 + SF160F-1070100 REF. ORIGINAL HND: 17510-ZE2-010ZA | EQUIVALE A LAS REFERENCIAS DE SU-MEC: SF188F-1071000 + SF160F-1070100 REF. ORIGINAL HND: 17510-ZE3-010ZA -AS40T -SG BIOT15HP |

| | STL | KAW | HND |
|------------------------|---|--|---|
| |  |  |  |
| Referencia | SG31320 | SG31363 | SGXG25-77 |
| Características | DEPOSITO STL | DEPOSITO TD40 | DEPOSITO GASOLINA |
| Modelos | REEMPLAZA A 11303500410 | | GX25 |

| | HND | HND |
|------------------------|---|--|
| |  |  |
| Referencia | GBC4352N99 | 140F-26 |
| Características | TAPON DEPOSITO GBC | SOPORTE DEPOSITO COMBUSTIBLE |
| Modelos | | GX35 |

EMBRAGUES

| | KAW | KAW | KAW |
|------------------------|---|--|---|
| |  |  |  |
| Referencia | 130812207 | 130812220 | 130812221 |
| Características | EMBRAGUE TH023V-AF90 | EMBRAGUE TH043D/TJ045E | EMBRAGUE TH048D |
| Modelos | | | |

| | KAW | KAW | KAW |
|------------------------|---|--|---|
| |  |  |  |
| Referencia | 130812224 | 130812225 | 130812232 |
| Características | EMBRAGUE TJ053E-AS50 (130810605) | EMBRAGUE TH023D-AF30 | EMBRAGUE TJ027D |
| Modelos | TAMBIEN 13081-0635 | | TAMBIEN 13081-2239 2080 |

| | SPORTGARDEN | SPORTGARDEN | STL |
|------------------------|---|---|--|
| |  |  |  |
| Referencia | GBC4352N38 | KT14001AA | SG300419 |
| Características | EMBRAGUE GBC | TORNILLO EMBRAGUE TL52 PFD/TL43 PFD | EMBRAGUE |
| Modelos | GBC 430 / GBC 520 KBC 52 / KBC 40 / KBC 33 TL52 / TL43 TH48 / TH43 | | STL replaces original 4119-160-2001, on machines FS160, FS180, FS220, FS280 and FS290. |

| | HSQ | HSQ | HSQ |
|------------------------|--|--|--|
| |  |  |  |
| Referencia | SG300420 | SG30159 | SG30160 |
| Características | EMBRAGUE | EMBRAGUE COMP HSQ | EMBRAGUE COMP HSQ |
| Modelos | Embrague para motosierras HUSQ 39R, 40, 45, 49, 240, 240R, 245, 245R, 245FX (5016360-04, 5016360-06, 5031731-02) | 503 81 59-01 340, 345, 350 | 503 74 44-01 363, 365, 371, 372 |

| | HSQ | HSQ | HSQ |
|------------------------|---|---|---|
| |  |  |  |
| Referencia | SG30161 | SG30162 | SG30163 |
| Características | EMBRAGUE COMP HSQ | EMBRAGUE COMP HSQ | EMBRAGUE COMP HSQ |
| Modelos | 501 45 54-03 51, 55 | EMBRAGUE HSQ PARA 268 Y 272. REEMPLAZA A: 503 74 44 02 | 530 01 49-49 36, 41, 136, 137, 141, 142 |

| | HSQ | HSQ | HSQ |
|------------------------|---|--|---|
| |  |  |  |
| Referencia | SG30164 | SG30165 | SG30166 |
| Características | EMBRAGUE HSQ | EMBRAGUE HSQ | EMBRAGUE HSQ |
| Modelos | 503 70 15-02, 503 70 15-01 281, 288, 394, 395 | 537 10 34-01 357, 359 | 503 17 31-01, 503 17 31-02 40, 45 |

| | STL | STL | STL |
|------------------------|--|--|---|
| |  |  |  |
| Referencia | SG30168 | SG30169 | SG30170 |
| Características | EMBRAGUE STL | EMBRAGUE STL | EMBRAGUE STL |
| Modelos | 1123-160-2050 017, 018, 019T, 021, 023, 025, MS170, MS180, MS190T, MS191T, MS210, MS230, MS250 | 1121-160-2051 024, 026, MS240, MS260, MS270, MS280 | 1127-160-2051 029, 034, 039, 390, 340, MS290, MS310, MS390, MS340 |

| | STL | STL | STL |
|------------------------|--|---|--|
| |  |  |  |
| Referencia | SG30171 | SG30172 | SG30173 |
| Características | EMBRAGUE STL | EMBRAGUE STL | EMBRAGUE STL |
| Modelos | 1125-165-2052 036, MS360 | 1119-162-0800 038, MS380 | 1128-160-2004 044, 046, MS341, MS361, MS440, MS460 |

| | STL | STL | STL |
|------------------------|---|--|---|
| |  |  |  |
| Referencia | SG30288 | SG30289 | SG30290 |
| Características | EMBRAGUE STL | EMBRAGUE STL | EMBRAGUE STL |
| Modelos | 4130-160-2000 FS36, FS40, FS44 | 4126-160-2001 FS60, FS61, FS66, FS80, FS81, FS86, FS88 | 4119-160-2000, 4119-160-2001 FS160, FS180, FS220, FS280 |

| | STL | STL | STL |
|------------------------|---|--|---|
| |  |  |  |
| Referencia | SG30509 | SG30649 | SG30650 |
| Características | TORNILLO REGLAJE CABLE | EMBRAGUE STL | EMBRAGUE STL |
| Modelos | | EMBRAGUE STL PARA 017, 018, 019T, 021, 023, 025, MS170, MS180, MS190T, MS191T, MS210, MS230, MS231, MS250 . REEMPLAZA A: 1123-160-2050 | EMBRAGUE STL FS120, FS200, FS240, FS250, FS260, FS300, FS310, FS350, FS360, FS400, FS410, FS450, FS460, FS480, FR410, FR450, FR460, FR480, BT120C, BT121, HT250. REEMPLAZA A 4128-160-2001. |

| | STL | HND | SPORTGARDEN |
|------------------------|---|---|---|
| |  |  |  |
| Referencia | SG31358 | SGXG25-63 | GBC4352N37 |
| Características | EMBRAGUE | EMBRAGUE | MUELLE EMBRAGUE GBC |
| Modelos | EMBRAGUE ELECTROMAGNETICO CSTLGDN, STG & VKNG - H: 90mm, Ø int: 25,4mm, Ø: pulley 133mm. RESISTENCIA: 3.5 Ohm. REEMPLAZA ORIGINAL: 1136-0048-01, 118399062/0, 18399060/0 (Warner 5217-20, 5217-38), 6170-160-2010. | | EMBRAGUE GX25 |

ESCAPES

| | KAW | HND | HND |
|------------------------|--|---|--|
| |  |  |  |
| Referencia | 490692454 | 140FA.9 | 140FA-18 |
| Características | ESCAPE TJ053E-AS50 | ESCAPE | TAPA ESCAPE GX35 |
| Modelos | | GX35 COPIA | 503 86 27-03 340, 345, 346, 350, 353 |

| | HSQ | HSQ | HSQ |
|------------------------|---|---|---|
| |  |  |  |
| Referencia | SG30238 | SG30239 | SG30240 |
| Características | ESCAPE HSQ | ESCAPE HSQ | ESCAPE HSQ |
| Modelos | 503 86 27-03 340, 345, 346, 350, 353 | 365, 371, 372. REEMPLAZA ORIGINAL: 503 76 53 01 | 503 06 94-15 136, 141 |

| | HSQ | HSQ | HSQ |
|------------------------|---|--|---|
| |  |  |  |
| Referencia | SG30241 | SG30242 | SG30243 |
| Características | ESCAPE HSQ | ESCAPE HSQ | ESCAPE HSQ |
| Modelos | 501 76 66-02 51, 55 | 357, 359 503 91 75-01 | 281, 288 501 81 68-01; 501 81 68-02 |

| | HSQ | STL | STL |
|------------------------|--|--|---|
| |  |  |  |
| Referencia | SG30244 | SG30245 | SG30246 |
| Características | ESCAPE HSQ | ESCAPE STL | ESCAPE STL |
| Modelos | 61, 266, 268, 272 501 81 59-01; 503 47 69-01; 501 65 77-01; 503 40 64-02; 725 53 70-55 | 1121-140-0604 024, 026, MS240, MS260 | 1125-140-0607 034, 036, MS340, MS360 |

| | STL | STL | STL |
|------------------------|---|--|---|
| |  |  |  |
| Referencia | SG30247 | SG30249 | SG30250 |
| Características | ESCAPE STL | ESCAPE STL | ESCAPE STL |
| Modelos | 1135-140-0605 MS361 | 018, MS180 1130-140-0600 | 1125-140-0604 023, 025, MS230, MS250 |

| | STL | STL | STL |
|------------------------|---|--|---|
| |  |  |  |
| Referencia | SG30251 | SG30253 | SG30254 |
| Características | ESCAPE STL | ESCAPE STL | ESCAPE STL |
| Modelos | 038, MS380 1115-404-3400 | MS381 1119-140-0607 | 1125-140-0607 034, 036, MS340, MS360 |

| | STL | STL | HND |
|------------------------|---|---|---|
| |  |  |  |
| Referencia | SG30255 | SG30256 | SGXG25-26 |
| Características | ESCAPE STL | ESCAPE STL | ESCAPE |
| Modelos | 1122-140-0614 066, MS650, MS660 | 1127-140-0601 029, 039, MS290, MS310, MS390 | ESCAPE GX25 |

FILTROS DE AIRE

| | BS | HND | BS | SPORTGARDEN |
|------------------------|--|---|----|--|
| |  |  | |  |
| Referencia | SG30007 | SG30012 | | SG30017 |
| Características | FILTRO AIRE BS/HND | FILTRO AIRE BS 3-3.5HP | | FILTRO AIRE GXV160 |
| Modelos | REFERENCIA ORIGINAL HND: 17211-ZL8-000 REFERENCIA ORIGINAL BS: 491588 / 399959 | SPRINT & CLASSIC REFERENCIA ORIGINAL: 272235 | | REFERENCIA ORIGINAL HND: 17210-ZE7-013 |

| | SPORTGARDEN | SPORTGARDEN | STL |
|------------------------|---|---|---|
| |  |  |  |
| Referencia | SG30019 | SG30021 | SG300404 |
| Características | FILTRO AIRE GX110/120/140/160/200 | FILTRO AIRE GX240/270 | FILTRO AIRE |
| Modelos | REFERENCIA ORIGINAL HND: 17210-ZE1-822 | REFERENCIA ORIGINAL HND: 17210-ZE2-822 | Filtro de aire STL para 026 PRO (1121-120-1612) |

| | STL | HSQ | HSQ |
|-------------------|--|--|--|
| |  |  |  |
| Referencia | SG300405 | SG300406 | SG300407 |
| Modelos | Filtro de aire para STL 044, MS440, 046, 064, MS460, MS650, 066, MS660, MS441, MS441C y MS680 - Longitud: 104mm, Ancho: 79mm, H: 43mm (0000-120-1653, 0000-120-1654) | Filtro de aire para HUSQ 36, 41, 136, 136LE, 137, 137E, 141, 141LE, 142 (530-02-98-11) | Filtro de aire para HUSQ 262, 268, 272 y 394 - Longitud: 91mm, Ancho: 65mm, H: 33mm (503-44-72-03) |

| | HSQ | HSQ | HSQ |
|-------------------|--|--|--|
| |  |  |  |
| Referencia | SG300411 | SG300412 | SG300413 |
| Modelos | Filtro de aire para HUSQ 51 y 55 - Longitud: 115mm, Ancho: 89mm, H: 63mm (503-89-8101) | Filtro de aire para HUSQ (505126306) FILTRO DE AIRE HSQ MODELOS 555, 560XP, CS2258, CS2260. REEMPLAZA 505 12 63-03, 505 12 63-06 | Filtro de aire para HUSQ (537 20 75-01) |

| | HSQ | ECH | ECH |
|-------------------|---|--|---|
| |  |  |  |
| Referencia | SG300414 | SG300415 | SG300416 |
| Modelos | Filtro de aire para HUSQ 61, 66, 266, 281 y 288 (501-80-71-01) | Filtro de aire para ECH (130310-39131). ECH CS-3000 - CS-3400, CS-3450, CS-340 | Filtro de aire para ECH (A226-000290). ECH CS-350T |

| | ECH | ECH | STL |
|-------------------|---|---|--|
| |  |  |  |
| Referencia | SG300417 | SG300418 | SG300421 |
| Modelos | Filtro de aire ECH CS440, CS450, CS510, CS520, CS530, CS4400 - H: 35mm, Ø ext: 64mm, Ø int: 45mm (130310-38331) | Filtro de aire ECH PAS2400, PB24LN, PAS2601, PE260, SRM2400, SRM2601, SRM2605, 3100, ES231, HCA2400, 261 y LST2400 - L: 75/80mm, w: 78mm - H: 10mm (130-310-5183-0) | Filtro de aire STL 4140-124-2800 FC55, FS38, FS45, FS45 C, FS45, FS46, FS46 C, FS55, FS55 C, FS55R, FS55RR, FS55T, FS55CT, HL45, HS45, KM55, KM55C, KM55R, KM44 RC |



| | | | |
|-------------------|--|--|---|
| Referencia | SG300422 | SG300423 | SG300424 |
| Modelos | Prefiltro para STL (4119-120-1600) 4109929 | Filtro de aire STL FC100, FC110, FC90, FC95, FR130, FR130T, FS90R, FS100, FS100ARX, FS110, FS130, FS310, FS87, FS90, FT100, FX130, HL100, HL90, HL90K, HL95, HL95K, HT100, HL100K, HT101, HT130, HT131, KM100, KM110, KM130, KM130R, KM90, SP90, SP90T (4180-120-1800) | Filtro de aire STL FS240C, FS240RC, FS260C, FS260RC, FS360C, FS410C, FS460C y FS460RC (4147-141-0300) |



| | | | |
|-------------------|---|--|--|
| Referencia | SG300428 | SG300429 | SG300430 |
| Modelos | Filtro aire ECH PB-760 LHNH, PB-760 LNH, PB-760 LNT, PB-770 H, PB-770 T. (A226-000410, A226-000600) | Prefiltro para filtro de aire 4109919. ECH PB-760 LHNH, PB-760 LNH, PB-760 LNT, PB-770 H, PB-770 T (A226-000480) | Filtro de aire ECH ES-255ES, PB-251, PB-255ES, PB-265ESLT, PPF-300ES, PPT-300ES, SRM-300ES (A226-000350, A226-000470 y A226000471) |



| | | | |
|------------------------|---------------------------|----------------------------|----------------------------|
| Referencia | SG30051 | SG30302 | SG30303 |
| Características | FILTRO DE AIRE GX 340/390 | FILTRO AIRE COMPATIBLE HSQ | FILTRO AIRE COMPATIBLE HSQ |
| Modelos | 235R 502-19-86-02 | 240R-245R 502-11-58-01 | 325R 537-18-63-01 |

| | HSQ | KAW | KAW |
|------------------------|---|--|---|
| |  |  |  |
| Referencia | SG30304 | SG30305 | SG30306 |
| Características | FILTRO DE AIRE COMPATIBLE HSQ | FILTRO DE AIRE ADAPTABLE KAW | FILTRO AIRE COMPATIBLE CON KAW |
| Modelos | 325R 537-18-63-01 | FILTRO DE AIRE KAWASAKI TD18, TF22, TG18, TH43, TH48 Y M48 - L: 58mm, w: 45mm, H: 10mm. REEMPLAZA ORIGINAL: 11013-2081 | - TJ45E |

| | STL | STL | STL |
|------------------------|--|---|--|
| |  |  |  |
| Referencia | SG30308 | SG30309 | SG30310 |
| Características | FILTRO AIRE COMPATIBLE STL | FILTRO AIRE COMPATIBLE CON STL | FILTRO AIRE COMPATIBLE STL |
| Modelos | 4134-141-0300A FS200/250/350/400/450/480 | 4203-141-0301A BR420 | 4282-141-0300 BR600 |

| | STL | STL | STL |
|------------------------|---|--|---|
| |  |  |  |
| Referencia | SG30311 | SG30312 | SG30313 |
| Características | FILTRO AIRE COMPATIBLE STL | FILTRO AIRE COMPATIBLE STL | FILTRO AIRE COMPATIBLE STL |
| Modelos | FILTRO DE AIRE STL 023, MS210, MS230, MS250 Y MS310 - L: 92mm, w: 30mm, H: 33mm. REEMPLAZA: 1123-120-1613 | 038/038S/MS380/051 1119-120-1611 | FILTRO DE AIRE STL 017, 018, MS170 Y MS180. REEMPLAZA 1130-124-0800 |

| | STL | STL | STL |
|------------------------|--|--|---|
| |  |  |  |
| Referencia | SG30314 | SG30315 | SG30316 |
| Características | FILTRO AIRE COMPATIBLE STL | FILTRO AIRE COMPATIBLE STL | FILTRO AIRE COMPATIBLE STL |
| Modelos | FILTRO DE AIRE STL FS48, FS52, FS56, FS62 Y FS66 - L: 64mm, w: 54/46mm, H: 12mm. REEMPLAZA: 4123-124-0800, 4123-124-0801 | FILTRO DE AIRE STL 024, 026, MS240 Y MS260 - L: 98mm, w: 78mm, H: 44mm. REEMPLAZA: 1121-120-1617 | 1118-120-1610; 1118-120-1611; 1118-120-1615 028/028 SUPER |

| | STL | STL | STL |
|------------------------|--|--|---|
| |  |  |  |
| Referencia | SG30317 | SG30318 | SG30319 |
| Características | FILTRO AIRE COMPATIBLE STL | FILTRO AIRE COMPATIBLE STL | FILTRO AIRE COMPATIBLE STL |
| Modelos | 1119-120-1611; 1119-120-1610; 1119-120-1615 038/MS038/051 | FILTRO DE AIRE STL MS290, MS310, MS390 Y 029 CON Intelli Carbet - L: 117mm, w: 38mm, H: 66mm. REEMPLAZA: 1127-120-1621 | 4119-141-0300 FS160/180/220/280/290 |

| | HND | HND | HND |
|------------------------|--|--|---|
| |  |  |  |
| Referencia | SG30320 | SG30321 | SG30322 |
| Características | FILTRO AIRE COMPATIBLE HND | FILTRO AIRE COMPATIBLE HND | FILTRO AIRE COMPATIBLE HND |
| Modelos | FILTRO CON CARCASA HND GX240, GX270. Replaces original 17231-ZH9-820, 17235-Z52-820. | FILTRO DE AIRE COMPLETO HND GX240, GX270. REEMPLAZA 17231-ZH9-820, 17235-Z52-820. | 17210-ZE8-013 GXV 270/340/390 |

| | HND | HND | HND |
|------------------------|---|--|---|
| |  |  |  |
| Referencia | SG30369 | SG30492 | SG30493 |
| Características | FILTRO CON TAPA EN BAÑO DE ACEITE | FILTRO AIRE COMPATIBLE HND | FILTRO AIRE BS 7-8-9-10-13-15-16 HP HORIZ |
| Modelos | REFERENCIA ORIGINAL HNDGX160: 17231-ZE1-000 | GX240/GX270 17231-ZH9-820 | FILTRO SUSTITUYE ORIG. 3939/57/390930 |

| | SPORTGARDEN |
|------------------------|--|
| |  |
| Referencia | SG30543 |
| Características | FILTRO AIRE |
| Modelos | FILTRO DE AIRE STL BR320, BR320L, BR400, SR320 & SR400. REEMPLAZA: 4203-141-0300. H: 38mm, Ø ext: 73mm, Ø int: 46mm. |

| | STL | STL | STL |
|------------------------|---|--|---|
| |  |  |  |
| Referencia | SG30637 | SG30638 | SG30639 |
| Características | FILTRO DE AIRE STL MS192T, MS192TC. REEMPLAZA: 1137 120 1600. | FFILTRO DE AIRE STL 020 and 020T (series 1129), MS200, MS200T. REEMPLAZA: 1129 120 1607. | FILTRO DE AIRE STL MS201, MS201T. REEMPLAZA 1145-140-4400. |

ECH **KAW**



| | | |
|------------------------|---|--|
| Referencia | SG30810 | SG31317 |
| Características | FILTRO AIRE ECH | FILTRO AIRE KW |
| Modelos | FILTRO DE AIRE ECH PB403, PB413, PB 603, PB611 Y PB 650 - L: 105mm, w: 67mm - H: 35mm. REEMPLAZA: A226-000-031 Y A226-000-032 | FILTRO DE AIRE KW TJ53. REEMPLAZA: 11013-2242. |

KAW **SPORTGARDEN**



| | | |
|------------------------|---|----------------------|
| Referencia | SG31318 | SGXG25-46 |
| Características | FILTRO AIRE KW | FILTRO AIRE COMPLETO |
| Modelos | FILTRO DE AIRE KW KRB750 Y TK065. REEMPLAZA 11029-0015, 11029-2021. | GX25 |

FILTROS DE GASOLINA

HND **SPORTGARDEN** **SPORTGARDEN**



| | | | |
|------------------------|-----------------------------------|--|---|
| Referencia | SG30004 | SG30457 | SG30458 |
| Características | FILTRO GASOLINA EXT. HND SERIE GX | FILTRO GASOLINA | FILTRO GASOLINA |
| Modelos | REF.ORIGINAL 16955-ZE1-000 | Husq, Poln, Jonsrds (503443201); Plástico poroso; Sirve para tubo de gasolina de 4,0mm | Zama (ZF-2); Sirve para tubo de gasolina de 4,8mm |

| | HND | SPORTGARDEN | SPORTGARDEN |
|------------------------|--|--|--|
| |  |  |  |
| Referencia | SG30459 | SG30460 | SG30461 |
| Características | FILTRO GASOLINA | FILTRO GASOLINA | FILTRO GASOLINA |
| Modelos | Walbr (125-528-1); para motores de más de 80cc; doble filtración, sirve para tubo de gasolina de 4,8 | Walbr (125-527-1); Para motores de más de 30cc; doble filtracion, sirve para tubo de gasolina de 4,8mm | Hmit (49422); McClich (216985); Tecmsh (410245); Zm (ZF-1); Sirve para tubo de gasolina de 3,2mm |

| | SPORTGARDEN | SPORTGARDEN | SPORTGARDEN |
|------------------------|--|---|--|
| |  |  |  |
| Referencia | SG30462 | SG30463 | SG30464 |
| Características | FILTRO GASOLINA | FILTRO GASOLINA | FILTRO GASOLINA |
| Modelos | Zama (ZF-4); Sirve para tubo de gasolina de 4,8mm | Zama (ZF-5); Sirve para tubo de 6,3mm | Sirve para tubo de gasolina de 6,3mm; Compatible con E85; Diámetro 1,6" |

| | HND |
|------------------------|---|
| |  |
| Referencia | SG30003 |
| Características | FILTRO DE GASOLINA HND |
| Modelos | REF. ORIGINAL HND: 16762-880-000 |

SPORTGARDEN

SPORTGARDEN



| | | |
|------------------------|---------------------------|---------------------|
| Referencia | SG31050 | SG31352 |
| Características | FILTRO DEPOSITO INF GX160 | FILTRO GASOLINA WLB |

INTERRUPTORES

SPORTGARDEN

SPORTGARDEN



| | | |
|------------------------|------------------|------------------|
| Referencia | SG30528 | SG30577 |
| Características | INTERRUPTOR PARO | INTERRUPTOR UNIV |

JUNTAS

KAW

HND

HND



| | | | |
|------------------------|----------------------------|-----------------|-----------------|
| Referencia | 110612234 | 140FA-15 | 140FA-19 |
| Características | JUNTA CILINDRO TJ053E-AS50 | JUNTA TORICA | JUNTA GOMA |
| Modelos | | GX35 COPIA | GX35 COPIA |

HND



HND

HND

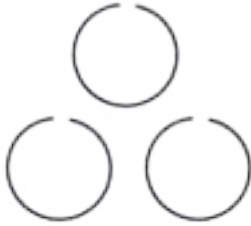

| | | | |
|------------------------|----------------|----------------|----------------|
| Referencia | 140FA-2 | 140FA-5 | 140FA-7 |
| Características | JUNTA ESCAPE | JUNTA | JUNTA ADMISIÓN |
| Modelos | GX35 COPIA | GX35 COPIA | GX35 COPIA |

KIT DE AROS

| | HND | HND |
|------------------------|---|--|
| |  |  |
| Referencia | 140FA.3.2 | SG30500 |
| Características | KIT DE AROS | KIT AROS COMPATIBLE GX390 |
| Modelos | GX35 COPIA | |

KIT DE CILINDROS



| | SPORTGARDEN | ECH | STL |
|------------------------|--|---|--|
| |  |  |  |
| Referencia | CG520-03 | SG30655 | SG30660 |
| Características | | KIT CILINDRO ECH | KIT CILINDRO STL |
| Modelos | MAXIMA 52 44MM | REEMPLAZA P021009250 | KIT CILINDRO STL FS400, FS400-K, FS400-L, SP400. REEMPLAZA 4128-020-1201. |

| | STL | STL | STL |
|------------------------|---|--|---|
| |  |  |  |
| Referencia | SG30661 | SG30663 | SG30665 |
| Características | KIT CILINDRO STL | KIT CILINDRO STL | KIT CILINDRO STL |
| Modelos | KIT CILINDRO Ø 42mm STL FR450 Y FS450. REEMPLAZA: 41280201211 | KIT CILINDRO Ø 44mm STL FR480. REEMPLAZA: 41280201202 | KIT CILINDRO Ø 40 mm STL MS211. REEMPLAZA: 1139-020-1202. |

| | STL | STL | STL |
|------------------------|---|--|---|
| |  |  |  |
| Referencia | SG30666 | SG30667 | SG31187 |
| Características | KIT CILINDRO STL | KIT CILINDRO STL | KIT CILINDRO STL |
| Modelos | KIT CILINDRO Ø: 40mm STL MS200 Y MS200T. REEMPLAZA: 1129-020-1202 | KIT CILINDRO Ø 40 mm STL MS201 & MS201T. REEMPLAZA: 1145-020-1200. | KIT CILINDRO Ø 38mm STL MS180, MS180C Y 018. REEMPLAZA: 11300201208, 11300201209 |

| | STL | STL |
|------------------------|---|--|
| |  |  |
| Referencia | SG31189 | SG31207 |
| Características | KIT CILINDRO STL | KIT CILINDRO STL |
| Modelos | KIT CILINDRO Ø 37 mm STL MS192T. REEMPLAZA: 1137-020-1201. | KIT CILINDRO ø 46mm STL BR320, BR320L, BR340, BR340L, BR380, BR400, BR420, BR420C, SR320, SR340, SR400, SR420. REEMPLAZA 4203-020-1201. |

MEMBRANAS

| | SPORTGARDEN | SPORTGARDEN | SPORTGARDEN |
|------------------------|--|---|--|
| |  |  |  |
| Referencia | SG30370 | SG30371 | SG30372 |
| Características | KIT JUNTAS CARBURADOR | KIT JUNTAS CARBURADOR | KIT JUNTAS CARBURADOR |
| Modelos | Conjunto de junta y diafragma NIK para MITS T110, T140 ,T180, T200, SNAPPER 210SST, 211ST, 2400SS, 2450, TORO TC1000, 3000, 3500, 4000, 5000 y TAS MARYM | HK; Alpñ 56/66/700/800; Stl 032AV/038/038AV; Jnsrd 410/450/525/535; Dlmr 112/117; Wckr BH23; Opm 145/155/165 | HS; Husq 61/261/266/268; Stl TS400/ TS460/TS510/TS760/041AV/050/051/ TS510/056AV/088 |

SPORTGARDEN



| | | | |
|------------------------|--|---|--|
| Referencia | SG30373 | SG30374 | SG30377 |
| Características | KIT JUNTAS CARBURADOR | KIT JUNTAS CARBURADOR | KIT JUNTAS CARBURADOR |
| Modelo | HL; Stl 08/070/TS350/TS08; Ech CLS80/CSL100; Hmlt XP1000/XP1020/SX1020/XP1100/XP1130/SXP1130/2000AU-T0/2100/2100S/4-20/5-63/6-663/14L/5-20L/6-22/7-19/21/63/9-23/26/500/500MO-D/600D/660D/700/707/900/990D/995/C5/C7/C9/C51/C52/C71/C72/C91/Super 2000/3100g; Prtnr 650/S650/600/610/620/450/550; Pol-n53/53A/54/568/71/71A/72/S72 | HS; Husq 61/65/160/165/170/180/260/280/281/285/380/480/2100; Jnsrd 50/52E/62/66E/70E/80/90/100/601/621/625/630/670/801/820/920; Olemc 234/244/335/340/390/940/246/251/254/271/481/482/492/950; Hmlt XL12/SXL12 auto; Dlmr 119/122/123/309/133/144/153/310; McCilch 10/SP60/670/SP105/125/710A | HU; Husq 36R/140R/244R/Husky34/35; Jnsrd 361/40; Stl 020/028/024/026AV; Poln micro XXV; Olemc 940/234; McCilch Super Mac 38; Partnr Mini P1/P2/P3/330/340/P48/P49; Sol 610/647 |

SPORTGARDEN

SPORTGARDEN

SPORTGARDEN

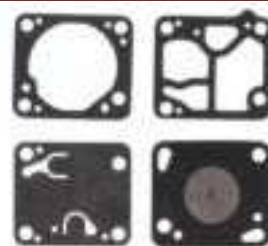

| | | | |
|------------------------|---|---|--|
| Referencia | SG30378 | SG30379 | SG30380 |
| Características | KIT JUNTAS CARBURADOR | KIT JUNTAS CARBURADOR | KIT JUNTAS CARBURADOR |
| Modelos | HU; Alpn A40/PROF45/ Olemc 234/244/355/340/940/940F/ND246; McCilch PM360/370/390AS/470/480; Dlmr 110; Prtnr 330/340/1614/1616; Husq 36R/140R/244R; Jnsrd 40/361; Stl 020AV/024/028AV/030AV; Sol 647 | HDB; McCilch Prmc 610/650/ Power Mac 65; Ech CS500/CS501/CS502/CS650/CS660/CS661; Pln 3400/4000 | MDC; McCilch Mini Mac 6/20/25/30/35/110/120/Promac 155/165 |





SPORTGARDEN



SPORTGARDEN

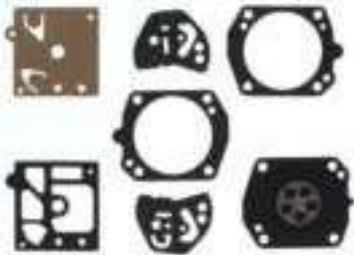

SPORTGARDEN

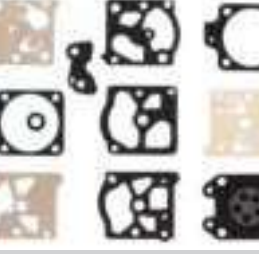



| | | | |
|------------------------|---|--|---|
| Referencia | SG30381 | SG30382 | SG30383 |
| Características | KIT JUNTAS CARBURADOR | KIT JUNTAS CARBURADOR | KIT JUNTAS CARBURADOR |
| Modelos | HD; Husq 371/372XP; Stl 029/039/044/046/MS270/FS360/FS550/BR320/BR400/BR420 | WYL; Ech GT1100/GT2101/GTB1100/GTB2101/CS221/HC1001; Emk/Olemc GDO 26cc; Hnd GX22/GX31/ZM3/ZM3A/M5A; Kawsk TGX23/TH023D; Komts G22L/G23L/G23LH/TR200/XE32; Mrym AE200/AE230/AE49/BE01/BE200/BE201/BE230/CE02/CE230/LE14/LE230; Mitsubishi TL201/TL231; Shndw R220/S200/S220/S230/T2500/XS200/XT2500/DH220/B22F/C230; Tnk AS4501/AST4500/ST2048/ST2050/TBC4000/TBC4500/TBC4501/TC2211/TC2400/TC2501/TC2200/TC2390/TED210/THT210 | WJ; Stl 026; Olemc 350/Super 261G/980; Pio P39; Círl M88/M88BL; Emk 264; Hmlt 540/8800/MP55/MP88; Husq P42T/2077/394/61P/700/A55/F55/F65/P42/P52/P62/P650/P7000/P7700; McCull Mac 511/Mac611/Mac710/Mac950/Mac960/Mac970/MS55/MS60/Titan 51/Titan55/Titan60; Poulan 405/455/525/655/Pro475; Sol 603/670/680/690 |



| | SPORTGARDEN | SPORTGARDEN | SPORTGARDEN |
|------------------------|--|---|--|
| |  |  |  |
| Referencia | SG30384 | SG30385 | SG30386 |
| Características | KIT JUNTAS CARBURADOR | KIT JUNTAS CARBURADOR | KIT JUNTAS CARBURADOR |
| Modelos | HDA, Alpn/Cstr 800; Efc/Olemc 147/1521/156; Ech CS551; Hmlt 350; Husq 42/44/133/154/234/238/242/240RX/245R-X/250RX/254/340/345/346X-P/350/351/357XP/359; Jonsrd 420/435/450/455/520/525/535/2141/2145/2150/2051/RS40/RS45/RS51; Trk TBC422/TEA500; Dlmr 116/120; 116/120; Slo 641/644, | - WYL; Ech GT1100/GT2101/GTB1100/GTB2101/CS221/HC1001; Emak/Oleomac GDO 26cc; HNDGX22/GX31/ZM3/ZM3A/M5A; KAW TGX23/TH023D; Komatsu G22L/G23L/G23LH/TR200/XE32; Maruyama AE200/AE230/AE49/BE01/BE200/BE01/BE230/CE02/CE02/CE230/LE14/LE230; Mitsubishi TL201/TL231; Shindaiwa R220/S200/S220/S230/T2500/XS200/XT2500/DH220/B22F/C230; Tanaka AS4501/AST4500/ST2048/ST2050/TBC4000/TBC4500/TBC4501/TC2211/TC2400/TC2501/TC2200/TC2200/TC2390/TED210/TH210 | WJ; Stl 056; Olmc 350/Super 261G/980; Pioneer P39; Cifarelli M88/M88BL; Emak 264; Hmlt 540/8800/MP55/MP88; Husq P42T/2077/394/61P/700/A55/F55/F65/P42/P52/P650/P7000/P7700; McCil MAC511/MAC611/MAC710/MAC950/MAC960/MAC970/MS55/MS60/Titan 51/Titan 55/Titan 60; Pln 405/455/525/655/PRO475; SI 603/670/680/690 |
| |  |  |  |
| Referencia | SG30387 | SG30389 | SG30390 |
| Características | KIT JUNTAS CARBURADOR | KIT JUNTAS CARBURADOR | KIT JUNTAS CARBURADOR |
| Modelos | SDC; Ech CS702/CS750/CS900; Homelite 550XLA0/SXL925; McCulloch Promac 700/B1/B2/8200/PM10-10; Pioneer P50/60/51/52/62 | WS; Prtnr S50/F55/F65/P7000/K1200; Stl 051/076 | WAWT; Omac740; Efc 8400/931/935/936/940/140C/136/140; Alpn/CSTR Vip 51/25/30/34/42/52; Homlt ST155/185/385/CS240/290/340; Tanaka ECV4501/TCS3401; Husq 225R/232R/235R/36/136/41/141/137/142; Ech SRM3100/3400/CS2600/3400/4000/5100; Znh G33 |



| | SPORTGARDEN | SPORTGARDEN | SPORTGARDEN |
|------------------------|---|---|--|
| |  |  |  |
| Referencia | SG30391 | SG30392 | SG30393 |
| Características | KIT JUNTAS CARBURADOR | KIT JUNTAS CARBURADOR | KIT JUNTAS CARBURADOR |
| Modelos | HD; Husq 133/371/372XP; Stl 029/039/044/046/FS360/FS500/FS550/MS390/BR320/BR400/MS270; Pionr P39; ECH SRM3100/3400/CS2600/4000/5100 | WYJ; Husq 142; Olmc/Efc 725F; Kz/Mitsbsh VS250/TL26/VS2507/TL20VS/220/TL20/Kw TH34; Tnk TBC2000/220/221/240250/TBC4110/440/5000 | COMPATIBLE CON wa - wt & wta Stl 09/010/011/015/017/02/FS40/FS44/FS85/FS86/FS88/FS1600/FS160; Husq 40/51/55/26LC/225R/232R/235R/240/244R/245R/39R/240RBD/Mnd 225R/36/136/41/141/137/142; Jnsrd 365/370/2036/2040/GT21/GT22/GT24/GR36/GR32; Alpn/Cstr 330/PB34/VIP21/25/30/34/42/52; Ech CS302/CS3450/HC210/PB201E/PB400/SRM3100/3400/CS2600/4000/5100; Hmit 26LC/240/PBC3800/ST155/185/385/CS240/290/340; McCull 4600/4700/PRO-MAC3/TD4100; Olmc935/951/233/240/Jet40/936/740; Efc 136/8400/931/935/936/940/140C/136/140; Prtnr 330/P500/K500; Shndw 360/405/415/450/F20XE405AT/E305V; Dlmr 100/102/103/105/108/109/110/111/115/300/400/BC210/212/LT210/LT250/SD100/BC330/BC400; Tnk ECV4501/TCS3401 |



| | SPORTGARDEN | SPORTGARDEN | SPORTGARDEN |
|------------------------|---|--|--|
| |  |  |  |
| Referencia | SG30394 | SG30395 | SG30396 |
| Características | KIT JUNTAS CARBURADOR | KIT JUNTAS CARBURADOR | KIT JUNTAS CARBURADOR |
| Modelos | WA/WT; Stl 09/010/011/015/017/028/FS40/44/85/86/88/160; Husq 40/51/55/26LC/235R/240/244R/245R/39R/240RBD/Mondo225R; Jnsrd 365/370/2036/2040/GT21/GT22/GT24/GR36/32; Alpn/Cstr 330/PB34; Ech CS302/CS450/HC210/PB201E/PB400/SRM4600/4605; Homit 26LC/240/PBC3800; McCilch 4600/4700/Promac3/TD4100; Olmc 935/951/233/240/Jet40/936; Efc136; Prtnr 330/P500/K500; Shndw 360/405/415/450/F20X/E405AT/E305AV; Dlmr 100/102/103/105/108/109/110/111/115/300/400/BC210/LT210/LT250/BC330/BC400, | K20-HDA | WA/WT; McCilch 4600/4700/4900/PM3/TD4100; Omac/Efc 233/240/953/Jet400; Husq 50R/26LC/232R/235R/240RBD/Mondo 225LD/ Poulan 1800/200/2300/PRO111; Stl 09/010/011/028/FS40/FS44/FS85/FS86/FS88/FS106/FS180; Alpn/CSTR 330/380/P34; Ech CS302/HC210/PB210E/PB4000/SRM4600/4605; Shind 305/345/405/415/450/500/575/F20/XE405AT/E305AV |



| | SPORTGARDEN | SPORTGARDEN | SPORTGARDEN |
|------------------------|---|---|---|
| |  |  |  |
| Referencia | SG30397 | SG30398 | SG30399 |
| Características | KIT JUNTAS CARBURADOR | KIT JUNTAS CARBURADOR | KIT JUNTAS CARBURADOR |
| Modelos | Kit reparación para walbro. Reemplaza k10-sdc. | WJ; Husq 372XP; Olmc/Efc 181/971/981; Stl 064/066/066Mangum | SDC; McCulloch Promarc 700/8200/PM10-10; Homelite Super XLA0/550/SXL928; ECH CS702/CS750EVL/CS900EVL; Pioneer P40/P42/950/P51/P52/P61/P62 |

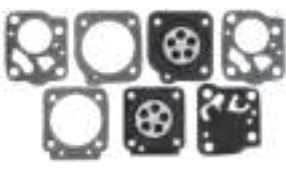

| | SPORTGARDEN | SPORTGARDEN | SPORTGARDEN |
|------------------------|---|---|---|
| |  |  |  |
| Referencia | SG30400 | SG30401 | SG30402 |
| Características | KIT JUNTAS CARBURADOR | KIT JUNTAS CARBURADOR | KIT JUNTAS CARBURADOR |
| Modelos | C1U; ECH SRM2100/SMR2110/SRS2100/TT21A/ES2000/PB1000/PB1010/ES1000/AT200G/GT1100/GT2000/PE2000/SRM1501/SRM2300/GT2100/HT1600/2000 | HDB; Pln PRO 285/335/375/395/3400/3700/3800; McCulloch Prmc 610/650 | WA; WT; McCulloch 4600/4700/4900/PM3/TD4100; Olmc/Ef 233/240/935/ Jet400; Husq 50R/26L-C/232R/235R/240RBD/Mondo225LD; Pln 1800/200/2300/PRO205/185/235/S25 DA/2050/2150/2450/505/2500/2900/050/PRO111; Stl 09/010/011/028/FS40/FS44/FS85/FS86/FS88/FS106/FS180; Alpn/Cstr 330/380/P34; Ech CS302/HC210/PB210E/PB4000/SRM4600/4605; Shndw 305/345/405/415/450/500/575/F20/XE405AT/E305AV |



| | SPORTGARDEN | SPORTGARDEN | SPORTGARDEN |
|------------------------|---|---|---|
| |  |  |  |
| Referencia | SG30403 | SG30404 | SG30405 |
| Características | KIT JUNTAS CARBURADOR | KIT JUNTAS CARBURADOR | KIT JUNTAS CARBURADOR |
| Modelos | C1S; Stl FS106/220/280/300/09/010/011/012; ECH ES2000 | C1U; Ech HC1500/SV4/SRM3800/HC1600/HC2000/HC2100/HC2300/J21/D21C/J21S/D21S/GT2103/JD30S/HC1500/HC2000/HC2400/SRM2301/SRM2310/SRM3000/SRM2501S/SRM2510/SRM3000/J30S/D30S | C3A; Stl 034/036/044/MS340/MS360 |



| | SPORTGARDEN | SPORTGARDEN | SPORTGARDEN |
|------------------------|---|--|---|
| |  |  |  |
| Referencia | SG30406 | SG30407 | SG30408 |
| Características | KIT JUNTAS CARBURADOR | KIT JUNTAS CARBURADOR | KIT JUNTAS CARBURADOR |
| Modelos | C1Q/C1M/C1S/C1U/LE/RB; Ech 280E/EVLP | C1U; Hmit ST155/175/185/385/385/285; McCulloch 28cc/32cc | C3M; Stl 044/MS440 |



| | SPORTGARDEN | SPORTGARDEN | SPORTGARDEN |
|------------------------|---|--|---|
| |  |  |  |
| Referencia | SG30409 | SG30410 | SG30411 |
| Características | KIT JUNTAS CARBURADOR | KIT JUNTAS CARBURADOR | KIT JUNTAS CARBURADOR |
| Modelos | C1; McCllch PM310/PM510X | C1U; McCllch Mac60/Mac80; Snppr P212/P213/P215 | C1Q; Stl 020T/021/023/025 |

| | SPORTGARDEN | SPORTGARDEN | SPORTGARDEN |
|------------------------|---|--|---|
| |  |  |  |
| Referencia | SG30412 | SG30413 | SG30414 |
| Características | KIT JUNTAS CARBURADOR | KIT JUNTAS CARBURADOR | KIT JUNTAS CARBURADOR |
| Modelos | C1S; Hmit 240/245/330; Oleomac Jet 460/300/400; ECH CS330EVLP | C1S; Stl FS106/220/280/300/09/010/011/012; ECH ES2000 | C1M; Ech PB4600/PB6000 |

| | SPORTGARDEN | SPORTGARDEN | SPORTGARDEN |
|------------------------|---|--|---|
| |  |  |  |
| Referencia | SG30415 | SG30416 | SG30417 |
| Características | KIT JUNTAS CARBURADOR | KIT JUNTAS CARBURADOR | KIT JUNTAS CARBURADOR |
| Modelos | C3M; Stl 034 Super/036/036 PRO | C1U; Hmit ST155/175/185/385/285; McCulloch 28cc/32cc; Weed Eater hedgetrimmer | C1U; Ech HC1000/SRH040/PB1000/1010/GT2103/SRM1501/2600/WP1000/ES2000; McCulloch 60/80 |

| | SPORTGARDEN | SPORTGARDEN | SPORTGARDEN |
|------------------------|---|--|---|
| |  |  |  |
| Referencia | SG30418 | SG30419 | SG30420 |
| Características | KIT JUNTAS CARBURADOR | KIT JUNTAS CARBURADOR | KIT JUNTAS CARBURADOR |
| Modelos | HL; C1M; Husq 445/445E/450/450E/H365BF/Soplador BP | C1Q; Stl 009/010/011/012/020T/021/023/025/FR108/BR106/FS38/FS45/FS55/FS108; Dlmr PS34/PS340/341/342/343/PS3; Husq 137/142/40/45/125L; Ech CS280; Hmlt HT17/HT17/HT21 | C3A; Stl 034/034 Super/MS360/036 |

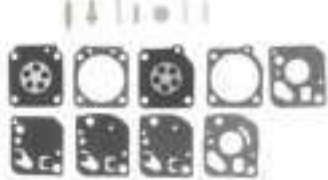
| | SPORTGARDEN | SPORTGARDEN | SPORTGARDEN |
|------------------------|---|---|--|
| |  |  |  |
| Referencia | SG30421 | SG30422 | SG30423 |
| Características | KIT JUNTAS CARBURADOR | KIT JUNTAS CARBURADOR | KIT JUNTAS CARBURADOR |
| Modelos | C1Q/C1U; Ech SRM3550; Shibr SD23/SD26/SD35/SD45 | C1Q/C3; Hmlt HBC38/40/XL/Super 2; Husq 137/142/235; McCllch 730/735/740/MC4-5; Olemc 935; Puln Super 25P600 | C1Q; Stl FS75/85/85R/SP81/MS261/MS271/MS291/FS38/FS55(modelo nuevo)/FS450 |

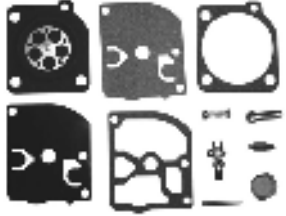
| | SPORTGARDEN | SPORTGARDEN | SPORTGARDEN |
|------------------------|---|---|---|
| |  |  |  |
| Referencia | SG30424 | SG30426 | SG30427 |
| Características | KIT JUNTAS CARBURADOR | KIT JUNTAS CARBURADOR | KIT JUNTAS CARBURADOR |
| Modelos | C1U; Ryo 700/740/780; Homlt ST155/ST175/ST285/ST385 | Kit membranas carburador zam c1q para STL fs450, fs85, fs108, fs106 & bg75. Reemplaza gnd28 | C1Q/Mselite HBC38/HBC40/HBC250/McClch PM3505/3214/3216/3505/3516/3818 |

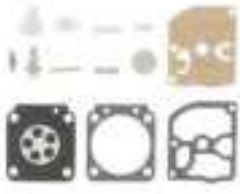
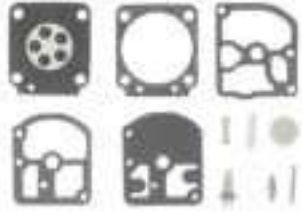
| | SPORTGARDEN | SPORTGARDEN | SPORTGARDEN |
|------------------------|---|---|---|
| |  |  |  |
| Referencia | SG30428 | SG30429 | SG30430 |
| Características | KIT JUNTAS CARBURADOR | KIT JUNTAS CARBURADOR | KIT JUNTAS CARBURADOR |
| Modelos | C1S; McCllch Mac60A/80A | C1Q; Stl 020T/021/023/025 | C1M; Ech PB4600/PB6000 |











| | | | |
|------------------------|---|--|--------------------------------------|
| Referencia | SG30431 | SG30432 | SG30433 |
| Características | KIT JUNTAS CARBURADOR | KIT JUNTAS CARBURADOR | KIT JUNTAS CARBURADOR |
| Modelos | C1U; Ech TC2100/SV4-E/SV4-B/GT251/SRM251/SV5C/TC210 | C1Q; Husq 40/45/51/55/240R/245R-RX; Jonsrd 2050/2045/2041/RS44; Partn 400/410450/460/490/510 | C1Q; Stl 020/020T/MS191/MS192/MS200T |

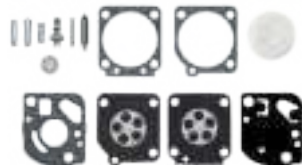

| | | | |
|------------------------|-----------------------|---|--------------------------------------|
| Referencia | SG30434 | SG30435 | SG30436 |
| Características | KIT JUNTAS CARBURADOR | KIT JUNTAS CARBURADOR | KIT JUNTAS CARBURADOR |
| Modelos | C1Q-S118 STL TS420 | C1Q; Stl FH75/FC75/HL75/FS75/FS80/FS85/HT70/HT75/HS75/HS80/HS85/BG75/FS55/FS46/FC55 | C1Q; Stl 020/020T/MS191/MS192/MS200T |



| | | | |
|------------------------|------------------------------|--|--|
| Referencia | SG30437 | SG30438 | SG30439 |
| Características | KIT JUNTAS CARBURADOR | KIT JUNTAS CARBURADOR | KIT JUNTAS CARBURADOR |
| Modelos | C1Q; Stl 017/018/MS170/MS180 | C1Q; Olemc/Efc 750/8510/6408742/Jet400 | C1Q; Stl 021/023/025/MS210/MS230/MS250/FS35/FS55 |

| | SPORTGARDEN | SPORTGARDEN | SPORTGARDEN |
|------------------------|---|---|---|
| |  |  |  |
| Referencia | SG30440 | SG30441 | SG30442 |
| Características | KIT JUNTAS CARBURADOR | KIT JUNTAS CARBURADOR | KIT JUNTAS CARBURADOR |
| Modelos | C1U; ECH RB23/HC1500/SV4 | C1M; Ech PB4600; Hmit 4016/4040/4518/HBC26SJS/F3045; Stl FS55/FS350/FS45; McCilch Cabrio 300; Prtnr Colibri; Husq 322R; | C1U; Shdwa SD23/SD26; Ech RB23/HC1500/SV4 |
| | SPORTGARDEN | SPORTGARDEN | SPORTGARDEN |
| |  |  |  |
| Referencia | SG30443 | SG30444 | SG30445 |
| Características | KIT JUNTAS CARBURADOR | KIT JUNTAS CARBURADOR | KIT JUNTAS CARBURADOR |
| Modelos | C1U; ECH RB125; Poulan VS2/H18-22/HG25-22 | C1U; Ech ES2100/PB2100/ES2400 | C1Q; Stl TS410/TS420 |
| | SPORTGARDEN | SPORTGARDEN | SPORTGARDEN |
| |  |  |  |
| Referencia | SG30446 | SG30447 | SG30490 |
| Características | KIT JUNTAS CARBURADOR | KIT JUNTAS CARBURADOR | KIT JUNTAS CARBURADOR |
| Modelos | C1Q; DImr Serie PS; Husq 136/141/137/142; Stl 019/MS190/021/023/025/026/MS210/MS230/MS250/MS260/FS200/FS250/FS350; McCulloch 730/735/740/Przc 40/46; Ryb y Hmit 30cc. | BS 495770 | KIT DE JUNTAS CARBURADOR ZAMA PARA HSQ H335, H 340, H345, 346XP, 346XPT, 350, 351, 353, JSRD 2141, 2145, 2149, 2150, 2152 & STL 034 Super, 036 & 036 Pro. REEMPLAZA: GND21 & GND54. |

SPORTGARDEN



| | |
|------------------------|----------------|
| Referencia | SG31305 |
| Características | KIT JUNTAS STL |

MOTOR GASOLINA

SPORTGARDEN



| | |
|------------------------|---------------------------------|
| Referencia | 1P65FE |
| Características | MOTOR CORTACESPED 139CC Ø22.2mm |

SPORTGARDEN



| | |
|------------------------|---------------------------------|
| Referencia | 1P70FE |
| Características | MOTOR CORTACESPED 196CC Ø22.2mm |

SPORTGARDEN



| | |
|------------------------|---|
| Referencia | LC2V78FD25.4 |
| Características | MOTOR BICILINDRICO CON CAJA CONTROL Ø25.4mm |

SPORTGARDEN



| | |
|------------------------|---|
| Referencia | LC2V80FD |
| Características | MOTOR BICILINDRICO 764cc CON CAJA CONTROL |

SPORTGARDEN



| | |
|------------------------|--|
| Referencia | LC2V80FDG |
| Características | MOTOR BICILINDRICO 764cc CON CAJA DE CONTROL GENERADOR |

SPORTGARDEN



| | |
|------------------------|-----------------------|
| Referencia | MGSC330 |
| Características | MOTOR COMPLETO GSC330 |

SPORTGARDEN



| | |
|------------------------|-------------------------|
| Referencia | MTT52 |
| Características | MOTOR SPORTGARDEN 52 CC |
| Modelos | |

SPORTGARDEN



| | |
|------------------------|------------------|
| Referencia | MMAXIMA52 |
| Características | MOTOR MAXIMA 52 |
| Modelos | MAXIMA 52 |

SPORTGARDEN



| | |
|------------------------|------------------------------|
| Referencia | SG210001 |
| Características | MOTOR COMPLETO SG-P768K/G |
| Modelos | OS-P768K - OS-P980 - SG P60T |

| | SPORTGARDEN | SPORTGARDEN | KAWASAKI |
|------------------------|---|---|---|
| |  |  |  |
| Referencia | SGXG25 | SGXG35 | TJ045E-KS51M |
| Características | MOTOR 4T | MOTOR 4T | MOTOR KAW TJ045E-KS51M |
| | KAWASAKI | SPORTGARDEN | |
| |  |  | |
| Referencia | TJ053E-AS50M | TT508-64 | |
| Características | MOTOR KAW TJ053E-AS50M | MOTOR SG 508 | |
| Modelos | | - Nº64 TT-BC508-1 | |

MUELLE ACELERADOR

| | HND | HND | HND |
|------------------------|---|--|---|
| |  |  |  |
| Referencia | SG30084 | SG30085 | SG30086 |
| Características | MUELLE ACELERADOR | MUELLE ACELERADOR | MUELLE ACELERADOR |
| Modelos | GX240/GX270/GX340/GX490 16562-ZE2-000 | GX110, GX120, GX140, GX160 16562-ZE1-020 | GX390 16561-ZE3-000 |

| | HND | HND | HND |
|------------------------|---|--|---|
| |  |  |  |
| Referencia | SG30087 | SG30088 | SG31353 |
| Características | MUELLE ACELERADOR | MUELLE ACELERADOR | MUELLE ACELERADOR |
| Modelos | GX110/GX120/GX140/GX 160 16561-ZE1-810 | GCV135/GCV160 16562-ZM0-000 | REF ORIGINAL 16562-ZE3-000 |

MUELLE ARRANQUE

| | KAW | KAW | STL |
|------------------------|---|--|--|
| |  |  |  |
| Referencia | 921450837 | 921450864 | SG30643 |
| Características | MUELLE ARRANQUE TJ053E-/TJ045E-KS51 | MUELLE ARRANQUE TJ053E-AS50 | MUELLE ARRANQUE STL |
| Modelos | | | MUELLE DE ARRANQUE STL 026, 028, 032, 034, FS180, MS240, MS260. REEMPLAZA: 1118-190-0600 |

| | STL | ALPN |
|------------------------|--|---|
| |  |  |
| Referencia | SG30645 | SG31333 |
| Características | MUELLE ARRANQUE STL | MUELLE ARRANQUE ALPN |
| Modelos | MUELLE ARRANQUE STL FS120, FS120R, FS200, FS200R, FS250, FS250R, FS300, FS350, FS450, FS480, FR350, FR450, FR480, FR480C, FT250, HT250, SP200, SP400, SP450, SP451, SP481, BT120C Y BT121. REEMPLAZA 4134 190 0601, 4134-190-0601. | VIP 21, 25, 28, 30 34, 40, 42, 45, 50, 52, 55 STAR 22, 26, 31, 36 41, 45, 55. REEMPLAZA 4611480 |

MUELLE EMBRAGUE

| | KAW | KAW | ALPN |
|------------------------|---|---|---|
| |  |  |  |
| Referencia | 921442373 | KU80010AA | SG31344 |
| Características | MUELLE EMBRAGUE TJ053E-AS50 | MUELLE EMBRAGUE TL52 PFD/TL43 PFD | MUELLE EMBRAGUE ALPN |
| Modelos | | | VIP 34, 36, 40, 41, 42, 45, 55. REEMPLAZA 3654040 |

MUELLE VÁLVULA

HND



| | |
|------------------------|------------------|
| Referencia | 140FA.1-1 |
| Características | MUELLE VALVULA |
| Modelo | GX35 COPIA |

PIPA BUJÍA

HSQ



NGK



STL



| | | | |
|------------------------|----------------|----------------|---|
| Referencia | SG31313 | SG31314 | SG31315 |
| Características | PIPA BUJÍA HSQ | PIPA BUJÍA NGK | PIPA BUJÍA STL |
| Modelos | | | CAPUCHÓN BUJÍA STL 038. REEMPLAZA 1106 405 1000 |

PISTONES

ECH



STL



STL



| | | | |
|------------------------|----------------------|------------------------------|--|
| Referencia | SG30674 | SG30686 | SG30689 |
| Características | KIT PISTON ECH | KIT PISTON STL | KIT PISTON STL |
| Modelos | REEMPLAZA P021009230 | KIT PISTON STL MS200, MS200T | KIT PISTON STL FS400, FS400-K, FS400-L, SP400. |

STL



STL



STL



| | | | |
|------------------------|----------------------|------------------------------|--|
| Referencia | SG30693 | SG30696 | SG30698 |
| Características | KIT PISTON STL | KIT PISTON STL | KIT PISTON STL |
| Modelos | KIT PISTON STL FR480 | KIT PISTON STL FR450 Y FS450 | KIT PISTON STL BR320, BR320L, BR340, BR340L, BR380, BR400, BR420, BR420C, SR320, SR340, SR400, SR420 |

PLATO MAGNÉTICO

HND



| | |
|------------------------|----------------------|
| Referencia | SGXG25-60 |
| Características | PLATO MAGNETICO GX25 |

POLEA DE ARRANQUE

KAW



STL



ALPN



| | | | |
|------------------------|---------------------------------|--|---------------------------------|
| Referencia | 591010010 | SG30620 | SG31332 |
| Características | POLEA DE ARRANQUE TJ053E/TJ045E | POLEA ARRANQUE STL | POLEA ARRANQUE ALPN Ø70MM h40,5 |
| Modelos | | POLEA ARRANQUE STL FR350, FR450. REEMPLAZA 4128-195-0400. | |

RETENES

| | HND | HND |
|------------------------|---|---|
| |  |  |
| Referencia | 140FA.3-1 | 140FA.3-2 |
| Características | RETEN ACEITE | RETEN ACEITE |
| Modelos | GX35 COPIA | GX35 COPIA |

TAPÓN COMBUSTIBLE

| | KAW | KAW | KAW |
|------------------------|--|---|--|
| |  |  |  |
| Referencia | 510482077 | 510482083 | 999966089 |
| Características | TAPON DEPOSITO TH043D/TH048D S/ VALV | TAPON DEPOSITO TJ045E/TJ053E S/VALV | TAPON DEPOSITO TJ045E/TJ053E |
| Modelos | | SUSTITUIDA POR 510482083 440 | TAMBIEN 99996-6107 |

| | HND | SPORTGARDEN | HND |
|------------------------|---|--|---|
| |  |  |  |
| Referencia | 140FA.5.1-1 | GBC4352N99 | SG30001 |
| Características | TAPON DE GASOLINA COMPLETO | TAPON DEPOSITO GBC | TAPON DE GASOLINA PLASTICO HND |
| Modelos | GX35 | | REF. ORIGINAL 17620-ZE2-013 |

| | HND | HND | STL |
|------------------------|---|---|--|
| |  |  |  |
| Referencia | SG30002 | SG30005 | SG300425 |
| Características | TAPON DE GASOLINA HND | TAPÓN DE ACEITE HND | TAPON GASOLINA |
| Modelos | REF. ORIGINAL 17620-ZH7-023 | REF. ORIGINAL HND: 15600-735-003 | Tapón de gasolina para STL FS160, FS180, FS220, FS280, FR220, FR280 (4116-350-0502, 41163500502) |

| | HND | STL | ECH |
|------------------------|---|---|---|
| |  |  |  |
| Referencia | SG30252 | SG30571 | SG31321 |
| Características | TAPÓN GASOLINA HNDGC/GCV135-160 | TAPON GASOLINA STL | TAPON DEPOSITO ECH |
| Modelos | REF. ORIGINAL 17620-ZL8-003 | TAPON GASOLINA STL REEMPLAZA 4126 350 0500, 4126 350 0502, 4126 359 0700, 4128 300 0505., 4128 350 0501, 4128 350 0502, 4128 350 0503, 4128 350 0504, 4128 350 0505, 4133 350 0501. | TAPON GASOLINA ECH BCLS-510ES, CLS-500-5010, EA-410, ES-2100-2400, ES-250ES, ES-255ES, GT-2150SI, HC-30ES, HC-30ESW, HC-40ES, HCA-265ES, MB-580 13-23, PAS-265ES, PB-2100, PB-2155, PB-235, PPT-2100. REEMPLAZA: 131004-55530 |

| | HND | KAW | KAW |
|------------------------|--|---|--|
| |  |  |  |
| Referencia | SGXG25-72-76 | 140692088 | 491162064 |
| Características | TAPON COMPLETO | VALVULA TAPON TJ045E/TJ053E | VALVULA TAPON TH043D/TH048D |
| Modelos | TAPON COMPLETO GX25 | TAMBIEN 14069-0017 400 | TAMBIEN 14069-2056 472 |

TIRADOR DE ARRANQUE

| | SPORTGARDEN | STL | STL |
|------------------------|---|--|---|
| |  |  |  |
| Referencia | SG30503 | SG31337 | SG31346 |
| Características | TIRADOR ARRANQUE UNIVERSAL | TIRADOR ARRANQUE CON CUERDA STL | POMO ARRANQUE SIN CUERDA STL |
| Modelos | | | STL ELASTOSTART 3.0MM |

TOMA DE ADMISIÓN

HND



| | |
|------------------------|----------------|
| Referencia | 140FA-6 |
| Características | TOMA ADMISION |
| Modelos | GX35 COPIA |

TUBOS DE GASOLINA

HND



| | |
|------------------------|---------------------|
| Referencia | 140FA.5.2 |
| Características | GOMA TUBOS DEPOSITO |
| Modelos | GX35 COPIA |

HND



| | |
|------------------------|-----------------------|
| Referencia | 140FA-1 |
| Características | TUBO IGUALADO PRESION |
| Modelos | GX35 COPIA |

HND



| | |
|------------------------|-----------------|
| Referencia | 140FA-21 |
| Características | TUBO CARBURADOR |
| Modelos | GX35 COPIA |

SPORTGARDEN



| | |
|------------------------|---|
| Referencia | SG300437 |
| Características | TUBO CARBURADOR MANGUERA 3mmx6.2mm (L:15m) |

SPORTGARDEN



| | |
|------------------------|---------------------------------|
| Referencia | SG300438 |
| Características | MANGUERA GASOLINA 2.5X5mm (15m) |

SPORTGARDEN



| | |
|------------------------|---------------------------------|
| Referencia | SG300439 |
| Características | MANGUERA GASOLINA 3.5X5mm (15m) |

SPORTGARDEN



| | |
|------------------------|---|
| Referencia | SG30486 |
| Características | MANGUERA GASOLINA EXT6.5 INT3.5 L15m |

SPORTGARDEN



| | |
|------------------------|---|
| Referencia | SG30487 |
| Características | MANGUERA GASOLINA EXT7.6 INT4.5 L15m |

STL



| | |
|------------------------|--|
| Referencia | SG30559 |
| Características | TUBO GASOLINA STL FS120, FS200, FS250, FS350, FS450. REEMPLAZA: 4128- 358-0800 |

| | HND | SPORTGARDEN | KAW |
|------------------------|---|--|---|
| |  |  |  |
| Referencia | SG30919 | SG31323 | SG31324 |
| Características | GRIFO HND | TUBO GASOLINA CON PASAMURO | TUBOS GASOLINA CON PASAMURO KW |

| | SPORTGARDEN | HND |
|------------------------|---|---|
| |  |  |
| Referencia | SG31354 | SGXG25-78-81 |
| Características | GRIFO GASOLINA | JUEGO TUBOS Y FILTRO |

VÁLVULAS

| | HND | HND | HND |
|------------------------|---|---|---|
| |  |  |  |
| Referencia | 140FA.1-3 | 140FA.1-4 | 140FA-20 |
| Características | VALVULA ESCAPE | VALVULA ADMISION | TAPA BALANCINES |
| Modelos | GX35 COPIA | GX35 COPIA | GX35 COPIA |

MOTORES ELÉCTRICOS

MOTORES ELÉCTRICOS

MOTORES ELÉCTRICOS

| | SPORTGARDEN | SPORTGARDEN | |
|------------------------|---|--|---|
| |  |  |  |
| Referencia | MM1.5 | MM2.5MC90 | MM3 |
| Características | MOTOR MOLINO MONOFASICO 1.5HP | MOTOR MOLINO MONOFASICO HP 2.5 2P | MOTOR MOLINO MONOF. HP3 2P C/TER. |

| | SPORTGARDEN | SPORTGARDEN | SPORTGARDEN |
|------------------------|---|---|---|
| |  |  |  |
| Referencia | SL90L4E | MY802-4 | 9042430 |
| Características | MOTOR MOLINO 2HP 1500RPM B3/B5 MONOFASICO. | MOTOR 1HP 220V 50 HZ | MOTOR MOLINO BIDON 4T 1200W + PROTECCIÓN FASTON |

MOTOSIERRAS

AMORTIGUADORES
BOMBA DE ENGRASE
CABLES ACELERADOR
DESCOMPRESORES
ESPADAS
PIÑONES
PUNTERAS ESPADA
REMACHES CADENA
RODAMIENTOS PIÑÓN
TAPA CADENA
TAPON ACEITE

AMORTIGUADORES

| | HSQ | HSQ | HSQ |
|------------------------|---|---|---|
| |  |  |  |
| Referencia | SG30106 | SG30107 | SG30108 |
| Características | AMORTIGUADOR | AMORTIGUADOR | AMORTIGUADOR |
| Máquina | AMORTIGUADORES | AMORTIGUADORES | AMORTIGUADORES |
| Modelo | AMORTIGUADORES Amortiguador Husq 501 62 87-01 61, 268 - Agujero Ø (mm): 5 | HUSQ (501 76 39-02) 51, 55 Agujero Ø8.2mm | HUSQ 501 86 70-01 254 |
| | HSQ | HSQ | HSQ |
| |  |  |  |
| Referencia | SG30109 | SG30110 | SG30111 |
| Características | AMORTIGUADOR | AMORTIGUADOR | AMORTIGUADOR |
| Máquina | AMORTIGUADORES | AMORTIGUADORES | AMORTIGUADORES |
| Modelo | HUSQ 503 16 16-02 40,45,50 - Agujero Ø (mm): 12,3 | Amortiguador Husq 501 27 63-01 44, 61, 66, 266, 444, 480 Agujero Ø (mm): 5 | Amortiguador Husq 501 77 35-01 61, 66, 238, 242, 266, 268 Agujero Ø (mm): 5 |
| | HSQ | HSQ | HSQ |
| |  |  |  |
| Referencia | SG30112 | SG30113 | SG30114 |
| Características | AMORTIGUADOR | AMORTIGUADOR | AMORTIGUADOR |
| Máquina | AMORTIGUADORES | AMORTIGUADORES | AMORTIGUADORES |
| Modelo | Amortiguador Husq 501 69 94-01 238,242,266 | Amortiguador Husq 501 23 05-01 44, 61, 266, 444, 480 Agujero Ø (mm): 5 | Amortiguador Husq 501 81 47-01 281, 288 |

| | HSQ | HSQ | HSQ |
|------------------------|---|---|---|
| |  |  |  |
| Referencia | SG30115 | SG30116 | SG30117 |
| Características | AMORTIGUADOR | AMORTIGUADOR | AMORTIGUADOR |
| Máquina | AMORTIGUADORES | AMORTIGUADORES | AMORTIGUADORES |
| Modelo | Amortiguador Husq 501 77 34-01 | Amortiguador Husq 503 84 61-01 365, 372, 385 | Amortiguador Husq 503 86 92-01 340, 350, 359 |

| | HSQ | HSQ | HSQ |
|------------------------|--|--|--|
| |  |  |  |
| Referencia | SG30118 | SG30119 | SG30120 |
| Características | AMORTIGUADOR | AMORTIGUADOR | AMORTIGUADOR |
| Máquina | AMORTIGUADORES | AMORTIGUADORES | AMORTIGUADORES |
| Modelo | Amortiguador Husq 501 77 34-01 | Amortiguador Husq 503 86 93-01 340, 345, 350 | Amortiguador Husq 503 85 41-01 340, 345, 346, 350, 353 |

| | HSQ | HSQ | HSQ |
|------------------------|---|---|---|
| |  |  |  |
| Referencia | SG30121 | SG30122 | SG30123 |
| Características | AMORTIGUADOR | AMORTIGUADOR | AMORTIGUADOR |
| Máquina | AMORTIGUADORES | AMORTIGUADORES | AMORTIGUADORES |
| Modelo | Amortiguador Husq 503 89 83-01 340, 345, 346, 350, 353 | Amortiguador Husq 503 63 76-013 62, 365, 371, 372 | Amortiguador Husq 503 89 56-01 3 62, 365, 371, 372 |

| | HSQ | HSQ | HSQ |
|------------------------|---|--|---|
| |  |  |  |
| Referencia | SG30124 | SG30125 | SG30126 |
| Características | AMORTIGUADOR | AMORTIGUADOR | AMORTIGUADOR |
| Máquina | AMORTIGUADORES | AMORTIGUADORES | AMORTIGUADORES |
| Modelo | Amortiguador Husq 503 63 75-02 3 62, 365, 371, 373, 374, 375 | Amortiguador Husq 506 01 47-01 33, 36, 40, 45 | Amortiguador Husq 530 04 79-34 33, 36, 40, 45 |

| | HSQ | HSQ | HSQ |
|------------------------|---|--|---|
| |  |  |  |
| Referencia | SG30127 | SG30128 | SG30129 |
| Características | AMORTIGUADOR | AMORTIGUADOR | AMORTIGUADOR |
| Máquina | AMORTIGUADORES | AMORTIGUADORES | AMORTIGUADORES |
| Modelo | Amortiguador Husq 503 63 76-02 3 65, 371, 372 | Amortiguador Husq 536 01 46-01 40 | Amortiguador Husq 545 06 31-01 235, 235E, 240, 240E |

| | HSQ | HSQ | HSQ |
|------------------------|---|--|---|
| |  |  |  |
| Referencia | SG30130 | SG30131 | SG30132 |
| Características | AMORTIGUADOR | AMORTIGUADOR | AMORTIGUADOR |
| Máquina | AMORTIGUADORES | AMORTIGUADORES | AMORTIGUADORES |
| Modelo | Amortiguador Husq 545 03 38-01 235, 235E, 240, 240E | Amortiguador Husq 545 03 39-01 235, 235E, 240, 240E | Amortiguador Husq 504 79 56-01 435, 440 |



| | HSQ | HSQ | STL |
|------------------------|---|---|--|
| Referencia | SG30133 | SG30134 | SG30136 |
| Características | AMORTIGUADOR | AMORTIGUADOR | AMORTIGUADOR |
| Máquina | AMORTIGUADORES | AMORTIGUADORES | AMORTIGUADORES |
| Modelo | Amortiguador Husq 544 10 12-01 445, 450 | Amortiguador Husq 537 30 46-01 445, 445E, 450, 450E | Amortiguador Stl 1116-790-9600 0 10, 011, 012, 015 Agujero Ø (mm): 5 |



| | STL | STL | STL |
|------------------------|--|---|--|
| Referencia | SG30137 | SG30138 | SG30139 |
| Características | AMORTIGUADOR | AMORTIGUADOR | AMORTIGUADOR |
| Máquina | AMORTIGUADORES | AMORTIGUADORES | AMORTIGUADORES |
| Modelo | Amortiguador Stl 1120-790-9600 010, 011, 012, 019T Agujero Ø (mm): 4 | Amortiguador Stl 1123-791-2805 021,023, 025, 029, 039 | Amortiguador Stl 1123-790-9900 021, 023, 025 |





| | STL | STL | STL |
|------------------------|---|---|--|
| Referencia | SG30140 | SG30141 | SG30142 |
| Características | AMORTIGUADOR | AMORTIGUADOR | AMORTIGUADOR |
| Máquina | AMORTIGUADORES | AMORTIGUADORES | AMORTIGUADORES |
| Modelo | Amortiguador Stl 1127-790-9900 029, 039 | Amortiguador Stl 1132-791-2800 MS270, MS280 | Amortiguador Stl 1123-791-2800 MS170, MS180, MS270 Øext. (mm): 20,9/24,1 Agujero Ø (mm): 6,2 |









| | STL | STL | STL |
|------------------------|--|--|---|
| |  |  |  |
| Referencia | SG30143 | SG30144 | SG30145 |
| Características | AMORTIGUADOR | AMORTIGUADOR | AMORTIGUADOR |
| Máquina | AMORTIGUADORES | AMORTIGUADORES | AMORTIGUADORES |
| Modelo | Amortiguador Stl 1125-791-7306, 1125-791-7307, 1125-791-7308 024, 026, 028, 034, 036, 038, 044, 046, 064, 066 MS240, MS360, MS380, MS440, MS460, MS660 | Amortiguador Stl 1121-790-9909 024, 026, 028, 038, MS380, MS390 Agujero Ø (mm): 6,2 | Amortiguador Stl 1118-790-9930 028, 038 Dos agujeros de fijación Ø (mm): 6,4 |
| | STL | STL | STL |
| |  |  |  |
| Referencia | SG30146 | SG30148 | SG30149 |
| Características | AMORTIGUADOR | AMORTIGUADOR | AMORTIGUADOR |
| Máquina | AMORTIGUADORES | AMORTIGUADORES | AMORTIGUADORES |
| Modelo | Amortiguador Stl 1125-790-9906 034, 036, 046, 064, 066 Agujero Ø (mm): 6,2 | Amortiguador Stl 1128-790-9900 044 Agujero Ø (mm): 4,6 Dos agujeros fijación (mm): 6,2 | Amortiguador Stl 1122-790-9920 064, 066 Agujero Ø (mm): 6,1 Rosca M5 |
| | STL | STL | STL |
| |  |  |  |
| Referencia | SG30150 | SG30151 | SG30152 |
| Características | AMORTIGUADOR | AMORTIGUADOR | AMORTIGUADOR |
| Máquina | AMORTIGUADORES | AMORTIGUADORES | AMORTIGUADORES |
| Modelo | Amortiguador Stl 1122-790-9901 064, 066 Agujero Ø (mm): 6,2 | Amortiguador Stl 1135-791-3100 MS341, MS361 | Amortiguador Stl 1133-791-3100 MS270, MS280 |

| | STL | STL | STL |
|------------------------|---|--|---|
| |  |  |  |
| Referencia | SG30153 | SG30154 | SG30155 |
| Características | AMORTIGUADOR | AMORTIGUADOR | AMORTIGUADOR |
| Máquina | AMORTIGUADORES | AMORTIGUADORES | AMORTIGUADORES |
| Modelo | Amortiguador Stl 0000-791-3104 MS181, MS211 | Amortiguador Stl 0000-791-3103 MS181, MS211 | Amortiguador Stl 1138-790-8302 441 |

| | STL | STL |
|------------------------|---|---|
| |  |  |
| Referencia | SG30156 | SG30157 |
| Características | AMORTIGUADOR | AMORTIGUADOR |
| Máquina | AMORTIGUADORES | AMORTIGUADORES |
| Modelo | Amortiguador Stl 1138-790-8311 411, 441C | Amortiguador Stl 1135-790-8300 341, 361, 361C |

BOMBA DE ENGRASE

| | ECH | ECH | ECH |
|------------------------|---|--|---|
| |  |  |  |
| Referencia | SG30089 | SG30090 | SG30091 |
| Características | BOMBA ENGRASE ECH, CMPTBLE. SG260AE | BOMBA ENGRASE ECH | BOMBA ENGRASE ECH |
| Máquina | BOMBA ENGRASE | BOMBA ENGRASE | BOMBA ENGRASE |
| Modelo | CS-340 437002-39130 | CS-280TES, CS-360TES 52142-00980; C022-000020 | CS-2600, CS-2700ES, CS-320T, CS-320TES, CS-350WES 52130-00620; P021-001980 |

| | ECH | ECH | HSQ |
|------------------------|--|--|---|
| |  |  |  |
| Referencia | SG30092 | SG30093 | SG30094 |
| Características | BOMBA DE ENGRASE ECH | BOMBA ENGRASE ECH | BOMBA ENGRASE HUSQ |
| Máquina | BOMBA ENGRASE | BOMBA ENGRASE | BOMBA ENGRASE |
| Modelo | CES-260TES, CS-260T, CS-260TES, CS-270WES, CS-280WES, CS320TES, CS350TES, CS350WES, CS420ES 52142-01000; P021-010890 | CS370ES, CS420ES P021-012150 | 340, 345, 350 503 93 21-01 |
| | HSQ | HSQ | HSQ |
| |  |  |  |
| Referencia | SG30095 | SG30096 | SG30097 |
| Características | BOMBA ENGRASE HUSQ | BOMBA ENGRASE HUSQ | BOMBA ENGRASE HUSQ |
| Máquina | BOMBA ENGRASE | BOMBA ENGRASE | BOMBA ENGRASE |
| Modelo | 345, 346, 353, 360 544 18 01-03; 544 18 01-01 | 365, 372 503 52 13-01; 503 52 13-01 | 51, 55 5017776-01; 5036601-02; 501 77 76-01; 503 66 01-02 |
| | HSQ | STL | STL |
| |  |  |  |
| Referencia | SG30098 | SG30099 | SG30100 |
| Características | BOMBA ENGRASE HUSQ | BOMBA ENGRASE STL | BOMBA ENGRASE STL |
| Máquina | BOMBA ENGRASE | BOMBA ENGRASE | BOMBA ENGRASE |
| Modelo | 61, 268, 272 501 51 25-01 | 038, MS380, MS381 11196403200; 1119-640-3200 | 066, MS660 11226403205; 1122-640-3205 |

| | STL | STL | STL |
|------------------------|---|---|---|
| |  |  |  |
| Referencia | SG30101 | SG30102 | SG30103 |
| Características | BOMBA ENGRASE STL | BOMBA DE ENGRASE STL | BOMBA ENGRASE STL |
| Máquina | BOMBA ENGRASE | BOMBA ENGRASE | BOMBA ENGRASE |
| Modelo | 023, 025, MS230, MS250 11236403201; 1123-640-3201 | 024, 026, MS240, MS260 1121643203; 1121-640-3203 | 029, 039, MS290, MS310, MS311, MS390, MS391 11276403204; 1127-640-3204 |

| | STL | STL | STL |
|------------------------|---|---|---|
| |  |  |  |
| Referencia | SG30104 | SG30105 | SG30103 |
| Características | BOMBA ENGRASE STL | BOMBA DE ENGRASE STL | BOMBA ENGRASE STL |
| Máquina | BOMBA ENGRASE | BOMBA ENGRASE | BOMBA ENGRASE |
| Modelo | 034, 036, MS340, MS360 11256403201; 1125-640-3201 | MS341, MS361 11356403200; 1135-640-3200 | 029, 039, MS290, MS310, MS311, MS390, MS391 11276403204; 1127-640-3204 |

CABLES ACELERADOR

SPORTGARDEN



| | |
|------------------------|------------------------|
| Referencia | SG30512 |
| Características | CABLE ACELERADOR CS65T |
| Máquina | CABLE ACELERADOR |

DESCOMPRESORES

HSQ



| | |
|------------------------|-----------------------------|
| Referencia | SG30502 |
| Características | DESCOMPRESOR MOTOSIERRA HSQ |
| Máquina | DESCOMPRESOR |
| Modelo | COMPATIBLE CON HSQ |

ESPADAS

SPORT GARDEN



| Referencia | Paso | Galga | Longitud | Estrellas de inversión | Enganche | Eslabones |
|------------|---------|-------|----------|------------------------|----------|-----------|
| SG31001 | 3/8" BP | 0,50" | 14" | | 0,1 | 52 |

SPORT GARDEN



| Referencia | Paso | Galga | Longitud | Estrellas de inversión | Enganche | Eslabones |
|------------|---------|-------|----------|------------------------|----------|-----------|
| SG31002 | 3/8" BP | 0,50" | 16" | | 0,1 | 56 |

SPORT GARDEN



| Referencia | Paso | Galga | Longitud | Estrellas de inversión | Enganche | Eslabones |
|------------|---------|-------|----------|------------------------|----------|-----------|
| SG31003 | 3/8" BP | 0,50" | 12" | | 10 | 45 |

SPORT GARDEN

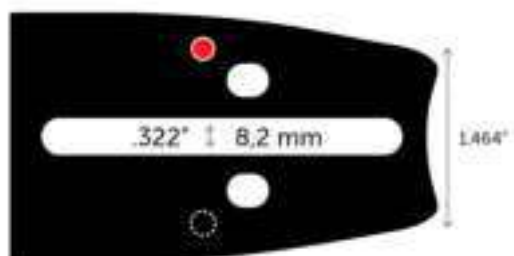

| Referencia | Paso | Galga | Longitud | Estrellas de inversión | Enganche | Eslabones |
|------------|-------|-------|----------|------------------------|----------|-----------|
| SG31004 | .325" | 0,58" | 15" | | 10 | 64 |

SPORT GARDEN

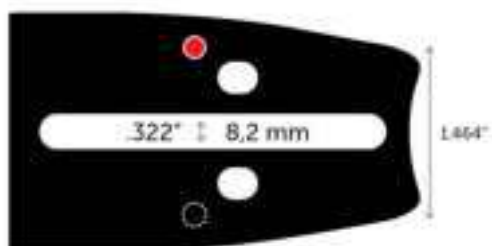

| Referencia | Paso | Galga | Longitud | Estrellas de inversión | Enganche | Eslabones |
|------------|-------|-------|----------|------------------------|----------|-----------|
| SG31005 | .325" | 0,50" | 18" | | 10 | 72 |

SPORT GARDEN

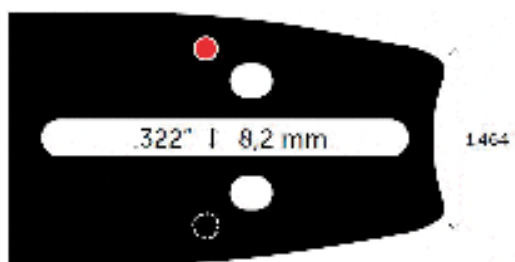

| Referencia | Paso | Galga | Longitud | Estrellas de inversión | Enganche | Eslabones |
|------------|-------|-------|----------|------------------------|----------|-----------|
| SG31006 | .325" | 0,58" | 18" | | 10 | 72 |

SPORT GARDEN



| Referencia | Paso | Galga | Longitud | Estrellas de inversión | Enganche | Eslabones |
|------------|-------|-------|----------|------------------------|----------|-----------|
| SG31007 | .325" | 0,58" | 18" | | 10 | 68 |

SPORT GARDEN

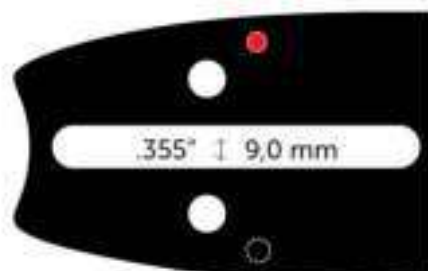

| Referencia | Paso | Galga | Longitud | Estrellas de inversión | Enganche | Eslabones |
|------------|------|-------|----------|------------------------|----------|-----------|
| SG31008 | 3/8" | 0,58" | 18" | | | 68 |

SPORT GARDEN

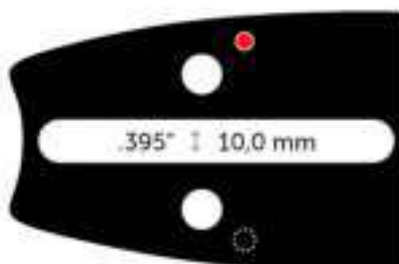

| Referencia | Paso | Galga | Longitud | Estrellas de inversión | Enganche | Eslabones |
|------------|------|-------|----------|------------------------|----------|-----------|
| SG31009 | 3/8" | 0,58" | 18" | | | 68 |

SPORT GARDEN



| Referencia | Paso | Galga | Longitud | Estrellas de inversión | Enganche | Eslabones |
|------------|------|-------|----------|------------------------|----------|-----------|
| SG31010 | 3/8" | 0,58" | 16" | | | 60 |

SPORT GARDEN



| Referencia | Paso | Galga | Longitud | Estrellas de inversión | Enganche | Eslabones |
|------------|------|-------|----------|------------------------|----------|-----------|
| SG31011 | 3/8" | 0,63" | 18" | | | 66 |

SPORT GARDEN



| Referencia | Paso | Galga | Longitud | Estrellas de inversión | Enganche | Eslabones |
|------------|------|-------|----------|------------------------|----------|-----------|
| SG31012 | 3/8" | 0,63" | 20" | | | 72 |

SPORT GARDEN



| Referencia | Paso | Galga | Longitud | Estrellas de inversión | Enganche | Eslabones |
|------------|------|-------|----------|------------------------|----------|-----------|
| SG31015 | | 0,63" | 10" | 25 cm | | 72 |

SPORT GARDEN



| Referencia | Paso | Galga | Longitud | Estrellas de inversión | Enganche | Eslabones |
|------------|------|-------|----------|------------------------|----------|-----------|
| SG31016 | | 0,63" | 12" | 25 cm | | |

SPORT GARDEN



| Referencia | Paso | Galga | Longitud | Estrellas de inversión | Enganche | Eslabones |
|------------|------|-------|----------|------------------------|----------|-----------|
| SG31017 | | 0,63" | 14" | 35 cm | | 72 |

PIÑONES



| Referencia | SG31021 | SG31022 | SG31023 |
|-----------------|--|---------------------------------------|---|
| Características | PIÑÓN CADENA 325X7 | PIÑÓN CADENA 325X7 | PIÑÓN CADENA 325X7 |
| Máquina | PIÑÓN CADENA | PIÑÓN CADENA | PIÑÓN CADENA |
| Modelo | HUSQ.36/41/136/141/137/142/235/236/240 JONSRD 2035-2036-2040 PRTNR 365-405 | HUSQ.40/45 JONSRD 2041-2045-2050-2063 | HUSQ. 346/351/353/345 JONSRD 2145-2149-2159-2141-2159-2141-2150 |



| Referencia | SG31024 | SG31025 | SG31026 |
|-----------------|--|--|--|
| Características | PIÑÓN CADENA 325X7 | PIÑÓN CADENA 325X7 | PIÑÓN CADENA 3/8X7 |
| Máquina | PIÑÓN CADENA | PIÑÓN CADENA | PIÑÓN CADENA |
| Modelo | HUSQ. 50/51/55/154/254/262 JONSRD 490-590 PARTNR 500-545 | HUSQ. 350/345/445/450 JONSRD CS2245-CS2250 | HUSQ. 61/66/162/266/268/272/372 JONSRD 625/630/670 |

| | HSQ | HSQ | HSQ |
|------------------------|---|--|---|
| |  |  |  |
| Referencia | SG31027 | SG31028 | SG31029 |
| Características | PIÑÓN CADENA 3/8X7 | PIÑÓN CADENA 3/8X7 | PIÑÓN CADENA 3/8X7 |
| Máquina | PIÑÓN CADENA | PIÑÓN CADENA | PIÑÓN CADENA |
| Modelo | HUSQ. 61/66/162/266/268/272/372 JONS-RD 625/630/670 | HUSQ. 365/371/372/570/575/576 JONSRD 2165 | HUSQ. 281/285/288/394/395 JONSRD 2100 |

| | STL | STL | STL |
|------------------------|---|---|---|
| |  |  |  |
| Referencia | SG31030 | SG31031 | SG31032 |
| Características | PIÑÓN CADENA 325X7 | PIÑÓN CADENA 3/8X6 | PIÑÓN CADENA 325X7 |
| Máquina | PIÑÓN CADENA | PIÑÓN CADENA | PIÑÓN CADENA |
| Modelo | STL 017/018/019/021/023/MS1700/180/210/230/190/210/250 | STL 017/018/019/021/023/MS1700/180/210/230/190/210/250 | STL 024/026/MS240/260/260PRO/MS270 |

| | STL | HSQ | HSQ |
|------------------------|---|--|---|
| |  |  |  |
| Referencia | SG31033 | SG30472 | SG30473 |
| Características | PIÑÓN CADENA 3/8X7 | PIÑÓN ENGRASE HSQ | PIÑÓN ENGRASE HSQ |
| Máquina | PIÑÓN CADENA | PIÑÓN ENGRASE | PIÑÓN ENGRASE |
| Modelo | STL 029/034/036/039/MS290/310/360/390 | 365, 372 503 75 61-02 | 61, 266, 268, 272 501 51 38-01 |

| | HSQ | HSQ | HSQ |
|------------------------|---|---|---|
| |  |  |  |
| Referencia | SG30474 | SG30475 | SG30476 |
| Características | PIÑÓN ENGRASE HSQ | PIÑÓN ENGRASE HSQ | PIÑÓN ENGRASE HSQ |
| Máquina | PIÑÓN ENGRASE | PIÑÓN ENGRASE | PIÑÓN ENGRASE |
| Modelo | 281, 288, 395 503 55 75-01 | 346, 351, 353 503 89 21-02 | 340, 345, 350 503 93 18-01 |

| | HSQ | STL | STL |
|------------------------|---|---|---|
| |  |  |  |
| Referencia | SG30477 | SG30478 | SG30479 |
| Características | PIÑÓN ENGRASE HSQ | PIÑÓN ENGRASE STL | PIÑÓN ENGRASE STL |
| Máquina | PIÑÓN ENGRASE | PIÑÓN ENGRASE | PIÑÓN ENGRASE |
| Modelo | 355, 357, 359 503 91 29-02 | 017, 018, 019, 021, 023, 025 1123-640-7102 | 044, 046, 341, MS440, MS460 1128-640-7110 |

| | STL | STL |
|------------------------|---|---|
| |  |  |
| Referencia | SG30480 | SG30481 |
| Características | PIÑÓN ENGRASE STL | PIÑÓN ENGRASE STL |
| Máquina | PIÑÓN ENGRASE | PIÑÓN ENGRASE |
| Modelo | 029, 039, 034, 036 1125-640-7110 | 024, 026, MS240, MS260 1128-640-7112; 1121-647-3100 |

PUNTERAS ESPADA

| | SPORTGARDEN | SPORTGARDEN | SPORTGARDEN |
|------------------------|---|--|---|
| |  |  |  |
| Referencia | SG31013 | SG31014 | SG31018 |
| Características | PUNTERA ESPADA WINDSOR 325 | PUNTERA ESPADA WINDSOR 3/8 | PUNTERA ESPADA TIPO OREGON 325 |
| Máquina | PUNTERAS Y SABLES | PUNTERAS Y SABLES | PUNTERAS Y SABLES |
| Modelo | | | |

| | SPORTGARDEN | SPORTGARDEN |
|------------------------|--|---|
| |  |  |
| Referencia | SG31019 | SG31020 |
| Características | PUNTERA ESPADA MOTOSIERRA TIPO OREGON 3/8 | PUNTERA ESPADA MOTOSIERRA TIPO OREGON 404 |
| Máquina | PUNTERAS Y SABLES | PUNTERAS Y SABLES |
| Modelo | | |

REMACHES CADENA

| | SPORTGARDEN | SPORTGARDEN |
|------------------------|---|--|
| |  |  |
| Referencia | SG31044 | SG31045 |
| Características | REMACHE CADENA 3/8LP 050 (BOLSA 25 UDS) | REMACHE CADENA 3/8LP 058 (BOLSA 25 UDS) |
| Máquina | REMACHES CADENA | REMACHES CADENA |
| Modelo | | |

| | SPORTGARDEN | SPORTGARDEN |
|------------------------|---|---|
| |  |  |
| Referencia | SG31046 | SG31047 |
| Características | REMACHE CADENA 3/8LP 050 (BOLSA 25 UDS) | REMACHE CADENA 3/8LP 058 (BOLSA 25 UDS) |
| Máquina | REMACHES CADENA | REMACHES CADENA |
| Modelo | | |

RODAMIENTOS PIÑÓN

| | HSQ | HSQ | HSQ |
|------------------------|--|--|--|
| |  |  |  |
| Referencia | SG31034 | SG31035 | SG31036 |
| Características | RODAMIENTO PIÑON CADENA 14.5X17.5X16 mm | RODAMIENTO PIÑON CADENA 11X13X10 mm | RODAMIENTO PIÑON CADENA 13X16X12,5 mm |
| Máquina | ROADMIENTOS PIÑÓN | ROADMIENTOS PIÑÓN | ROADMIENTOS PIÑÓN |
| Modelo | Husq. 281/285/288/394/395 Jonsrd 2100 14,5X17,5X16 mm | HUSQ. 36/41/136/141/137/142/235 /236/240 JONSRD 2035-2036-2040 11X13X10mm | HUSQ.50/51/55/154/254/262 JONSRD 490-590 13X16X12,5mm |

| | HSQ | HSQ | HSQ |
|------------------------|---|---|---|
| |  |  |  |
| Referencia | SG31037 | SG31038 | SG31036 |
| Características | RODAMIENTO PIÑON CADENA 13X17.5X12,5 mm | RODAMIENTO PIÑON CADENA 13X16X17 mm | RODAMIENTO PIÑON CADENA 13X16X12,5 mm |
| Máquina | ROADMIENTOS PIÑÓN | ROADMIENTOS PIÑÓN | ROADMIENTOS PIÑÓN |
| Modelo | HUSQ,61/66/162/266/268/272/372 JONS-RD 625/630/670 13X17,5X12,5mm | HUSQ. 365/371/372/570/575/576 13X16X17mm | HUSQ.50/51/55/154/254/262 JONSRD 490-590 13X16X12,5mm |

TAPA CADENA

| | SPORTGARDEN | SPORTGARDEN |
|------------------------|---|---|
| |  |  |
| Referencia | SG30483 | SG30484 |
| Características | TUERCAS TAPA CADENA 10X1.5 | TUERCAS TAPA CADENA M8X1.25 |
| Máquina | TAPA CADENA | TAPA CADENA |
| Modelo | | |

TAPON ACEITE

| | HSQ | STL | HSQ |
|------------------------|--|---|---|
| |  |  |  |
| Referencia | SG300400 | SG300401 | SG300402 |
| Características | TAPON ACEITE | TAPON ACEITE | TAPON ACEITE |
| Máquina | TAPON ACEITE | TAPON ACEITE | TAPON ACEITE |
| Modelo | Tapón aceite para HUSQ 136, 137, 141, 142 (5017656-02) | Tapón aceite para STL: 0000-350-0526, 0000-350-0537 | Tapón de aceite para HUQ 36, 41, 42, 50, 55, 154, 254XP, 262, 281, 288, 394 & 3120 (501 76 56 01) |

| | STL |
|------------------------|---|
| |  |
| Referencia | SG30570 |
| Características | TAPON ACEITE STL |
| Máquina | TAPON ACEITE |
| Modelo | TAPON GASOLINA STL 020, 020T (Type 1129), 021, 023, 024, 025, 026, 028, 034, 036, 036QS, 038, 042AV, 044, 046, 048 and oil tank cap for models 020, 020T (Type 1129), 021, 023, 025, 026, 028, 029, 034, 036, 036QS, 038, 039, 044, 046, 048, 050, 051, 064, 066, 075, 076, 084, 088, MS290, MS310, MS390, MS640, MS650, MS660, P835, P840, TS50. REEMPLAZA: 0000-350-0508, 0000-350-0520, 0000-350-0521, 0000-350-0522, 0000-350-0523, 0000-350-0530, 1117-350-0500, 1117-350-0520, 1124-350-0500. |

| | SPORTGARDEN | SPORTGARDEN | SPORTGARDEN |
|------------------------|--|---|---|
| |  |  |  |
| Referencia | SG30229 | SG30230 | SG30231 |
| Características | TENSOR CADENA HSQ | TENSOR CADENA HSQ | TENSOR CADENA HSQ |
| Máquina | TENSOR CADENA | TENSOR CADENA | TENSOR CADENA |
| Modelo | 501537101 51, 61, 66, 162, 181, 266, 268, 272, 281, 288 | 5011546301, 501452701 42, 44, 50 Rancher, 51, 55, 238, 242, 444 | 537-04-04-21, 537-04-41-02 362XP, 385, 385XP, 390, 570, 575XP, 576XP |
| | HSQ | STL | STL |
| |  |  |  |
| Referencia | SG30232 | SG30233 | SG30234 |
| Características | TENSOR CADENA HSQ | TENSOR CADENA STL | TENSOR CADENA STL |
| Máquina | TENSOR CADENA | TENSOR CADENA | TENSOR CADENA |
| Modelo | 537 07 12-01 340, 345, 346, 350, 353, 357, 359 | 1110-664-1600, 1110-664-1500 0 15, 020 (Tipo1114), 030, 031, 031AV, 032, 041AV, 041FB, 041G, 042AV, 045, 048, 056, E10, E15 | 1120-664-1500, 1118-664-1600 009, 010, 011, 012, 017, 018, 019T, 021, 023, 024, 025, 028, 032, 034, 038, 041AV, 042AV, 048, 056, MS170, MS180, MS190T, MS191T, MS240, MS340, E14, E140, E160, MSE200C |
| | STL | STL | STL |
| |  |  |  |
| Referencia | SG30235 | SG30236 | SG30237 |
| Características | TENSOR CADENA STL | TENSOR CADENA STL | TENSOR CADENA STL |
| Máquina | TENSOR CADENA | TENSOR CADENA | TENSOR CADENA |
| Modelo | 1125-007-1021 024, 026, 028, 034, 036, 044, 046, 064, MS260, MS261, MS270, MS280, MS340, MS341, MS360, MS361, MS380, MS381, MS440, MS441, MS460, MS640, MS650, MS660 | 1123-640-1900, 1123-664-1400 MS230, MS250 | 1123-007-1000 021, 023, 025, 025C, MS160, MS180C |



PULVERIZACIÓN

BOMBAS
BOQUILLAS
LANZAS
MANGUERA

BOMBAS



| | SPORTGARDEN | SPORTGARDEN | SPORTGARDEN |
|------------------------|---|--|---|
| |  |  |  |
| Referencia | GMBF 20 | SG210011 | A001013001 |
| Características | BOMBA DE DIAFRAGMA GMBF20 CON REDUC | BOMBA COMPLETA SG-P768K/G | BOMBA SULF ELECTRICA |
| Modelos | | OS-P768K - OS-P980 - SG P60T | |

BOQUILLAS

| | SPORTGARDEN | SPORTGARDEN | SPORTGARDEN |
|------------------------|--|--|--|
| |  |  |  |
| Referencia | A001027 | A001032 | A001026 |
| Características | BOQUILLA DOBLE SULF ELECTRICA | BOQUILLA FLOR 8 ORIFICIOS SULF ELECTRICA | BOQUILLA SULF ELECTRICA |
| Modelos | | | |

| | SPORTGARDEN | SPORTGARDEN |
|------------------------|---|--|
| |  |  |
| Referencia | A001028 | A005012 |
| Características | BOQUILLA SULF ELECTRICA | BOQUILLA SULF ELECTRICA |
| Modelos | | |

LANZAS

| | SPORTGARDEN | SPORTGARDEN | |
|------------------------|---|--|---|
| |  |  |  |
| Referencia | SG D-B5 | SG D-L4 | 250 |
| Características | LANZA PARA SULFATADORA | LANZA PARA SULFATADORA | PISTOLA M.94 |
| Modelos | | | |

| | SPORTGARDEN |
|------------------------|---|
| |  |
| Referencia | 300 |
| Características | PISTOLETE SIN FIN 30cms |
| Modelos | |

MANGUERA

| | SPORTGARDEN |
|------------------------|---|
| |  |
| Referencia | 9150480840000 |
| Características | METRO MANGUERA RAGNO N 40 BAR D.8 X 14 |
| Modelos | |

VAREADORES

CABEZALES
VARETAS

CABEZALES

| | SPORTGARDEN | SPORTGARDEN |
|------------------------|---|---|
| |  |  |
| Referencia | SGVAREADORCABVAR | SGVKDB |
| Características | CABEZAL VAREADOR COMPLETO SG VAREADOR 1 BIELA | KIT DOBLE BIELA SG VAREADOR |

VARETAS

SPORTGARDEN



| | |
|------------------------|-------------------------------|
| Referencia | 2320061522 |
| Características | PLATAFORMA PORTA PUNTERAS "Z" |

SPORTGARDEN



| | |
|------------------------|---------------------|
| Referencia | 4GS-50.1.3 |
| Características | VARETAS SG VAREADOR |



1

PEDIDOS

Realice pedidos de la forma más cómoda durante los 365 días del año, y **además con un 3% de descuento.**

DOCUMENTACIÓN PRODUCTOS

Acceso y descarga de manuales, despieces y fichas técnicas de todos nuestros productos.

2



3

STOCK

Podrá consultar el stock de un producto y ver si lo tenemos disponible en nuestro almacén para el envío inmediato.

PERFIL COMPLETO 360°

En su perfil podrá consultar el estado de su pedido, descargar facturas en PDF, albaranes, y realizar gestiones documentales de datos.

4



5

OFERTAS

Podrá visualizar las novedades, productos en oferta, así como sus precios netos.

Disfrute de las ventajas que le ofrecemos. Realice su pedido en cuestión de minutos

Solicite sus claves en ausavil o en nuestro mail mkt-tools@ausavil.com

ENOIL



FABRICANTES DE DEPÓSITOS



APLICACIONES:

Soluciona perfectamente el pelado de la piel marrón fina en la que viene envuelta la almendra. Recomendada para uso en grandes cantidades de producción. Uso profesional y particular.

PELADORA E



Peladora de almendra

| | |
|-----------------|-------------------------------|
| Motor eléctrico | 220V-50Hz |
| Potencia | 2,5 hp |
| Producción | 750 kg/h * |
| Embalaje | 1.050 x 590 x 1.090 mm |
| Peso | 97 kg |



* Dependiendo del estado de la almendra

PELADORA G



Peladora de almendra

| | |
|------------|-------------------------------|
| Motor | Motor gasolina Loncin |
| Potencia | 6,5 hp |
| Producción | 750 kg/h * |
| Embalaje | 1.050 x 590 x 1.574 mm |
| Peso | 110 kg |



* Dependiendo del estado de la almendra

APLICACIONES:

Idóneas par el transporte y almacenamiento de la uva

**ENOLOGÍA / Tinajas y accesorios****TINAJAS DE POLIETILENO PE.HD**

| REF | Cap | Ø | Altura | Peso |
|---------|--------------|---------------|---------------|---------------|
| TPE 50 | 50 L | 450 mm | 470 mm | 2,2 kg |
| TPE 75 | 75 L | 480 mm | 570 mm | 3,1 kg |
| TPE 100 | 100 L | 520 mm | 670 mm | 3,9 kg |

**ES - CARACTERÍSTICAS**

Uso enológico alimentario / Imputrescible e inatacable por parásitos
Absolutamente impermeable, no absorbe líquidos.

TAPA NO INCLUIDA

PT - CARACTERÍSTICAS

Uso enológico alimentar / Imputrescível e inatacável por parasitas
Absolutamente impermeável, não absorve líquidos

TAMPA NÃO INCLUIDA

EN - FEATURES

Alimentary oenological use / Rot-proof and invulnerable to parasites
100% waterproof, does not absorb liquids

COVER NOT INCLUDED.

FR - CARACTÉRISTIQUES

Usage œnologique alimentaire Imputrescible et protégé de la vermine
Complètement imperméable n'absorbe pas d'eau

COUVERCLE NON INCLUS

**TAPA**

| REF | Ø | Altura | Peso |
|---------|---------------|--------------|---------------|
| TAT 50 | 460 mm | 30 mm | 0,7 kg |
| TAT 75 | 490 mm | 30 mm | 0,8 kg |
| TAT 100 | 530 mm | 30 mm | 1,0 kg |



GPP 4562 421



Grifo de vaciado

Salida manguera Ø **1"**

Peso **0,3 kg**

ES - CARACTERÍSTICAS

Cierre de esfera sobre asiento de Teflón /
Desmontable
Imputrescible e inatacable por parásitos

PT - CARACTERÍSTICAS

FECH de esfera sobre assento de Teflão /
Desmontável
Imputrescível e inatacável por parasitas

EN - FEATURES

Shut-off ball lock on a Teflon seat /
Detachable
Rot-proof and invulnerable to parasites

FR - CARACTÉRISTIQUES

Fermeture à sphère sur embase de téflon /
Amovible
Imputrescible et protégé de la vermine



FFT 550 204



Filtro de fondo

Medidas A x L x H **176 x 105 x 220 mm**

Peso **0,15 kg**

ES - CARACTERÍSTICAS

Montaje en fondo de tinaja y acoplado al
tubo rosca macho
(Ø 1" c. tuerca) del grifo de vac.

PT - CARACTERÍSTICAS

Montagem no fundo da ânfora e acoplado ao tubo rosca macho (Ø 1" c/ porca) da torneira de esvaziamento

EN - FEATURES

Mounted at the bottom of the large earthenware jar and connected to the male pipe thread (Ø 1" with nut) of the drain tap.

FR - CARACTÉRISTIQUES

Montage au fond d'un pichet couplage au tuyau fileté mâle
(Ø 1" c. écrou) du robinet de vidang.

EMBUDO POLIETILENO C/SOPORTE PARA FILTRO

Uso enológico/alimentario



EMPE 22



Ø (mm) **220**

Peso **0,136 kg**

EMPE 30



Ø (mm) **300**

Peso **0,280 kg**

EMPE 26



Ø (mm) **260**

Peso **0,176 kg**

EMPE 35



Ø (mm) **350**

Peso: **0,285 kg**

FILTROS PARA EMBUDOS

ENOLOGÍA / Accesorios y bidones



FILTEMB 22



Ø **100 mm**
 Peso **0,001 kg**

FILTEMB 26/35



Ø **120 mm**
 Peso **0,002 kg**

APLICACIONES:

Apto para el transporte y almacenamiento de cualquier líquido alimentario, facilitando su vaciado gracias a su grifo de vaciado.



BIDÓN CON GRIFO - FABRICADO EN ELTEX

| REF | Cap | Ø | Altura | Peso |
|------------|--------------|---------------|---------------|----------------|
| BEG 97 010 | 10 L | 220 mm | 330 mm | 0,53 kg |
| BEG 97 020 | 20 L | 290 mm | 410 mm | 0,96 kg |
| BEG 97 025 | 25 L | 320 mm | 430 mm | 1,05 kg |
| BEG 97 050 | 50 L | 390 mm | 560 mm | 1,75 kg |
| BEG 97 100 | 100 L | 490 mm | 710 mm | 3,40 kg |



ES - CARACTERÍSTICAS

Boca Ø int. 9cm y tapa de rosca. Grifo de 1" 1/4. Asa superior metálica abatible.

PT - CARACTERÍSTICAS

Boca Ø int. 9 cm e tampa de rosca. Torneira de 1" 1/4. Pega superior metálica rebatível.

EN - FEATURES

Mouth Ø int. 9cm and screw lid. Tap 1" 1/4. Metallic foldable top handle.

FR - CARACTÉRISTIQUES

Raccord Ø int. 9 cm et couvercle fileté. Robinet 1" 1/4 Poignéesupérieure métallique pliable.





APLICACIONES:

Apto para el transporte y almacenamiento de cualquier líquido alimentario, facilitando su vaciado gracias a su grifo de vaciado.



DEPÓSITO-BIDÓN PARA TRANSPORTE (SOLDADO)

Uso enológico / alimentario

| REF | Cap | Ø Fondo | Altura | Peso | |
|------------|--------------|---------------|---------------|----------------|--|
| DBTR 10 A | 10 L | 304 mm | 234 mm | 2,05 kg |  |
| DBTR 15 A | 15 L | 304 mm | 284 mm | 2,84 kg |  |
| DBTR 20 A | 20 L | 304 mm | 354 mm | 3,5 kg |  |
| DBTR 25 A | 25 L | 304 mm | 424 mm | 4,2 kg |  |
| DBTR 30 A | 30 L | 304 mm | 494 mm | 4,5 kg |  |
| DBTR 50 A | 50 L | 373 mm | 549 mm | 5,4 kg |  |
| DBTR 75 A | 75 L | 373 mm | 779 mm | 6,5 kg |  |
| DBTR 100 A | 100 L | 464 mm | 697 mm | 7,08 kg |  |

ES - CARACTERÍSTICAS

Tapa superior de rosca ø 210 / 2 Asas / Racor soldado para grifo 1/2"
Fabricados en inox AISI 304 BA 18/10 con normativa CE para uso alimentario.

SIN GRIFO

PT - CARACTERÍSTICAS

Tampa superior de rosca ø 210 / 2 Pegas
Racor soldado para torneira 1/2"
Fabricados em inox AISI 304 BA 18/10 com regulamento CE para uso alimentario.

SEM TORNEIRA

EN - FEATURES

Top screw lid ø 210 / 2 handles / Welded fitting for taps 1/2"
Built in AISI 304 BA 18/10 stainless steel with EC regulations for alimentary use.
WITHOUT TAP

FR - CARACTÉRISTIQUES

Couvercle supérieur fileté ø 210 / 2 poignées / Raccord soudé pour robinet 1/2"
Fabriqués en acier inoxydable AISI 304 BA 18/10 conformes à la norme CE de contactalimentaire
SANS ROBINET

APLICACIONES:

Apto para el transporte y almacenamiento de cualquier líquido alimentario, facilitando su vaciado gracias a su grifo de vaciado.

ENOLOGÍA / Depósitos

DEPÓSITO-BIDÓN PARA TRANSPORTE (AGRAFADO)

Uso enológico / alimentario

| REF | Cap | Ø | Altura | Peso |
|--------------|--------------|---------------|---------------|----------------|
| DBTR 15 AGR | 15 L | 300 mm | 300 mm | 2,48 kg |
| DBTR 25 AGR | 25 L | 300 mm | 440 mm | 4,20 kg |
| DBTR 30 AGR | 30 L | 300 mm | 505 mm | 4,50 kg |
| DBTR 50 AGR | 50 L | 370 mm | 570 mm | 5,40 kg |
| DBTR 75 AGR | 75 L | 370 mm | 790 mm | 6,80 kg |
| DBTR 100 AGR | 100 L | 455 mm | 725 mm | 7,08 kg |

ES - CARACTERÍSTICAS

Tapa superior de rosca ø 210 / 2 Asas / Racor soldado para grifo 1/2"
Fabricados en inox AISI 304 BA 18/10 con normativa CE para uso alimentario.

SIN GRIFO

PT - CARACTERÍSTICAS

Tampa superior de rosca ø 210 / 2 Pegas
Racor soldado para torneira 1/2"
Fabricados em inox AISI 304 BA 18/10 com regulamento CE para uso alimentario.

SEM TORNEIRA

EN - FEATURES

Top screw lid ø 210 / 2 handles / Welded fitting for taps 1/2"
Built in AISI 304 BA 18/10 stainless steel with EC regulations for alimentary use.

WITHOUT TAP

FR - CARACTÉRISTIQUES

Couvercle supérieur fileté ø 210 / 2 poignées / Raccord soudé pour robinet 1/2
Fabriqués en acier inoxydable AISI 304 BA 18/10 conformes à la norme CE de contactalimentaire

SANS ROBINET

GRIFOS

GRIFO 1/2 " L ECON

Grifo latón

Ø salida

1/2"

Peso

0,5 kg

GRIFO 1/2 "INOX A

Grifo INOX

Ø salida

1/2"

Peso

0,6 kg

ENOLOGÍA / Depósitos



DEPÓSITOS FLOREADOS INOX 304 E SERIE "ECO"

Depósitos siempre llenos con cierre neumático o con cierre de aceite.

| DEPÓSITO | Ø | ALTURA | CAP | GRIFO | VÁLVULA |
|-----------------------|-------------------------|--------------------------|--------------|--------------------------|-------------------|
| DEP 100 FLOR ECON | 455 mm | 680 mm | 100 L | 1/2" | - |
| EQP. CIERRE NEUMÁTICO | TAPA | CÁMARA | BOMBÍN | GRIFO | VÁLVULA |
| REFERENCIA: | TN 437 | RA437 | O0500 | GRIFO 1/2" L ECON | VAL 1" 1/4 |
| EQP. CIERRE ACEITE | TAPA ACEITE | TAPA POLVO | - | GRIFO | - |
| REFERENCIA: | TAC 100/150A ECO | TAP 100/150A ECON | - | GRIFO 1/2" L ECON | - |
| DEPÓSITO | Ø | ALTURA | CAP | GRIFO | VÁLVULA |
| DEP 150 A FLOR ECON | 455 mm | 965 mm | 150 L | 1/2" | - |
| EQP. CIERRE NEUMÁTICO | TAPA | CÁMARA | BOMBÍN | GRIFO | VÁLVULA |
| REFERENCIA: | TN 437 | RA437 | O0500 | GRIFO 1/2" L ECON | VAL 1" 1/4 |
| EQP. CIERRE ACEITE | TAPA ACEITE | TAPA POLVO | - | GRIFO | - |
| REFERENCIA: | TAC 100/150A ECO | TAP 100/150A ECON | - | GRIFO 1/2" L ECON | - |
| DEPÓSITO | Ø | ALTURA | CAP | GRIFO | VÁLVULA |
| DEP 200 A FLOR ECO | 530 mm | 980 mm | 200 L | 1/2" | - |
| EQP. CIERRE NEUMÁTICO | TAPA | CÁMARA | BOMBÍN | GRIFO | VÁLVULA |
| REFERENCIA: | TN 520 | RA520 | O0500 | GRIFO 1/2" L ECON | VAL 1" 1/4 |
| EQP. CIERRE ACEITE | TAPA ACEITE | TAPA POLVO | - | GRIFO | - |
| REFERENCIA: | TAC 150B/200A | TAP 150B/200A | - | GRIFO 1/2" L ECON | - |
| DEPÓSITO | Ø | ALTURA | CAP | GRIFO | VÁLVULA |
| DEP 200 B FLOR ECO | 630 mm | 690 mm | 200 L | 1/2" | - |
| EQP. CIERRE NEUMÁTICO | TAPA | CÁMARA | BOMBÍN | GRIFO | VÁLVULA |
| REFERENCIA: | TN 610 | RA610 | O0500 | GRIFO 1/2" L ECON | VAL 1" 1/4 |
| EQP. CIERRE ACEITE | TAPA ACEITE | TAPA POLVO | - | GRIFO | - |
| REFERENCIA: | TAC 200/300 ECON | TAP 200/300 ECON | - | GRIFO 1/2" L ECON | - |

APLICACIONES:

Perfecto para la fermentación, elaboración y conservación de vinos.

**ENOLOGÍA / Depósitos****DEPÓSITOS FLOREADOS INOX 304 E SERIE "ECO"**

Depósitos siempre llenos con cierre neumático o con cierre de aceite.

| DEPÓSITO | Ø | ALTURA | CAP | GRIFO | VÁLVULA |
|----------|---|--------|-----|-------|---------|
|----------|---|--------|-----|-------|---------|

| | | | | | |
|-------------------|---------------|---------------|--------------|-------------|---|
| DEP 300 FLOR ECON | 630 mm | 990 mm | 300 L | 3/4" | - |
|-------------------|---------------|---------------|--------------|-------------|---|

| | | | | | |
|-----------------------|------|--------|--------|-------|---------|
| EQP. CIERRE NEUMÁTICO | TAPA | CÁMARA | BOMBÍN | GRIFO | VÁLVULA |
|-----------------------|------|--------|--------|-------|---------|

| | | | | | |
|-------------|---------------|--------------|--------------|--------------------------|-------------------|
| REFERENCIA: | TN 610 | RA610 | O0500 | GRIFO 3/4" L ECON | VAL 1" 1/4 |
|-------------|---------------|--------------|--------------|--------------------------|-------------------|

| | | | | | |
|--------------------|-------------|------------|---|-------|---|
| EQP. CIERRE ACEITE | TAPA ACEITE | TAPA POLVO | - | GRIFO | - |
|--------------------|-------------|------------|---|-------|---|

| | | | | | |
|-------------|-------------------------|-------------------------|---|--------------------------|---|
| REFERENCIA: | TAC 200/300 ECON | TAP 200/300 ECON | - | GRIFO 3/4" L ECON | - |
|-------------|-------------------------|-------------------------|---|--------------------------|---|

| DEPÓSITO | Ø | ALTURA | CAP | GRIFO | VÁLVULA |
|----------|---|--------|-----|-------|---------|
|----------|---|--------|-----|-------|---------|

| | | | | | |
|-------------------|---------------|-----------------|--------------|-------------|---|
| DEP 400 FLOR ECON | 710 mm | 1.045 mm | 400 L | 3/4" | - |
|-------------------|---------------|-----------------|--------------|-------------|---|

| | | | | | |
|-----------------------|------|--------|--------|-------|---------|
| EQP. CIERRE NEUMÁTICO | TAPA | CÁMARA | BOMBÍN | GRIFO | VÁLVULA |
|-----------------------|------|--------|--------|-------|---------|

| | | | | | |
|-------------|---------------|--------------|--------------|--------------------------|-------------------|
| REFERENCIA: | TN 695 | RA695 | O0500 | GRIFO 3/4" L ECON | VAL 1" 1/4 |
|-------------|---------------|--------------|--------------|--------------------------|-------------------|

| | | | | | |
|--------------------|-------------|------------|---|-------|---|
| EQP. CIERRE ACEITE | TAPA ACEITE | TAPA POLVO | - | GRIFO | - |
|--------------------|-------------|------------|---|-------|---|

| | | | | | |
|-------------|---------------------|---------------------|---|--------------------------|---|
| REFERENCIA: | TAC 400 ECON | TAP 400 ECON | - | GRIFO 3/4" L ECON | - |
|-------------|---------------------|---------------------|---|--------------------------|---|

| DEPÓSITO | Ø | ALTURA | CAP | GRIFO | VÁLVULA |
|----------|---|--------|-----|-------|---------|
|----------|---|--------|-----|-------|---------|

| | | | | | |
|-------------------|---------------|-----------------|--------------|-------------|---|
| DEP 500 FLOR ECON | 780 mm | 1.100 mm | 500 L | 3/4" | - |
|-------------------|---------------|-----------------|--------------|-------------|---|

| | | | | | |
|-----------------------|------|--------|--------|-------|---------|
| EQP. CIERRE NEUMÁTICO | TAPA | CÁMARA | BOMBÍN | GRIFO | VÁLVULA |
|-----------------------|------|--------|--------|-------|---------|

| | | | | | |
|-------------|---------------|--------------|--------------|--------------------------|-------------------|
| REFERENCIA: | TN 770 | RA770 | O0500 | GRIFO 3/4" L ECON | VAL 1" 1/4 |
|-------------|---------------|--------------|--------------|--------------------------|-------------------|

| | | | | | |
|--------------------|-------------|------------|---|-------|---|
| EQP. CIERRE ACEITE | TAPA ACEITE | TAPA POLVO | - | GRIFO | - |
|--------------------|-------------|------------|---|-------|---|

| | | | | | |
|-------------|-------------------------|-------------------------|---|--------------------------|---|
| REFERENCIA: | TAC 500/600 ECON | TAP 500/600 ECON | - | GRIFO 3/4" L ECON | - |
|-------------|-------------------------|-------------------------|---|--------------------------|---|

| DEPÓSITO | Ø | ALTURA | CAP | GRIFO | VÁLVULA |
|----------|---|--------|-----|-------|---------|
|----------|---|--------|-----|-------|---------|

| | | | | | |
|-------------------|---------------|-----------------|--------------|-----------|---|
| DEP 600 FLOR ECON | 780 mm | 1.240 mm | 600 L | 1" | - |
|-------------------|---------------|-----------------|--------------|-----------|---|

| | | | | | |
|-----------------------|------|--------|--------|-------|---------|
| EQP. CIERRE NEUMÁTICO | TAPA | CÁMARA | BOMBÍN | GRIFO | VÁLVULA |
|-----------------------|------|--------|--------|-------|---------|

| | | | | | |
|-------------|---------------|--------------|--------------|-------------------|-------------------|
| REFERENCIA: | TN 770 | RA770 | O0500 | GRIFO L 1" | VAL 1" 1/4 |
|-------------|---------------|--------------|--------------|-------------------|-------------------|

| | | | | | |
|--------------------|-------------|------------|---|-------|---|
| EQP. CIERRE ACEITE | TAPA ACEITE | TAPA POLVO | - | GRIFO | - |
|--------------------|-------------|------------|---|-------|---|

| | | | | | |
|-------------|-------------------------|-------------------------|---|-------------------|---|
| REFERENCIA: | TAC 500/600 ECON | TAP 500/600 ECON | - | GRIFO L 1" | - |
|-------------|-------------------------|-------------------------|---|-------------------|---|

| DEPÓSITO | Ø | ALTURA | CAP | GRIFO | VÁLVULA |
|----------|---|--------|-----|-------|---------|
|----------|---|--------|-----|-------|---------|

| | | | | | |
|--------------------|----------------|-----------------|---------------|-----------|---|
| DEP 1000 FLOR ECON | 1025 mm | 1.240 mm | 1000 L | 1" | - |
|--------------------|----------------|-----------------|---------------|-----------|---|

| | | | | | |
|-----------------------|------|--------|--------|-------|---------|
| EQP. CIERRE NEUMÁTICO | TAPA | CÁMARA | BOMBÍN | GRIFO | VÁLVULA |
|-----------------------|------|--------|--------|-------|---------|

| | | | | | |
|-------------|---------------|--------------|--------------|-------------------|-------------------|
| REFERENCIA: | TN 990 | RA990 | O0500 | GRIFO L 1" | VAL 1" 1/4 |
|-------------|---------------|--------------|--------------|-------------------|-------------------|

| | | | | | |
|--------------------|-------------|------------|---|-------|---|
| EQP. CIERRE ACEITE | TAPA ACEITE | TAPA POLVO | - | GRIFO | - |
|--------------------|-------------|------------|---|-------|---|

| | | | | | |
|-------------|----------------------|----------------------|---|-------------------|---|
| REFERENCIA: | TAC 1000 ECON | TAP 1000 ECON | - | GRIFO L 1" | - |
|-------------|----------------------|----------------------|---|-------------------|---|

APLICACIONES:

Perfecto para la fermentación, elaboración y conservación de vinos o cualquier tipo de líquidos alimentarios, sidra, licores, aguardientes, miel, agua, etc.



DEPÓSITOS FLOREADOS INOX 304

Depósitos siempre llenos con cierre neumático o con cierre de aceite.

| DEPÓSITO | Ø | ALTURA | CAP | GRIFO | VÁLVULA |
|-----------------------|-------------------------|-------------------------|--------------|-------------------|-------------------|
| DEP 230 FLOR | 620 mm | 820 mm | 230 L | 1" | - |
| EQP. CIERRE NEUMÁTICO | TAPA | CÁMARA | BOMBÍN | GRIFO | VÁLVULA |
| REFERENCIA: | TN 595 | RA595 | O0500 | GRIFO L 1" | VAL 1" 1/4 |
| EQP. CIERRE ACEITE | TAPA ACEITE | TAPA POLVO | - | GRIFO | - |
| REFERENCIA: | TAC 200/300 ECON | TAP 200/300 ECON | - | GRIFO L 1" | - |
| DEPÓSITO | Ø | ALTURA | CAP | GRIFO | VÁLVULA |
| DEP 330 FLOR | 620 mm | 1.160 mm | 330 L | 1" | - |
| EQP. CIERRE NEUMÁTICO | TAPA | CÁMARA | BOMBÍN | GRIFO | VÁLVULA |
| REFERENCIA: | TN 595 | RA595 | O0500 | GRIFO L 1" | VAL 1" 1/4 |
| EQP. CIERRE ACEITE | TAPA ACEITE | TAPA POLVO | - | GRIFO | - |
| REFERENCIA: | TAC 200/300 ECON | TAP 200/300 ECON | - | GRIFO L 1" | - |
| DEPÓSITO | Ø | ALTURA | CAP | GRIFO | VÁLVULA |
| DEP 420 FLOR | 750 mm | 1.020 mm | 420 L | 1" | - |
| EQP. CIERRE NEUMÁTICO | TAPA | CÁMARA | BOMBÍN | GRIFO | VÁLVULA |
| REFERENCIA: | TN 720 | RA720 | O0500 | GRIFO L 1" | VAL 1" 1/4 |
| EQP. CIERRE ACEITE | TAPA ACEITE | TAPA POLVO | - | GRIFO | - |
| REFERENCIA: | TAC 420/530/640 | TAP 420/530/640 | - | GRIFO L 1" | - |
| DEPÓSITO | Ø | ALTURA | CAP | GRIFO | VÁLVULA |
| DEP 530 FLOR | 750 mm | 1.270 mm | 530 L | 1" | - |
| EQP. CIERRE NEUMÁTICO | TAPA | CÁMARA | BOMBÍN | GRIFO | VÁLVULA |
| REFERENCIA: | TN 720 | RA720 | O0500 | GRIFO L 1" | VAL 1" 1/4 |
| EQP. CIERRE ACEITE | TAPA ACEITE | TAPA POLVO | - | GRIFO | - |
| REFERENCIA: | TAC 420/530/640 | TAP 420/530/640 | - | GRIFO L 1" | - |

APLICACIONES:

Perfecto para la fermentación, elaboración y conservación de vinos o cualquier tipo de líquidos alimentarios, sidra, licores, aguardientes, miel, agua, etc.

**ENOLOGÍA / Depósitos**

| DEPÓSITO | Ø | ALTURA | CAP | GRIFO | VÁLVULA |
|-----------------------|---------------------|---------------------|--------------|-------------------|-------------------|
| DEP 800 FLOR | 940 mm | 1.520 mm | 800 L | 1" | |
| EQP. CIERRE NEUMÁTICO | TAPA | CÁMARA | BOMBÍN | GRIFO | VÁLVULA |
| REFERENCIA: | TN 915 | RA915 | O0500 | GRIFO L 1" | VAL 1" 1/4 |
| EQP. CIERRE ACEITE | TAPA ACEITE | TAPA POLVO | - | GRIFO | - |
| REFERENCIA: | TAC 800/1000 | TAP 800/1000 | - | GRIFO L 1" | - |

DEPÓSITOS FLOREADOS INOX 316

Depósitos siempre llenos c/cierre neumático o con cierre de aceite.

| DEPÓSITO | Ø | ALTURA | CAP | GRIFO | VÁLVULA |
|-----------------------|-------------------------|-------------------------|--------------|-------------------|-------------------|
| DEP 230 C | 620 mm | 820 mm | 230 L | 1" | - |
| EQP. CIERRE NEUMÁTICO | TAPA | CÁMARA | BOMBÍN | GRIFO | VÁLVULA |
| REFERENCIA: | TN 595 | RA595 | O0500 | GRIFO L 1" | VAL 1" 1/4 |
| EQP. CIERRE ACEITE | TAPA ACEITE | TAPA POLVO | - | GRIFO | - |
| REFERENCIA: | TAC 200/300 ECON | TAP 200/300 ECON | - | GRIFO L 1" | - |

| DEPÓSITO | Ø | ALTURA | CAP | GRIFO | VÁLVULA |
|-----------------------|------------------------|------------------------|--------------|-------------------|-------------------|
| DEP 420 C | 750 mm | 1.020 mm | 420 L | 1" | - |
| EQP. CIERRE NEUMÁTICO | TAPA | CÁMARA | BOMBÍN | GRIFO | VÁLVULA |
| REFERENCIA: | TN 720 | RA720 | O0500 | GRIFO L 1" | VAL 1" 1/4 |
| EQP. CIERRE ACEITE | TAPA ACEITE | TAPA POLVO | - | GRIFO | - |
| REFERENCIA: | TAC 420/530/640 | TAP 420/530/640 | - | GRIFO L 1" | - |

| DEPÓSITO | Ø | ALTURA | CAP | GRIFO | VÁLVULA |
|-----------------------|------------------------|------------------------|--------------|-------------------|-------------------|
| DEP 530 C | 750 mm | 1.270 mm | 530 L | 1" | - |
| EQP. CIERRE NEUMÁTICO | TAPA | CÁMARA | BOMBÍN | GRIFO | VÁLVULA |
| REFERENCIA: | TN 720 | RA720 | O0500 | GRIFO L 1" | VAL 1" 1/4 |
| EQP. CIERRE ACEITE | TAPA ACEITE | TAPA POLVO | - | GRIFO | - |
| REFERENCIA: | TAC 420/530/640 | TAP 420/530/640 | - | GRIFO L 1" | - |

APLICACIONES:

Perfecto para la fermentación, elaboración y conservación de vinos o cualquier tipo de líquidos alimentarios, sidra, licores, aguardientes, miel, agua, etc.

TRÍPODE PARA DEPÓSITOS SERIE ECO ACERO INOX

| REF | Diámetro | Altura |
|-------------------|-----------------|---------------|
| PIE 100/150A ECO | 455 mm | 400 mm |
| PIE 150B/200A ECO | 530 mm | 400 mm |
| PIE 200B/300 ECO | 630 mm | 400 mm |
| PIE 400 ECO | 710 mm | 400 mm |
| PIE 500/600 ECO | 780 mm | 400 mm |
| PIE 1000 ECO | 1.025 mm | 400 mm |



DEPÓSITOS FLOREADOS INOX C/FONDO CÓNICO Y PATAS 304

Depósitos siempre llenos con cierre neumático o cierre aceite

| DEPÓSITO | Ø | ALTURA | CAP | GRIFO | VÁLVULA | - |
|-----------------------|-------------------------|--------------------------|--------------|--------------------------|-------------------|----------------------------|
| DEP 100 FLOR FCPS | 470 mm | 1000 mm | 100 L | 1/2" | - | - |
| EQP. CIERRE NEUMÁTICO | TAPA | CÁMARA | BOMBÍN | GRIFO | VÁLVULA | VÁLVULA ESFÉRICA |
| REFERENCIA: | TN 420 | RA420 | O0500 | GRIFO 1/2" L ECON | VAL 1" 1/4 | LIMPIADOR IMPUREZAS |
| EQP. CIERRE ACEITE | TAPA ACEITE | TAPA POLVO | - | GRIFO | - | VÁLVULA ESFÉRICA |
| REFERENCIA: | - | TAP 100/150A ECON | - | GRIFO 1/2" L ECON | - | LIMPIADOR IMPUREZAS |
| DEPÓSITO | Ø | ALTURA | CAP | GRIFO | VÁLVULA | - |
| DEP 230 FLOR FCPS | 620 mm | 1000 mm | 230 L | 1" | - | - |
| EQP. CIERRE NEUMÁTICO | TAPA | CÁMARA | BOMBÍN | GRIFO | VÁLVULA | VÁLVULA ESFÉRICA |
| REFERENCIA: | TN 595 | RA595 | O0500 | GRIFO L 1" | VAL 1" 1/4 | LIMPIADOR IMPUREZAS |
| EQP. CIERRE ACEITE | TAPA ACEITE | TAPA POLVO | - | GRIFO | - | VÁLVULA ESFÉRICA |
| REFERENCIA: | TAC 200/300 ECON | TAP 200/300 ECON | - | GRIFO L 1" | - | LIMPIADOR IMPUREZAS |
| DEPÓSITO | Ø | ALTURA | CAP | GRIFO | VÁLVULA | - |
| DEP 330 FLOR FCPS | 620 mm | 1.500 mm | 330 L | 1" | - | - |
| EQP. CIERRE NEUMÁTICO | TAPA | CÁMARA | BOMBÍN | GRIFO | VÁLVULA | VÁLVULA ESFÉRICA |
| REFERENCIA: | TN 595 | RA595 | O0500 | GRIFO L 1" | VAL 1" 1/4 | LIMPIADOR IMPUREZAS |
| EQP. CIERRE ACEITE | TAPA ACEITE | TAPA POLVO | - | GRIFO | - | VÁLVULA ESFÉRICA |
| REFERENCIA: | TAC 200/300 ECON | TAP 200/300 ECON | - | GRIFO L 1" | - | LIMPIADOR IMPUREZAS |

APLICACIONES:

Perfecto para la fermentación, elaboración y conservación de vinos o cualquier tipo de líquidos alimentarios, sidra, licores, aguardientes, miel, agua, etc.

**ENOLOGÍA / Depósitos**

| DEPÓSITO | Ø | ALTURA | CAP | GRIFO | VÁLVULA | - |
|-----------------------|------------------------|------------------------|---------------|-------------------|-------------------|----------------------------|
| DEP 420 FLOR FCPS | 750 mm | 1.400 mm | 530 L | 1" | - | - |
| EQP. CIERRE NEUMÁTICO | TAPA | CÁMARA | BOMBÍN | GRIFO | VÁLVULA | VÁLVULA ESFÉRICA |
| REFERENCIA: | TN 720 | RA720 | O0500 | GRIFO L 1" | VAL 1" 1/4 | LIMPIADOR IMPUREZAS |
| EQP. CIERRE ACEITE | TAPA ACEITE | TAPA POLVO | - | GRIFO | - | VÁLVULA ESFÉRICA |
| REFERENCIA: | TAC 420/530/640 | TAP 420/530/640 | - | GRIFO L 1" | - | LIMPIADOR IMPUREZAS |
| DEPÓSITO | Ø | ALTURA | CAP | GRIFO | VÁLVULA | - |
| DEP 530 FLOR FCPS | 750 mm | 1.650 mm | 530 L | 1" | - | - |
| EQP. CIERRE NEUMÁTICO | TAPA | CÁMARA | BOMBÍN | GRIFO | VÁLVULA | VÁLVULA ESFÉRICA |
| REFERENCIA: | TN 720 | RA720 | O0500 | GRIFO L 1" | VAL 1" 1/4 | LIMPIADOR IMPUREZAS |
| EQP. CIERRE ACEITE | TAPA ACEITE | TAPA POLVO | - | GRIFO | - | VÁLVULA ESFÉRICA |
| REFERENCIA: | TAC 420/530/640 | TAP 420/530/640 | - | GRIFO L 1" | - | LIMPIADOR IMPUREZAS |
| DEPÓSITO | Ø | ALTURA | CAP | GRIFO | VÁLVULA | - |
| DEP 1000 FLOR FCPS | 1.020 mm | 1.670 mm | 1000 L | 1" | - | - |
| EQP. CIERRE NEUMÁTICO | TAPA | CÁMARA | BOMBÍN | GRIFO | VÁLVULA | VÁLVULA ESFÉRICA |
| REFERENCIA: | TN 990 | RA990 | O0500 | GRIFO L 1" | VAL 1" 1/4 | LIMPIADOR IMPUREZAS |
| EQP. CIERRE ACEITE | TAPA ACEITE | TAPA POLVO | - | GRIFO | - | VÁLVULA ESFÉRICA |
| REFERENCIA: | TAC 1000 ECON | TAP 1000 ECON | - | GRIFO L 1" | VAL 1" 1/4 | LIMPIADOR IMPUREZAS |

*H PATAS **400 mm** excepto DEP 1000 FLOR FCPS (**470 mm**)

APLICACIONES:

Perfecto para la fermentación, elaboración y conservación de vinos o cualquier tipo de líquidos alimentarios, sidra, licores, aguardientes, miel, agua, etc.

1



2



DEPÓSITOS CERRADO C/TAPÓN SUPERIOR 1

FABRICACIÓN POR ENCARGO

| REF | Cap | Ø | Altura c patas |
|-----------|--------------|---------------|-----------------|
| DC 50 PS | 50 L | 400 mm | 750 mm |
| DC 100 PS | 100 L | 480 mm | 975 mm |
| DC 150 PS | 150 L | 525 mm | 975 mm |
| DC 250 PS | 250 L | 640 mm | 1.200 mm |



ES - CARACTERÍSTICAS

Deposito cerrado / Con tapón superior con válvula / Tornillo para alcohol / Nivel en 150 y 250 ltrs / Válvula de salida y vaciado total.

PT - CARACTERÍSTICAS

Depósito fechado / Com tampão superior com válvula / Parafuso para álcool / Nivel em 150 e 250 l / Válvula de saída e esvaziamento total

EN - FEATURES

Closed tank / With a top lid with valve / Screw for alcohol / 150 and 250L level / Outlet valve and total draining.

FR - CARACTÉRISTIQUES

Réservoir fermé / Couvercle supérieur avec soupape / Vis pour alcool / Niveau à 150 et 250 l / Clapet de sortie et totale vidange à porte supérieure

DEPÓSITO CERRADO C/PUERTA SUPERIOR 2

FABRICACIÓN POR ENCARGO

| REF | Cap | Ø | Altura c patas |
|--------------|---------------|---------------|-----------------|
| DCTS 100 PS | 100 L | 480 mm | 975 mm |
| DCTS 150 PS | 150 L | 525 mm | 975 mm |
| DCTS 250 PS | 250 L | 640 mm | 1.200 mm |
| DCTS 350 PS | 350 L | 640 mm | 1.450 mm |
| DCTS 550 PS | 550 L | 800 mm | 1.450 mm |
| DCTS 650 PS | 650 L | 800 mm | 1.700 mm |
| DCTS 750 PS | 750 L | 960 mm | 1.650 mm |
| DCTS 1000 PS | 1000 L | 960 mm | 1.900 mm |



ES - CARACTERÍSTICAS

Depósito cerrado c/ puerta superior / Tornillo para alcohol / Nivel Catavinos / Termómetro a partir de 350 ltrs / 2 Válvulas de latón.

PT - CARACTERÍSTICAS

Depósito fechado com tampão superior / Parafuso para álcool / Nivel Copo de prova / Termómetro a partir de 350 l / 2 Válvulas de latão.

EN - FEATURES

Closed tank with upper door / Screw for alcohol / Level Stainless steel wine taster / Thermometer from 350 L / 2 brass valves

FR - CARACTÉRISTIQUES

Réservoir fermé avec porte supérieure / Vis pour alcool / Niveau Taste-vin en acier inoxydable / Thermomètre à partir de 350 l / 2 clapets en laiton.

APLICACIONES:

Perfecto para la fermentación, elaboración y conservación de vinos o cualquier tipo de líquidos alimentarios, sidra, licores, aguardientes, miel, agua, etc.

ENOIL

ENOLOGÍA / Depósitos**DEPÓSITO CERRADO C/PUERTA INFERIOR (Apert. int.)****1****FABRICACIÓN POR ENCARGO**

| REF | Cap | Ø | Altura c patas |
|---------------|----------------|---------------|-----------------|
| DCTII 250 PS | 250 L | 640 mm | 1.200 mm |
| DCTII 350 PS | 350 L | 640 mm | 1.450 mm |
| DCTII 550 PS | 550 L | 800 mm | 1.450 mm |
| DCTII 650 PS | 650 L | 800 mm | 1.700 mm |
| DCTII 750 PS | 750 L | 960 mm | 1.550 mm |
| DCTII 1000 PS | 1.000 L | 960 mm | 1.800 mm |

**ES - CARACTERÍSTICAS**

Depósito cerrado c/ puerta inferior apert. Interior / Nivel / Catavinos / Tapón c/ válvula / Termómetro / 2 Válvulas de latón.

PT - CARACTERÍSTICAS

Depósito fechado com tampão inferior de abertura interior /Nível Copo de prova / Tampão com válvula/ Termómetro / 2 Válvulas de latão.

EN - FEATURES

Closed tank with an internal-opening lower door / Level / Stainless steel wine taster / Upper air relief valve / Thermometer / 2 brass valves.

FR - CARACTÉRISTIQUES

Réservoir fermé à porte inférieur ouvrant vers l'intérieur / Niveau Taste-vin / brancher avec vanne / Thermomètre / 2 clapets en laiton.

DEPÓSITO CERRADO C/PUERTA INFERIOR (Apert. ext.)**2****FABRICACIÓN POR ENCARGO**

| REF | Cap: | Ø | Altura c patas |
|---------------|----------------|---------------|-----------------|
| DCTIE 250 PS | 250 L | 640 mm | 1.200 mm |
| DCTIE 350 PS | 350 L | 640 mm | 1.450 mm |
| DCTIE 550 PS | 550 L | 800 mm | 1.450 mm |
| DCTIE 650 PS | 650 L | 800 mm | 1.700 mm |
| DCTIE 750 PS | 750 L | 960 mm | 1.550 mm |
| DCTIE 1000 PS | 1.000 L | 960 mm | 1.800 mm |

**ES - CARACTERÍSTICAS**

Depósito cerrado c/ puerta inferior de apertura exterior / Nivel Catavinos / Tapón c/ válvula / Termómetro / 2 Válvulas de latón.

PT - CARACTERÍSTICAS

Depósito fechado com tampão inferior de abertura exterior / Nível Copo de prova / Tampão com válvula/ Termómetro / 2 Válvulas de latão.

EN - FEATURES

Closed tank with an external-opening lower door / Level Stainless steel wine taster / Upper air relief valve / Thermometer / 2 brass valves.

FR - CARACTÉRISTIQUES

Réservoir fermé avec à porte inférieur ouvrant vers l'extérieur / Niveau Taste-vin / brancher avec vanne / Thermomètre / 2 clapets en laiton

APLICACIONES:

Perfecto para la fermentación, elaboración y conservación de vinos o cualquier tipo de líquidos alimentarios, sidra, licores, aguardientes, miel, agua, etc.



DEPÓSITO CERRADO 2 PUERTAS 1

FABRICACIÓN POR ENCARGO

Puerta inferior apertura interior

| REF | Cap | Ø | Altura c patas | |
|----------------|----------------|---------------|-----------------|--|
| DCTIIS 250 PS | 250 L | 640 mm | 1.200 mm | |
| DCTIIS 350 PS | 350 L | 640 mm | 1.450 mm | |
| DCTIIS 550 PS | 550 L | 800 mm | 1.450 mm | |
| DCTIIS 650 PS | 650 L | 800 mm | 1.700 mm | |
| DCTIIS 750 PS | 750 L | 960 mm | 1.650 mm | |
| DCTIIS 1000 PS | 1.000 L | 960 mm | 1.900 mm | |

ES - CARACTERÍSTICAS

Depósito cerrado c/ 2 puertas (la puerta inferior de apertura interior)
Nivel / Catavinos / Tapón c/ válvula / Termómetro / 2 Válvulas de latón

PT - CARACTERÍSTICAS

Depósito fechado com 2 tampões (a inferior de abertura interior)
Nível / Copo de prova / Tampão com válvula/ Termómetro / 2 Válvulas de latão.

EN - FEATURES

Closed tank with with 2 doors (The inner lower opening door) / Level
Stainless steel wine taster / lid with valve / Thermometer / 2 brass valves

FR - CARACTÉRISTIQUES

Réservoir fermé avec 2 soupapes (à porte inférieur ouvrant vers l'intérieur) /
Niveau / Taste-vin / brancher avec vanne / Thermomètre /
2 clapets en laiton.

DEPÓSITO CERRADO 2 PUERTAS 2

FABRICACIÓN POR ENCARGO

Puerta inferior apertura exterior

| REF | Cap | Ø | Altura c patas | |
|----------------|----------------|---------------|-----------------|--|
| DCTIES 250 PS | 250 L | 640 mm | 1.200 mm | |
| DCTIES 350 PS | 350 L | 640 mm | 1.450 mm | |
| DCTIES 550 PS | 550 L | 800 mm | 1.450 mm | |
| DCTIES 650 PS | 650 L | 800 mm | 1.700 mm | |
| DCTIES 750 PS | 750 L | 960 mm | 1.650 mm | |
| DCTIES 1000 PS | 1.000 L | 960 mm | 1.900 mm | |



DEPÓSITOS A MEDIDA

Fabricamos una amplia variedad de depósitos cerrados, siempre llenos, con fondo cónico, fondo plano, con y sin camisa...

También a medida y a petición del cliente, para distintos usos y características.
Bajo pedido y según sus necesidades.



APLICACIONES:

Perfecto para la fermentación, elaboración y conservación de vinos o cualquier tipo de líquidos alimentarios, sidra, licores, aguardientes, miel, agua, etc.



DEPÓSITO CERRADO FONDO CÓNICO

Puerta superior e inferior de apertura exterior

| REF | Cap | Ø | Altura c patas | Espesor chapa |
|-------------------|----------|----------|----------------|---------------|
| DCTIES 1000 FCPS | 1.000 L | 940 mm | 1.500 mm | 2 mm |
| DCTIES 1500 FCPS | 1.500 L | 1.155 mm | 1.500 mm | 2 mm |
| DCTIES 2000 FCPS | 2.000 L | 1.325 mm | 1.500 mm | 2 mm |
| DCTIES 2500 FCPS | 2.500 L | 1.275 mm | 2.000 mm | 2 mm |
| DCTIES 3000 FCPS | 3.000 L | 1.405 mm | 2.000 mm | 2 mm |
| DCTIES 4000 FCPS | 4.000 L | 1.605 mm | 2.000 mm | 2 mm |
| DCTIES 5000 FCPS | 5.000 L | 1.845 mm | 2.000 mm | 2 mm |
| DCTIES 10000 FCPS | 10.000 L | 2.100 mm | 3.000 mm | 2/2,5 mm |

ES - CARACTERÍSTICAS

Nivel con grifo inox / Catavinos inox / Termómetro inox / 2 Válvulas de mariposa DIN50 / Válvula de desaire superior inox

PT - CARACTERÍSTICAS

Nível com torneira inox / Copo de prova inox / Termómetro inox / 2 Válvulas de borboleta DIN50 / Válvula de extração de ar superior inox.

EN - FEATURES

Stainless steel tap level / Stainless steel thermometer / 2 DIN50 butterfly valves / Upper air relief valve.

FR - CARACTÉRISTIQUES

Indicateur de niveau avec robinet en acier inoxydable / Taste-vin en acier inoxydable / Thermomètre en acier inoxydable / 2 clapets à papillon DIN50 / Clapet de décharge supérieure en acier inoxydable.

EQUIPAMIENTO OPCIONAL

PIES REGULABLES

TUBO DE REMONTE

AGITADOR PARA REMONTADO ACERO INOX

TUBO BUSCACLAROS

APLICACIONES:

Perfecto para la fermentación, elaboración y conservación de vinos o cualquier tipo de líquidos alimentarios, sidra, licores, aguardientes, miel, agua, etc.

ENOIL
ENOLOGÍA / Depósitos

DEPÓSITOS CERRADO FONDO CÓNICO/CAMISA

Puerta superior e inferior de apertura exterior

| REF | Cap | Ø | Altura c patas | Espesor chapa |
|-----------------------|-----------------|-----------------|-----------------|-----------------|
| DCTIES 1000 FCPS CAM | 1.000 L | 940 mm | 1.500 mm | 2 mm |
| DCTIES 1500 FCPS CAM | 1.500 L | 1.155 mm | 1.500 mm | 2 mm |
| DCTIES 2000 FCPS CAM | 2.000 L | 1.325 mm | 1.500 mm | 2 mm |
| DCTIES 2500 FCPS CAM | 2.500 L | 1.275 mm | 2.000 mm | 2 mm |
| DCTIES 3000 FCPS CAM | 3.000 L | 1.405 mm | 2.000 mm | 2 mm |
| DCTIES 4000 FCPS CAM | 4.000 L | 1.605 mm | 2.000 mm | 2 mm |
| DCTIES 5000 FCPS CAM | 5.000 L | 1.845 mm | 2.000 mm | 2 mm |
| DCTIES 10000 FCPS CAM | 10.000 L | 2.100 mm | 3.000 mm | 2/2,5 mm |

ES - CARACTERÍSTICAS

Nivel con grifo inox / Catavinos inox / Termómetro inox / 2 Válvulas de mariposa DIN50 / Válvula de desaire superior inox

PT - CARACTERÍSTICAS

Nível com torneira inox / Copo de prova inox / Termómetro inox / 2 Válvulas de borboleta DIN50 / Válvula de extração de ar superior inox.

EN - FEATURES

Stainless steel tap level / Stainless steel thermometer / 2 DIN50 butterfly valves / Upper air relief valve.

FR - CARACTÉRISTIQUES

Indicateur de niveau avec robinet en acier inoxydable / Taste-vin en acier inoxydable / Thermomètre en acier inoxydable / 2 clapets à papillon DIN50 / Clapet de décharge supérieure en acier inoxydable.

EQUIPAMIENTO OPCIONAL

PIES REGULABLES
TUBO DE REMONTE
AGITADOR PARA REMONTADO ACERO INOX
TUBO BUSCACLAROS



APLICACIONES:

Perfecto para la fermentación, elaboración y conservación de vinos o cualquier tipo de líquidos alimentarios, sidra, licores, aguardientes, miel, agua, etc..



DEPÓSITO SIEMPRE LLENO FONDO CÓNICO

Con cierre completo de aire

| REF | Cap | Ø | Altura c patas | Espesor chapa |
|----------------|----------------|-----------------|-----------------|---------------|
| DSLL 1000 FCPS | 1.000 L | 940 mm | 1.500 mm | 2 mm |
| DSLL 1500 FCPS | 1.500 L | 1.155 mm | 1.500 mm | 2 mm |
| DSLL 2000 FCPS | 2.000 L | 1.325 mm | 1.500 mm | 2 mm |
| DSLL 2500 FCPS | 2.500 L | 1.275 mm | 2.000 mm | 2 mm |
| DSLL 3000 FCPS | 3.000 L | 1.405 mm | 2.000 mm | 2 mm |
| DSLL 4000 FCPS | 4.000 L | 1.605 mm | 2.000 mm | 2 mm |
| DSLL 5000 FCPS | 5.000 L | 1.845 mm | 2.000 mm | 2 mm |

ES - CARACTERÍSTICAS

Puerta inferior de apertura exterior / Brazo para elevación de tapa neumática / Nivel inox con grifo / Catavinos inox / Termómetro / 2 Válvulas de Mariposa DIN50

PT - CARACTERÍSTICAS

Porta inferior de abertura exterior / Braço para elevação de tampa pneumática / Nivel com torneira inox / Copo de prova inox / Termómetro / 2 Válvulas de borboleta DIN50

EN - FEATURES

Upper door with an external-opening / Lift arm for pneumatic closing lids / Stainless steel tap level / Stainless steel wine taster / Thermometer / 2 DIN50 butterfly valves

FR - CARACTÉRISTIQUES

À porte inférieure ouvrant vers l'extérieur / Flèche pour ouverture pneumatique du couvercle / Niveau en acier inoxydable avec robinet / Taste-vin en acier inoxydable / Thermomètre / 2 clapets à papillon DIN50

EQUIPAMIENTO OPCIONAL

PIES REGULABLES

CARRACA

TUBO BUSCACLAROS

APLICACIONES:

Perfecto para la fermentación, elaboración y conservación de vinos o cualquier tipo de líquidos alimentarios, sidra, licores, aguardientes, miel, agua, etc.



DEPÓSITO SIEMPRE LLENO FONDO CÓNICO/CAMISA

Con cierre completo de aire

| REF | Cap | Ø | Altura c patas | Espesor chapa |
|---------------------|----------|----------|----------------|---------------|
| DSLL 1000 FCPS CAM | 1.000 L | 940 mm | 1.500 mm | 2 mm |
| DSLL 1500 FCPS CAM | 1.500 L | 1.155 mm | 1.500 mm | 2 mm |
| DSLL 2000 FCPS CAM | 2.000 L | 1.325 mm | 1.500 mm | 2 mm |
| DSLL 2500 FCPS CAM | 2.500 L | 1.275 mm | 2.000 mm | 2 mm |
| DSLL 3000 FCPS CAM | 3.000 L | 1.405 mm | 2.000 mm | 2 mm |
| DSLL 4000 FCPS CAM | 4.000 L | 1.605 mm | 2.000 mm | 2 mm |
| DSLL 5000 FCPS CAM | 5.000 L | 1.845 mm | 2.000 mm | 2 mm |
| DSLL 10000 FCPS CAM | 10.000 L | 2.100 mm | 3.000 mm | 2/2,5 mm |

ES - CARACTERÍSTICAS

Puerta inferior de apertura exterior / Cierre completo de aire / Brazo para elevación de tapa neumática / Nivel inox con grifo / Catavinos inox / Termómetro / 2 Válvulas de Mariposa DIN50

PT - CARACTERÍSTICAS

Porta inferior de abertura exterior / encerramento completo de ar
Braço para elevação de tampa pneumática / Nivel com torneira inox / Copo de prova inox / Termómetro / 2 Válvulas de borboleta DIN50

EN - FEATURES

Upper door with an external-opening / full closure of air / Lift arm for pneumatic closing lids / Stainless steel tap level / Stainless steel wine taster / Thermometer / 2 DIN50 butterfly valves

FR - CARACTÉRISTIQUES

À porte inférieur ouvrant vers l'extérieur / fermeture complète de l'air / Flèche pour ouverture pneumatique du couvercle / Niveau en acier inoxydable avec robinet / Taste-vin en acier inoxydable / Thermomètre / 2 clapets à papillon DIN50

EQUIPAMIENTO OPCIONAL

PIES REGULABLES

CARRACA

TUBO BUSCACLAROS

APLICACIONES:

Perfecto para la fermentación, elaboración y conservación de vinos o cualquier tipo de líquidos alimentarios, sidra, licores, aguardientes, miel, agua, etc.



DEPÓSITO CERRADO FONDO PLANO INCLINADO 5%

Con puerta superior e inferior de apertura exterior

| REF | Cap | Ø | Altura c patas | Espesor chapa |
|---------------------|-----------------|-----------------|-----------------|-----------------|
| DCTIES 1000 FPI PS | 1.000 L | 940 mm | 1.500 mm | 2 mm |
| DCTIES 1500 FPI PS | 1.500 L | 1.155 mm | 1.500 mm | 2 mm |
| DCTIES 2000 FPI PS | 2.000 L | 1.325 mm | 1.500 mm | 2 mm |
| DCTIES 2500 FPI PS | 2.500 L | 1.275 mm | 2.000 mm | 2 mm |
| DCTIES 3000 FPI PS | 3.000 L | 1.405 mm | 2.000 mm | 2 mm |
| DCTIES 4000 FPI PS | 4.000 L | 1.605 mm | 2.000 mm | 2 mm |
| DCTIES 5000 FPI PS | 5.000 L | 1.845 mm | 2.000 mm | 2 mm |
| DCTIES 10000 FPI PS | 10.000 L | 2.100 mm | 3.000 mm | 2/2,5 mm |

ES - CARACTERÍSTICAS

Nivel con grifo inox / Catavinos inox / Termómetro inox / 2 Válvulas de mariposa DIN50 / Válvula de desaire superior inox.

PT - CARACTERÍSTICAS

Nível com torneira inox / Copo de prova inox / Termómetro inox / 2 Válvulas de borboleta DIN50 / Válvula de extração de ar superior inox

EN - FEATURES

Stainless steel tap level / Stainless steel wine taster / Stainless steel thermometer / 2 DIN50 butterfly valves / Upper air relief valve.

FR - CARACTÉRISTIQUES

Niveau en acier inoxydable avec robinet / Taste-vin en acier inoxydable / 2 clapets à papillon DIN50 / Clapet de décharge supérieure en acier inoxydable

EQUIPAMIENTO OPCIONAL

PIES REGULABLES

TUBO DE REMONTE

AGITADOR PARA REMONTADO ACERO INOX

TUBO BUSCACLAROS

CONSULTAR PVP

APLICACIONES:

Perfecto para la fermentación, elaboración y conservación de vinos o cualquier tipo de líquidos alimentarios, sidra, licores, aguardientes, miel, agua, etc.



DEPÓSITO CERRADO FONDO PLANO INCLINADO 5% /CAMISA

Con puerta superior e inferior de apertura exterior

| REF | Cap | Ø | Altura c patas | Espesor chapa |
|-------------------------|-----------------|-----------------|-----------------|-----------------|
| DCTIES 1000 FPI PS CAM | 1.000 L | 940 mm | 1.500 mm | 2 mm |
| DCTIES 1500 FPI PS CAM | 1.500 L | 1.155 mm | 1.500 mm | 2 mm |
| DCTIES 2000 FPI PS CAM | 2.000 L | 1.325 mm | 1.500 mm | 2 mm |
| DCTIES 2500 FPI PS CAM | 2.500 L | 1.275 mm | 2.000 mm | 2 mm |
| DCTIES 3000 FPI PS CAM | 3.000 L | 1.405 mm | 2.000 mm | 2 mm |
| DCTIES 4000 FPI PS CAM | 4.000 L | 1.605 mm | 2.000 mm | 2 mm |
| DCTIES 5000 FPI PS CAM | 5.000 L | 1.845 mm | 2.000 mm | 2 mm |
| DCTIES 10000 FPI PS CAM | 10.000 L | 2.100 mm | 3.000 mm | 2/2,5 mm |

ES - CARACTERÍSTICAS

Nivel con grifo inox / Catavinos inox / Termómetro inox / 2 Válvulas de mariposa DIN50 / Válvula de desaire superior inox.

PT - CARACTERÍSTICAS

Nível com torneira inox / Copo de prova inox / Termómetro inox / 2 Válvulas de borboleta DIN50 / Válvula de extração de ar superior inox.

EN - FEATURES

Stainless steel tap level / Stainless steel wine taster / Stainless steel thermometer / 2 DIN50 butterfly valves / Upper air relief valve.

FR - CARACTÉRISTIQUES

Niveau en acier inoxydable avec robinet / Taste-vin en acier inoxydable / 2 clapets à papillon DIN50 / Clapet de décharge supérieure en acier inoxydable

EQUIPAMIENTO OPCIONAL

PIES REGULABLES

TUBO DE REMONTE

AGITADOR PARA REMONTADO ACERO INOX

TUBO BUSCACLAROS

CONSULTAR PVP



APLICACIONES:

Perfecto para la fermentación, elaboración y conservación de vinos o cualquier tipo de líquidos alimentarios, sidra, licores, aguardientes, miel, agua, etc.



DEPÓSITO SIEMPRE LLENO FONDO PLANO INCLINADO

Con cierre completo de aire

| REF | Cap | Ø | Altura c patas | Espesor chapa |
|------------------|----------------|-----------------|-----------------|---------------|
| DSLL 1000 FPI PS | 1.000 L | 940 mm | 1.500 mm | 2 mm |
| DSLL 1500 FPI PS | 1.500 L | 1.155 mm | 1.500 mm | 2 mm |
| DSLL 2000 FPI PS | 2.000 L | 1.325 mm | 1.500 mm | 2 mm |
| DSLL 2500 FPI PS | 2.500 L | 1.275 mm | 2.000 mm | 2 mm |
| DSLL 3000 FPI PS | 3.000 L | 1.405 mm | 2.000 mm | 2 mm |
| DSLL 4000 FPI PS | 4.000 L | 1.605 mm | 2.000 mm | 2 mm |
| DSLL 5000 FPI PS | 5.000 L | 1.845 mm | 2.000 mm | 2 mm |

ES - CARACTERÍSTICAS

Puerta inferior de apertura exterior / Brazo para elevación de tapa neumática / Nivel inox con grifo / Catavinos inox / Termómetro / 2 Válvulas de Mariposa DIN50

PT - CARACTERÍSTICAS

Porta inferior de abertura exterior / Braço para elevação de tampa pneumática / Nível com torneira inox / Copo de prova inox / Termómetro / 2 Válvulas de borboleta DIN50

EN - FEATURES

Upper door with an external-opening / Lift arm for pneumatic closing lids / Stainless steel tap level / Stainless steel wine taster / Thermometer / 2 DIN50 butterfly valves

FR - CARACTÉRISTIQUES

À porte inférieure ouvrant vers l'extérieur / Flèche pour ouverture pneumatique du couvercle / Niveau en acier inoxydable avec robinet / Taste-vin en acier inoxydable / Thermomètre / 2 clapets à papillon DIN50

EQUIPAMIENTO OPCIONAL

PIES REGULABLES
TUBO DE REMONTE
CARRACA

CONSULTAR PVP

APLICACIONES:

Perfecto para la fermentación, elaboración y conservación de vinos o cualquier tipo de líquidos alimentarios, sidra, licores, aguardientes, miel, agua, etc.



DEPÓSITO SIEMPRE LLENO FONDO PLANO INCLINADO/CAMISA

Con cierre completo de aire

| REF | Cap | Ø | Altura c patas | Espesor chapa |
|-----------------------|-----------------|-----------------|-----------------|-----------------|
| DSLL 1000 FPI PS CAM | 1.000 L | 940 mm | 1.500 mm | 2 mm |
| DSLL 1500 FPI PS CAM | 1.500 L | 1.155 mm | 1.500 mm | 2 mm |
| DSLL 2000 FPI PS CAM | 2.000 L | 1.325 mm | 1.500 mm | 2 mm |
| DSLL 2500 FPI PS CAM | 2.500 L | 1.275 mm | 2.000 mm | 2 mm |
| DSLL 3000 FPI PS CAM | 3.000 L | 1.405 mm | 2.000 mm | 2 mm |
| DSLL 4000 FPI PS CAM | 4.000 L | 1.605 mm | 2.000 mm | 2 mm |
| DSLL 5000 FPI PS CAM | 5.000 L | 1.845 mm | 2.000 mm | 2 mm |
| DSLL 10000 FPI PS CAM | 10.000 L | 2.100 mm | 3.000 mm | 2/2,5 mm |

ES - CARACTERÍSTICAS

Puerta inferior de apertura exterior / Brazo para elevación de tapa neumática / Nivel inox con grifo / Catavinos inox / Termómetro / 2 Válvulas de Mariposa DIN50

PT - CARACTERÍSTICAS

Porta inferior de abertura exterior / Braço para elevação de tampa pneumática / Nível com torneira inox / Copo de prova inox / Termómetro / 2 Válvulas de borboleta DIN50

EN - FEATURES

Upper door with an external-opening / Lift arm for pneumatic closing lids / Stainless steel tap level / Stainless steel wine taster / Thermometer / 2 DIN50 butterfly valves

FR - CARACTÉRISTIQUES

La porte inférieur ouvrant vers l'extérieur / Flèche pour ouverture pneumatique du couvercle / Niveau en acier inoxydable avec robi net / Teste-vin en acier inoxydable / Thermomètre / 2 clapets à papillon DIN50







EQUIPAMIENTO OPCIONAL

PIES REGULABLES
TUBO DE REMONTE
CARRACA









CONSULTAR PVP



TAPA DE ACEITE 1

| REF | Ø | |
|------------------|---------------|---|
| TAC 100/150A ECO | 430 mm |  |
| TAC 150B/200A | 520 mm |  |
| TAC 200/300 ECON | 610 mm |  |
| TAC 400 ECON | 695 mm |  |
| TAC 420/530/640 | 720 mm |  |
| TAC 500/600 ECON | 770 mm |  |
| TAC 800/1000 | 915 mm |  |
| TAC 1000 ECON | 990 mm |  |

TAPA DE POLVO 2

| REF | Ø | |
|-------------------|-----------------|---|
| TAP 65/100 | 470 mm |  |
| TAP 100/150A ECON | 485 mm |  |
| TAP 150B/200A | 550 mm |  |
| TAP 200/300 ECON | 660 mm |  |
| TAP 400 ECON | 710 mm |  |
| TAP 420/530/640 | 770 mm |  |
| TAP 500/600 ECON | 810 mm |  |
| TAP 800/1000 | 970 mm |  |
| TAP 1000 ECON | 1.060 mm |  |



TAPA NEUMÁTICA

| REF | Ø | |
|---------|----------------|--|
| TN 380 | 380 mm | |
| TN 420 | 420 mm | |
| TN 437 | 437 mm | |
| TN 480 | 480 mm | |
| TN 520 | 520 mm | |
| TN 595 | 595 mm | |
| TN 610 | 610 mm | |
| TN 695 | 695 mm | |
| TN 720 | 720 mm | |
| TN 770 | 770 mm | |
| TN 915 | 915 mm | |
| TN 990 | 990 mm | |
| TN 1125 | 1125 mm | |
| TN 1245 | 1245 mm | |
| TN 1295 | 1295 mm | |
| TN 1375 | 1375 mm | |



CÁMARAS DE PLÁSTICO TRANSPARENTE 1

Uso enológico / alimentario para tapa neumática en depósitos siempre llenos

| REF | Ø | |
|--------|---------|--|
| RA380 | 380 mm | |
| RA420 | 420 mm | |
| RA437 | 437 mm | |
| RA480 | 480 mm | |
| RA520 | 520 mm | |
| RA595 | 595 mm | |
| RA610 | 610 mm | |
| RA635 | 635 mm | |
| RA695 | 695 mm | |
| RA720 | 720 mm | |
| RA735 | 735 mm | |
| RA770 | 770 mm | |
| RA830 | 830 mm | |
| RA915 | 915 mm | |
| RA930 | 930 mm | |
| RA990 | 990 mm | |
| RA1125 | 1125 mm | |
| RA1245 | 1245 mm | |
| RA1295 | 1295 mm | |
| RA1375 | 1375 mm | |
| RA1575 | 1575 mm | |
| RA1725 | 1725 mm | |
| RA1815 | 1815 mm | |
| RA1970 | 1970 mm | |

00500

Bombín para inflado de cámara DSLL



Ø **28 mm**
Peso **0,440 kg**

**VEDE2"**Válvula de expulsión doble efecto.
Para tapa neumática DSLL y depósitos cerrados

Rosca **2"**
Peso **0,90 kg**

**00701**

Bombín para inflado de cámara DSLL



Ø **40 mm**
Peso **0,440 kg**

**VAL 1" 1/4**Válvula de expulsión doble efecto.
Para tapa neumática DSLL y depósitos cerrados

Rosca **1" 1/4**
Peso **0,073 kg**





ENOLOGÍA / Complementos depósitos

O2501



Manómetro para bombín

Rosca

1/4 mm

Peso

0,071 kg



VAL 1"1/2



Válvula de expulsión
doble efecto.
Para tapa neumática
DSLL y depósitos cerrados

Rosca

1" 1/2

Peso

0,073 kg



FA 309092702



Batoque plástico para
depósito rosca 1/2

Peso

0,100 kg



ARS



Polea de levantamiento
para DSLL

Peso

3,5 kg







ENOLOGÍA / Complementos depósitos

1



2



3



GRIFO LATÓN NIQUELADO 1

| REF | Rosca macho Ø |
|-------------------|---------------|
| GRIFO 3/8" L ECON | 3/8" |
| GRIFO 1/2" L ECON | 1/2" |
| GRIFO 3/4" L ECON | 3/4" |
| GRIFO L1" | 1" |



GRIFO ACERO INOXIDABLE 2

| REF | Rosca macho Ø |
|----------------|---------------|
| GRIFO I 3/8" S | 3/8" |
| GRIFO I 1/2" S | 1/2" |
| GRIFO I 3/4" S | 3/4" |
| GRIFO I 1" S | 1" |



GRIFO 1/2" INOX A



| | |
|----------|--------|
| Ø salida | 1/2" |
| Peso | 0,6 kg |

Grifo INOX

VÁLVULA DE ESFERA LATÓN 3

| REF | Rosca macho Ø |
|----------|---------------|
| VEL1.1/4 | 1"1/4 |
| VEL1.1/2 | 1"1/2 |
| VEL2 | 2" |



ENOLOGÍA / Complementos depósitos

1



2



VÁLVULA DE ESFERA ACERO INOXIDABLE

1

| REF | Rosca macho Ø | |
|----------|---------------|--|
| VEI1/2 | 1/2" | |
| VEI3/4 | 3/4" | |
| VEI1.1/4 | 1"1/4 | |
| VEI1.1/2 | 1"1/2 | |



TERW 120D63

Termómetro para depósitos cerrados Ø 63 mm



| | |
|-------------------|-------------|
| Rango temp | 0°C - 120°C |
| Escala graduación | 2° |
| Peso | 0,056 kg |



TD00010

Termómetro para depósitos cerrados Ø 110 mm



| | |
|-------------------|-------------|
| Rango temp | 20°C - 80°C |
| Escala graduación | 2° |
| Peso | 0,300 kg |



ENOLOGÍA / Complementos depósitos

MOS 0982



Mostímetro c/termómetro
se utiliza para obtener el grado de alcohol en el mosto

| | |
|-------------|-----------------|
| Calibración | 15°C |
| Medidas | 330 mm |
| Escala | 2 |
| Peso | 0,195 kg |



REFR PMTC-25



Refractómetro. Se utiliza para medir al instante el porcentaje de azúcar presente en la fruta y así conocer su calidad. 2 escalas Baumé y Vol. No dispone de lectura directa.

| | |
|-----------|-----------------|
| Vol | 0-20% |
| Precisión | 0,2 % |
| Escala | 5 |
| Peso | 0,200 kg |



DEN 1695

Densímetro c/termómetro. Se utiliza para obtener la densidad del mosto y por tanto su grado de fermentación.

| | |
|-------------------|-----------------------|
| Rango temp | -30°C / + 50°C |
| Escala graduación | 1° |
| Medidas | 300x50x14 mm |
| Peso | 0,225 kg |

**ALCO 01672**

Alcoholímetro, se utiliza para determinar el nivel de alcohol que se halla presente en un líquido o gas.

| | |
|---------|-----------------|
| Medidas | 330 mm |
| Peso | 0,195 kg |

**VIN 0986**

Vinómetro, se utiliza para obtener el grado de alcohol en el vino.

| | |
|-------------|-----------------|
| Calibración | 15°C |
| Medidas | 130 mm |
| Peso | 0,200 kg |





APLICACIONES:

Se utiliza para la evaporación y posterior condensación de los acoholes de diferentes mezclas. Los vapores emitidos salen por la parte superior y se enfrían en un serpentín situado en un recipiente refrigerado por agua. El líquido resultante se recoge en el depósito final.



ALAMBIQUES

| REF | Capacidad L | Peso | |
|---------------|-------------|----------------|--|
| ALAMBIQUE 5 | 5 | 1,50 kg | |
| ALAMBIQUE 10 | 10 | 2,60 kg | |
| ALAMBIQUE 15 | 15 | 3 kg | |
| ALAMBIQUE 20 | 20 | 4 kg | |
| ALAMBIQUE 30 | 30 | 6 kg | |
| ALAMBIQUE 40 | 40 | 7 kg | |
| ALAMBIQUE 50 | 50 | 10 kg | |
| ALAMBIQUE 60 | 60 | 12 kg | |
| ALAMBIQUE 80 | 80 | 15 kg | |
| ALAMBIQUE 100 | 100 | 19 kg | |
| ALAMBIQUE 150 | 150 | 28 kg | |
| ALAMBIQUE 200 | 200 | 37,5 kg | |

ES - CARACTERÍSTICAS

Existen más medidas disponibles; todas ellas bajo pedido.

PT - CARACTERÍSTICAS

Existem mais tamanhos disponíveis; todas sob encomenda.

EN - FEATURES

There are more available sizes upon request.

FR - CARACTÉRISTIQUES

Vous disposez d'autres tailles sur commande.

APLICACIONES:

Los filtros como su nombre bien indica se utilizan para el filtrado y clarificación de numerosos líquidos.



FILTRO COLOMBO

*incluye placas filtrantes V4 y V16

FCOLB 6PV

Serie Colombo, filtro de 6 placas con bomba "RP Autoaspirante"



FCOLB 12PV

Serie Colombo, filtro de 12 placas con bomba "RP Autoaspirante"



FCOLB 18PV

Serie Colombo, filtro de 18 placas con bomba "RP Autoaspirante"



| | FCOLB 6PV | FCOLB 12PV | FCOLB 18PV |
|----------------|---------------------------|---------------------------|---------------------------|
| Superficie | 20x20 cm | 20x20 cm | 20x20 cm |
| L.vino/h | 180÷300 | 300÷500 | 400÷700 |
| Potencia motor | M20-0,5 hp | M20-0,5 hp | M20-0,5 hp |
| Embalaje | 360 x 300 x 280 mm | 460 x 300 x 280 mm | 560 x 300 x 280 mm |
| Peso | 17 kg | 18 kg | 19 kg |

PLACAS FILTRANTES 20x20

Placas filtrantes de celulosa 20x20cm (paquetes 25 Uds)



REF **Aplicación**

PF20 V4 **Desbaste**

PF20 V8 **Desbaste fino**

PF20 V12 **Abrilla. medio**

PF20 V16 **Abrillantado**

PF20 V18 **Abrilla. extra**

PF20 V20 **Esterilizante**



*Precio por unidad



APLICACIONES:

Los filtros como su nombre bien indica se utilizan para el filtrado y clarificación de numerosos líquidos.



FILTRO JOLLY

*no incluye placas filtrantes

FABRICACIÓN POR ENCARGO

FJOLB 10PV

Serie Jolly, filtro de 10 placas con bomba "RP Autoaspirante"



FJOLB 20PV

Serie Jolly, filtro de 20 placas con bomba "RP Autoaspirante"



FJOLB 30PV

Serie Jolly, filtro de 30 placas con bomba "RP Autoaspirante"



| | | | |
|----------------|---------------------------|---------------------------|---------------------------|
| Superficie | 20 x 20 cm | 20 x 20 cm | 20 x 20 cm |
| L.vino/h | 300÷500 | 700÷1000 | 1000÷1500 |
| Potencia motor | 0,5 hp | 0,5 hp | 0,8 hp |
| Embalaje | 500 x 400 x 570 mm | 650 x 400 x 570 mm | 800 x 400 x 570 mm |
| Peso | 30 kg | 38 kg | 50 kg |

PLACAS FILTRANTES 40x40

Placas filtrantes de celulosa 40x40cm (paquetes 25 Uds)

| REF | Aplicación | |
|----------|-----------------------|--|
| PF40 V4 | Desbaste | |
| PF40 V8 | Desbaste fino | |
| PF40 V12 | Abrilla. medio | |
| PF40 V16 | Abrillantado | |
| PF40 V18 | Abrilla. extra | |
| PF40 V20 | Esterilizante | |



*Precio por unidad

APLICACIONES:

Idóneas para el trasiego de líquidos filtrados para agricultura, enología, náutica, jardinería...

ENOLOGÍA / Electrobombas

ELECTROBOMBA

Electrobomba autoaspirante bidireccional

M 20CE



M 25CE



M 30CE



| | | | |
|--------------------|---------------------------|--------------------------|---------------------------|
| Monofásica | 200v-50Hz | 200v-50Hz | 200v-50Hz |
| Caudal | 1.700L/H | 2.500L/H | 4.500L/H |
| Vel.giro | 2.850 rpm | 2.850 rpm | 2.850 rpm |
| Potencia absorbida | 0,5 hp | 0,8 hp | 1 hp |
| Ø asp/imp | 20 mm | 25 mm | 30 mm |
| Embalaje | 230 x 120 x 190 mm | 230 x120 x 190 mm | 255 x 160 x 190 mm |
| Peso | 5 kg | 6 kg | 8 kg |

M 40CE

M 50

MARINA 20

| | | | |
|--------------------|---------------------------|---------------------------|---------------------------|
| Monofásica | 200V-50Hz | 200V-50Hz | 12V |
| Caudal | 5.100L/H | 15.000L/H | 1.700L/H |
| Vel. Giro | 1.450 r.p.m | 1.450 r.p.m | 2.400 r.p.m |
| Potencia absorbida | 1 hp | 3 hp | 0,5 hp |
| Ø asp/imp | 40 mm | 50 mm | 20 mm |
| Embalaje | 320 x 150 x 210 mm | 400 x 170 x 240 mm | 250 x 120 x 150 mm |
| Peso | 11 kg | 22 kg | 6 kg |





APLICACIONES:

Idóneas para bombear vinos y mostos para desplazarlos de un sitio a otro en la bodega (trasiego), con la incorporación especial de un contador a través del cual podemos saber la cantidad trasegada.

ENOIL
-Roca-**ENOLOGÍA / Dispensers multiusos****PISTOLA DISPENSER**

PT 003806

Pistola de trasiego (uso alimentario)



PT 003802

Pistola de trasiego uso estandar (no alimentario)



PT 003805

Pistola de trasiego AUTOMATIK para combustibles (uso no alimentario)



| | | | |
|--------------------|-----------------|-----------------|-----------------|
| ØExterior boquilla | 24,50 mm | 24,50 mm | 24,50 mm |
| ØExterior manguera | | | 20 mm |
| ØInterior | 25mm/1" | 25mm/1" | 3/4" |
| Caudal máx | 75L | 75L | 60 L |
| Peso | 0,256 kg | 0,256 kg | 1,496 kg |

CMV 003702

Contador de vino



| | |
|----------------------|----------------|
| ØInterior | 3/4" G |
| Caudal mín/max | 28-80 L |
| Presión/ máx trabajo | 3 bar |
| Precisión | ± 1 % |
| Peso | 1,8 kg |

ES - CARACTERÍSTICAS
Totalizador de 6 cifras.

PT - CARACTERÍSTICAS
Totalizador de 6 cifras.

EN - FEATURES
6-digit totalizer..

FR - CARACTÉRISTIQUES
6 chiffres totalisateur.

ENOLMATIC**FABRICACIÓN POR ENCARGO**

Llenadora neumática



| | |
|--------------------|---|
| Producción de vino | 250 botellas/h |
| Alimentación | 220V/50-60 Hz 100-110V / 50-60Hz |
| Embalaje | 200 x 400 x 400 mm |
| Peso | 4 kg |

ES - CARACTERÍSTICAS

Botella: Ø interior cuello 16 a 28mm / H de 200 a 330 mm.

PT - CARACTERÍSTICAS

Garrafa: Ø gargalo de 16 a 28 mm / H de 200 a 330 mm.

EN - FEATURES

Bottle: Ø bottleneck from 16 to 28 mm / height from 200 to 330 mm.

FR - CARACTÉRISTIQUES

Bouteille: Ø goulet de 16 à 28 mm / H de 200 à 330 mm.

ENOLOGÍA / Embotelladora para vino

EMBOTELLADORA BAJA INOX

FABRICACIÓN POR ENCARGO

Por gravedad. Sin filtro y sin bomba

| | EBG 4B | EBG 6B |
|-----------------|---------------------------|---------------------------|
| Boquillas | 4 | 6 |
| Cap. de llenado | 0,25 a 5 L | 0,25 a 5 L |
| Depósito | 38 L | 57 L |
| Dimensiones | 600 x 500 x 910 mm | 900 x 500 x 910 mm |
| Peso | 30 kg | 40 kg |



ES - CARACTERÍSTICAS

Económica.
Boquillas articuladas para favorecer la introducción y la extracción de las botellas.
Válvula de flotador para control de llenado del depósito.
Bandeja portabotellas-recogegotas, regulable en altura.
Regulación de nivel de líquido en la botella.
Llave de vaciado total del depósito.

PT - CARACTERÍSTICAS

Económica.
Bicos articulados para favorecer a introdução e a extração das garrafas.
Válvula de flutuador para controlo de enchimento do depósito.
Tabuleiro portagarrafas-recolhe-gotas, regulável em altura.
Regulação de nível de líquido na garrafa.
Chave de esvaziamento total do depósito.

EN - FEATURES

Affordable.
Articulated nozzles to facilitate the introduction and extraction of the bottles.
Float valve to control the tank filling.
Bottle tray - height-adjustable drip tray.
Bottle liquid level regulation.
Tap for a complete tank draining.

FR - CARACTÉRISTIQUES

Économique.
Buses articulées pour permettre l'introduction et l'extraction des bouteilles.
Régleur à flotteur pour contrôler aisément le remplissage du réservoir. Plateau porte-bouteilles et d'égouttement, réglable en hauteur.
Réglage du niveau du liquide dans la bouteille.
Robinette de vidange totale du réservoir.



ENOLOGÍA / Embotelladora para vino
EMBOTELLADORA ALTA INOX
FABRICACIÓN POR ENCARGO

Por gravedad. Sin filtro y sin bomba

| | EAG 4B | EAG 6B |
|-----------------|-----------------------------|-----------------------------|
| Boquillas | 4 | 6 |
| Cap. de llenado | 0,25 a 5 L | 0,25 a 5 L |
| Depósito | 38 L | 57 L |
| Dimensiones | 600 x 500 x 1.600 mm | 900 x 500 x 1.600 mm |
| Peso | 34 kg | 46 kg |

ES - CARACTERÍSTICAS

Económica.
Boquillas articuladas para favorecer la introducción y la extracción de las botellas.
Válvula de flotador para control de llenado del depósito.
Bandeja portabotellas-recogegotas, regulable en altura.
Regulación de nivel de líquido en la botella.
Llave de vaciado total del depósito.

PT - CARACTERÍSTICAS

Económica.
Bicos articulados para favorecer a introdução e a extração das garrafas.
Válvula de flutuador para controlo de enchimento do depósito.
Tabuleiro portagarrafas-recolhe-gotas, regulável em altura.
Regulação de nível de líquido na garrafa.
Chave de esvaziamento total do depósito.

EN - FEATURES

Affordable.
Articulated nozzles to facilitate the introduction and extraction of the bottles.
Float valve to control the tank filling.
Bottle tray - height-adjustable drip tray.
Bottle liquid level regulation.
Tap for a complete tank draining.

FR - CARACTÉRISTIQUES

Économique.
Buses articulées pour permettre l'introduction et l'extraction des bouteilles.
Régleur à flotteur pour contrôler aisément le remplissage du réservoir. Plateau porte-bouteilles et d'égouttement, réglable en hauteur.
Réglage du niveau du liquide dans la bouteille.
Robinete vidange totale du réservoir.



ENOLOGÍA / Embotelladora para vino

1



2



EMBOTELLADORA ALTA INOX

FABRICACIÓN POR ENCARGO

Con bomba y filtro

1 EAG 4BBF

2 EAG 6BBF

| | | |
|-----------------|----------------------|----------------------|
| Boquillas | 4 | 6 |
| Cap. de llenado | 0,25 a 5 L | 0,25 a 5 L |
| Depósito | 38 L | 57 L |
| Dimensiones | 600 x 500 x 1.600 mm | 900 x 500 x 1.600 mm |
| Peso | 54 kg | 66 kg |



ES - CARACTERÍSTICAS

Boquillas articuladas para favorecer la introducción y la extracción de las botellas.

Válvula de flotador electrónico para control de llenado del depósito.

Bandeja portabotellas-recogegotas, regulable en altura.

Regulación de nivel de líquido en la botella.

Llave de vaciado total del depósito.

Bomba: 900 r.p.m

Incluye filtro de 20 placas en la versión de 4 boquillas y de 30 placas en la versión de 6 boquillas.

PT - CARACTERÍSTICAS

Bicos articulados para favorecer a introdução e a extração das garrafas.

Válvula de flutuador para controlo de enchimento do depósito.

Tabuleiro portagarrafas-recolhe-gotas, regulável em altura.

Regulação de nível de líquido na garrafa.

Chave de esvaziamento total do depósito.

Bomba: 900 r.p.m

Filtro 20 placas em 4 bicos e 30 placas em 6 bicos.

EN - FEATURES

Articulated nozzles to facilitate the introduction and extraction of the bottles.

Float valve to control the tank filling.

Bottle tray - height-adjustable drip tray.

Bottle liquid level regulation.

Tap for a complete tank draining.

Pump: 900 r.p.m

20 sheets in 4 nozzles and 30 sheets in 6 nozzles filter.

FFR - CARACTÉRISTIQUES

Buses articulées pour permettre l'introduction et l'extraction des bouteilles.

Régleur à flotteur pour contrôler aisément le remplissage du réservoir.

Plateau porte-bouteilles et d'égouttement, réglable en hauteur.

Réglage du niveau du liquide dans la bouteille.

Robinet de vidange totale du réservoir.

Pompe: 900 r.p.m

Filtre 20 plaques dans 4 buses et 30 plaques dans 6 buses.

EMBOTELLADORA ALTA INOX
FABRICACIÓN POR ENCARGO

Con bomba.

| | EAG 4BB | EAG 6BB |
|-----------------|----------------------------|----------------------------|
| Boquillas | 4 | 6 |
| Cap. de llenado | 0,25 a 5 L | 0,25 a 5 L |
| Depósito | 38 L | 57 L |
| Dimensiones | 600 x 500 x 1600 mm | 900 x 500 x 1600 mm |
| Peso | 44 kg | 56 kg |

ES - CARACTERÍSTICAS

Boquillas articuladas para favorecer la introducción y la extracción de las botellas.
 Válvula de flotador electrónico para control de llenado del depósito.
 Bandeja portabotellas-recogegotas, regulable en altura.
 Regulación de nivel de líquido en la botella.
 Llave de vaciado total del depósito.
 Bomba: 900 r.p.m

PT - CARACTERÍSTICAS

Bicos articulados para favorecer a introdução e a extração das garrafas.
 Válvula de flutuador para controlo de enchimento do depósito.
 Tabuleiro portagarrafas-recolhe-gotas, regulável em altura.
 Regulação de nível de líquido na garrafa.
 Chave de esvaziamento total do depósito.
 Bomba: 900 r.p.m

EN - FEATURES

Articulated nozzles to facilitate the introduction and extraction of the bottles.
 Float valve to control the tank filling.
 Bottle tray - height-adjustable drip tray.
 Bottle liquid level regulation.
 Tap for a complete tank draining.
 Pump: 900 r.p.m

FR - CARACTÉRISTIQUES

Buses articulées pour permettre l'introduction et l'extraction des bouteilles.
 Régleur à flotteur pour contrôler aisément le remplissage du réservoir. Plateau porte-bouteilles et d'égouttement, réglable en hauteur.
 Réglage du niveau du liquide dans la bouteille.
 Robinet de vidange totale du réservoir.
 Pompe: 900 r.p.m



ENOLOGÍA / Encorchadoras

EDH 750003

Encorchadora económica



Dimensiones

260 x 40 x 340 mm

Peso

1,10 kg



ES - CARACTERÍSTICAS

Manual / 2 Asas.

EN - FEATURES

Manual / 2 Draperies

PT - CARACTERÍSTICAS

Manual / 2 Asas.s.

FR - CARACTÉRISTIQUES

Manuelle / 2 Antlers



ETP 753801

Encorchadora económica



Dimensiones 450 x 150 x 700 mm

Peso 5,12 kg

ES - CARACTERÍSTICAS

Manual / 3 pies.

PT - CARACTERÍSTICAS

Manual / 3 pés.

EN - FEATURES

Manual / 3 feet.

FR - CARACTÉRISTIQUES

Manuelle / 3 pieds.





OLEOMAQUIA

APLICACIONES:

Tritura la aceituna de la forma más cómoda, eficaz y profesional. Tritura la aceituna hasta conseguir extraer el aceite de la misma. Uso particular y profesional.

OLEOMAQUIA / Molinos

MOLINO PR 25

Molino aceituna eléctrico.
Tolva en acero inoxidable.



| | |
|---------------|---------------------------|
| Monofásico | 220V-50Hz |
| Potencia | 1.500W / 2 hp |
| Producción | 300 kg/h |
| Medidas tolva | 445 x 310 x 215 mm |
| Peso | 30 kg |



PIE MOLINO ACEITUNA

Trípode acero inox
desmontable.



| | |
|-----|----------------------------|
| Ref | PIE MOLINO ACEITUNA |
|-----|----------------------------|



OLEOMAQUIA / Prensa hidráulica

OLEUM 50

Compuesto por: trituradora y prensa.



PRENSA ITALIA 300

Compuesta por bastidor de acero y plato prensador de acero inoxidable. Con bomba hidráulica manual y manómetro, una cesta con 50 capachos y 9 discos de acero inoxidable.

| | |
|-----------------|---------------------------------|
| Modelo | Prensa Italia 300 |
| Potencia molino | 1.5 kW |
| Producción | 60 - 100 kg/h producción |
| Presión prensa | 400 bar |
| Peso | 230 kg |
| Embalaje | 1.000 x 780 x 2.300 mm |



TRITURADORA OLIVAS 1

Construida en acero inoxidable Aisi 304. Compuesta de molino triturador, de cuba amasadora y de dosificador para depositar la masa de oliva en los capazos.

| | |
|-----------------|--|
| Modelo | Trituradora olivas 1 |
| Potencia molino | 2.2 kW / Cuba amasadora 0,55 kW |
| Producción | 80 - 100 kg/h producción |
| Presión prensa | |
| Peso | 98 kg |
| Embalaje | 1.400 x 850 x 1.650 mm |



OLEOMAQUIA / Prensa hidráulica

PRENSAS

PRENSA Ø40

Accionamiento manual-hidráulico
Incluye 12 capachetas de Ø400 mm

PRENSA Ø50

Accionamiento manual-hidráulico
Incluye 12 capachetas de Ø500 mm.
No incluye ruedas ni asas de transporte

PRENSA Ø60

Accionamiento manual-hidráulico
Incluye 12 capachetas de Ø600 mm. No incluye ruedas ni asas de transporte

| Ø Plato | 400 mm | 500 mm | 600 mm |
|------------|---------------------|---------------------|---------------------|
| Producción | +/- 2.5 por capacho | +/- 2.5 por capacho | +/- 2.5 por capacho |
| Presión | 15 t | 20 t | 20 t |
| Embalaje | 700 x 600 x 1500 mm | 700 x 600 x 1500 mm | 700 x 600 x 1500 mm |
| Peso | 100 kg | 100 kg | 100 kg |



CAPACHETA DE POLIPROPILENO

Uso alimentario - Fabricadas a mano

CAPACHETA Ø 40

CAPACHETA Ø 50

CAPACHETA Ø 60

| Dimensiones | Ø400mm Ext. Ø45mm Int. | Ø500mm Ext. Ø55mm Int. | Ø600mm Ext. Ø65mm Int. |
|-------------|---------------------------|---------------------------|---------------------------|
| Peso | ± -2,5 kg/masa | ± -3,5 kg/masa | ± -3,5 kg/masa |





ENOIL
-Roca

OLEOMAQUIA / Molinos

DEPÓSITOS FLOREADOS PARA ACEITE INOX 304

Depósitos con cierre neumático o cierre aceite

| DEPÓSITO | Ø | ALTURA | CAP | GRIFO | VÁLVULA |
|-----------------------|-------------------------|-------------------------|--------------|-------------------|-------------------|
| DEP 230 FLOR | 620 mm | 820 mm | 230 L | 1" | - |
| EQP. CIERRE NEUMÁTICO | TAPA | CÁMARA | BOMBÍN | GRIFO | VÁLVULA |
| REFERENCIA: | TN 595 | RA595 | O0500 | GRIFO L 1" | VAL 1" 1/4 |
| EQP. CIERRE ACEITE | TAPA ACEITE | TAPA POLVO | - | GRIFO | - |
| REFERENCIA: | TAC 200/300 ECON | TAP 200/300 ECON | - | GRIFO L 1" | - |
| DEPÓSITO | Ø | ALTURA | CAP | GRIFO | VÁLVULA |
| DEP 330 FLOR | 620 mm | 1.160 mm | 330 L | 1" | - |
| EQP. CIERRE NEUMÁTICO | TAPA | CÁMARA | BOMBÍN | GRIFO | VÁLVULA |
| REFERENCIA: | TN 595 | RA595 | O0500 | GRIFO L 1" | VAL 1" 1/4 |
| EQP. CIERRE ACEITE | TAPA ACEITE | TAPA POLVO | - | GRIFO | - |
| REFERENCIA: | TAC 200/300 ECON | TAP 200/300 ECON | - | GRIFO L 1" | - |
| DEPÓSITO | Ø | ALTURA | CAP | GRIFO | VÁLVULA |
| DEP 420 FLOR | 750 mm | 1.020 mm | 420 L | 1" | - |
| EQP. CIERRE NEUMÁTICO | TAPA | CÁMARA | BOMBÍN | GRIFO | VÁLVULA |
| REFERENCIA: | TN 720 | RA720 | O0500 | GRIFO L 1" | VAL 1" 1/4 |
| EQP. CIERRE ACEITE | TAPA ACEITE | TAPA POLVO | - | GRIFO | - |
| REFERENCIA: | TAC 420/530/640 | TAP 420/530/640 | - | GRIFO L 1" | - |
| DEPÓSITO | Ø | ALTURA | CAP | GRIFO | VÁLVULA |
| DEP 530 FLOR | 750 mm | 1.270 mm | 530 L | 1" | - |
| EQP. CIERRE NEUMÁTICO | TAPA | CÁMARA | BOMBÍN | GRIFO | VÁLVULA |
| REFERENCIA: | TN 720 | RA720 | O0500 | GRIFO L 1" | VAL 1" 1/4 |
| EQP. CIERRE ACEITE | TAPA ACEITE | TAPA POLVO | - | GRIFO | - |
| REFERENCIA: | TAC 420/530/640 | TAP 420/530/640 | - | GRIFO L 1" | - |
| DEPÓSITO | Ø | ALTURA | CAP | GRIFO | VÁLVULA |
| DEP 800 FLOR | 940 mm | 1.520 mm | 800 L | 1" | - |
| EQP. CIERRE NEUMÁTICO | TAPA | CÁMARA | BOMBÍN | GRIFO | VÁLVULA |
| REFERENCIA: | TN 915 | RA915 | O0500 | GRIFO L 1" | VAL 1" 1/4 |
| EQP. CIERRE ACEITE | TAPA ACEITE | TAPA POLVO | - | GRIFO | - |
| REFERENCIA: | TAC 800/1000 | TAP 800/1000 | - | GRIFO L 1" | - |



DEPÓSITOS FLOREADOS INOX 304 E SERIE "ECO"

Depósitos siempre llenos con cierre neumático o con cierre de aceite.

| DEPÓSITO | Ø | ALTURA | CAP | GRIFO | VÁLVULA |
|-----------------------|-------------------------|--------------------------|--------------|--------------------------|-------------------|
| DEP 100 FLOR ECON | 455 mm | 680 mm | 100 L | 1/2" | - |
| EQP. CIERRE NEUMÁTICO | TAPA | CÁMARA | BOMBÍN | GRIFO | VÁLVULA |
| REFERENCIA: | TN 437 | RA437 | O0500 | GRIFO 1/2" L ECON | VAL 1" 1/4 |
| EQP. CIERRE ACEITE | TAPA ACEITE | TAPA POLVO | - | GRIFO | - |
| REFERENCIA: | TAC 100/150A ECO | TAP 100/150A ECON | - | GRIFO 1/2" L ECON | - |
| DEPÓSITO | Ø | ALTURA | CAP | GRIFO | VÁLVULA |
| DEP 150 A FLOR ECON | 455 mm | 965 mm | 150 L | 1/2" | - |
| EQP. CIERRE NEUMÁTICO | TAPA | CÁMARA | BOMBÍN | GRIFO | VÁLVULA |
| REFERENCIA: | TN 437 | RA437 | O0500 | GRIFO 1/2" L ECON | VAL 1" 1/4 |
| EQP. CIERRE ACEITE | TAPA ACEITE | TAPA POLVO | - | GRIFO | - |
| REFERENCIA: | TAC 100/150A ECO | TAP 100/150A ECON | - | GRIFO 1/2" L ECON | - |
| DEPÓSITO | Ø | ALTURA | CAP | GRIFO | VÁLVULA |
| DEP 200 A FLOR ECO | 530 mm | 980 mm | 200 L | 1/2" | - |
| EQP. CIERRE NEUMÁTICO | TAPA | CÁMARA | BOMBÍN | GRIFO | VÁLVULA |
| REFERENCIA: | TN 520 | RA520 | O0500 | GRIFO 1/2" L ECON | VAL 1" 1/4 |
| EQP. CIERRE ACEITE | TAPA ACEITE | TAPA POLVO | - | GRIFO | - |
| REFERENCIA: | TAC 150B/200A | TAP 150B/200A | - | GRIFO 1/2" L ECON | - |
| DEPÓSITO | Ø | ALTURA | CAP | GRIFO | VÁLVULA |
| DEP 200 B FLOR ECO | 630 mm | 690 mm | 200 L | 1/2" | - |
| EQP. CIERRE NEUMÁTICO | TAPA | CÁMARA | BOMBÍN | GRIFO | VÁLVULA |
| REFERENCIA: | TN 610 | RA610 | O0500 | GRIFO 1/2" L ECON | VAL 1" 1/4 |
| EQP. CIERRE ACEITE | TAPA ACEITE | TAPA POLVO | - | GRIFO | - |
| REFERENCIA: | TAC 200/300 ECON | TAP 200/300 ECON | - | GRIFO 1/2" L ECON | - |

OLEOMAQUIA / Depósitos

| DEPÓSITO | Ø | ALTURA | CAP | GRIFO | VÁLVULA |
|-----------------------|-------------------------|-------------------------|---------------|--------------------------|-------------------|
| DEP 300 FLOR ECON | 630 mm | 990 mm | 300 L | 3/4" | - |
| EQP. CIERRE NEUMÁTICO | TAPA | CÁMARA | BOMBÍN | GRIFO | VÁLVULA |
| REFERENCIA: | TN 610 | RA610 | O0500 | GRIFO 3/4" L ECON | VAL 1" 1/4 |
| EQP. CIERRE ACEITE | TAPA ACEITE | TAPA POLVO | - | GRIFO | - |
| REFERENCIA: | TAC 200/300 ECON | TAP 200/300 ECON | - | GRIFO 3/4" L ECON | - |
| DEPÓSITO | Ø | ALTURA | CAP | GRIFO | VÁLVULA |
| DEP 400 FLOR ECON | 710 mm | 1.045 mm | 400 L | 3/4" | - |
| EQP. CIERRE NEUMÁTICO | TAPA | CÁMARA | BOMBÍN | GRIFO | VÁLVULA |
| REFERENCIA: | TN 695 | RA695 | O0500 | GRIFO 3/4" L ECON | VAL 1" 1/4 |
| EQP. CIERRE ACEITE | TAPA ACEITE | TAPA POLVO | - | GRIFO | - |
| REFERENCIA: | TAC 400 ECON | TAP 400 ECON | - | GRIFO 3/4" L ECON | - |
| DEPÓSITO | Ø | ALTURA | CAP | GRIFO | VÁLVULA |
| DEP 500 FLOR ECON | 780 mm | 1.100 mm | 500 L | 3/4" | - |
| EQP. CIERRE NEUMÁTICO | TAPA | CÁMARA | BOMBÍN | GRIFO | VÁLVULA |
| REFERENCIA: | TN 770 | RA770 | O0500 | GRIFO 3/4" L ECON | VAL 1" 1/4 |
| EQP. CIERRE ACEITE | TAPA ACEITE | TAPA POLVO | - | GRIFO | - |
| REFERENCIA: | TAC 500/600 ECON | TAP 500/600 ECON | - | GRIFO 3/4" L ECON | - |
| DEPÓSITO | Ø | ALTURA | CAP | GRIFO | VÁLVULA |
| DEP 600 FLOR ECON | 780 mm | 1.240 mm | 600 L | 1" | - |
| EQP. CIERRE NEUMÁTICO | TAPA | CÁMARA | BOMBÍN | GRIFO | VÁLVULA |
| REFERENCIA: | TN 770 | RA770 | O0500 | GRIFO L 1" | VAL 1" 1/4 |
| EQP. CIERRE ACEITE | TAPA ACEITE | TAPA POLVO | - | GRIFO | - |
| REFERENCIA: | TAC 500/600 ECON | TAP 500/600 ECON | - | GRIFO L 1" | - |
| DEPÓSITO | Ø | ALTURA | CAP | GRIFO | VÁLVULA |
| DEP 1000 FLOR ECON | 1025 mm | 1.240 mm | 1000 L | 1" | - |
| EQP. CIERRE NEUMÁTICO | TAPA | CÁMARA | BOMBÍN | GRIFO | VÁLVULA |
| REFERENCIA: | TN 990 | RA990 | O0500 | GRIFO L 1" | VAL 1" 1/4 |
| EQP. CIERRE ACEITE | TAPA ACEITE | TAPA POLVO | - | GRIFO | - |
| REFERENCIA: | TAC 1000 ECON | TAP 1000 ECON | - | GRIFO L 1" | - |

APLICACIONES:

Perfectos para la fermentación, elaboración y conservación de vinos o cualquier tipo de líquido alimentario, sidra, licores, aguardientes, miel, agua, etc.

OLEOMAQUIA / Depósitos



DEPÓSITOS FLOREADOS PARA ACEITE INOX 316

Depósitos siempre llenos con cierre neumático o con cierre de aceite.

| DEPÓSITO | Ø | ALTURA | CAP | GRIFO | VÁLVULA |
|-----------------------|-------------------------|-------------------------|--------------|-------------------|-------------------|
| DEP 230 C | 620 mm | 820 mm | 230 L | 1" | - |
| EQP. CIERRE NEUMÁTICO | TAPA | CÁMARA | BOMBÍN | GRIFO | VÁLVULA |
| REFERENCIA: | TN 595 | RA595 | O0500 | GRIFO L 1" | VAL 1" 1/4 |
| EQP. CIERRE ACEITE | TAPA ACEITE | TAPA POLVO | - | GRIFO | - |
| REFERENCIA: | TAC 200/300 ECON | TAP 200/300 ECON | - | GRIFO L 1" | - |
| DEPÓSITO | Ø | ALTURA | CAP | GRIFO | VÁLVULA |
| DEP 420 C | 750 mm | 1.020 mm | 420 L | 1" | - |
| EQP. CIERRE NEUMÁTICO | TAPA | CÁMARA | BOMBÍN | GRIFO | VÁLVULA |
| REFERENCIA: | TN 720 | RA720 | O0500 | GRIFO L 1" | VAL 1" 1/4 |
| EQP. CIERRE ACEITE | TAPA ACEITE | TAPA POLVO | - | GRIFO | - |
| REFERENCIA: | TAC 420/530/640 | TAP 420/530/640 | - | GRIFO L 1" | - |
| DEPÓSITO | Ø | ALTURA | CAP | GRIFO | VÁLVULA |
| DEP 530 C | 750 mm | 1.270 mm | 530 L | 1" | - |
| EQP. CIERRE NEUMÁTICO | TAPA | CÁMARA | BOMBÍN | GRIFO | VÁLVULA |
| REFERENCIA: | TN 720 | RA720 | O0500 | GRIFO L 1" | VAL 1" 1/4 |
| EQP. CIERRE ACEITE | TAPA ACEITE | TAPA POLVO | - | GRIFO | - |
| REFERENCIA: | TAC 420/530/640 | TAP 420/530/640 | - | GRIFO L 1" | - |

APLICACIONES:

Perfectos para la fermentación, elaboración y conservación de vinos o cualquier tipo de líquido alimentario, sidra, licores, aguardientes, miel, agua, etc.

ENOIL

OLEOMAQUIA / Depósitos

DEPÓSITOS DECANTACIÓN PARA ACEITE INOX 304

| DEPÓSITO | Ø | ALTURA | CAP | GRIFO |
|-----------------------|--------------------------|---------------|--------------|--------------------------|
| DECANTADOR 75 FLOREC | 370 mm | 745 mm | 75 L | 1/2" |
| EQP. CIERRE ACEITE | TAPA POLVO | - | - | GRIFO |
| REFERENCIA: | TAP 50/75 ECON | - | - | GRIFO 1/2" L ECON |
| DEPÓSITO | Ø | ALTURA | CAP | GRIFO |
| DECANTADOR 100 FLOREC | 470 mm | 800 mm | 100 L | 1/2" |
| EQP. CIERRE ACEITE | TAPA POLVO | | | GRIFO |
| REFERENCIA: | TAP 100/150A ECON | - | - | GRIFO 1/2" L ECON |

APLICACIONES:

Perfectos para la fermentación, elaboración y conservación de vinos o cualquier tipo de líquido alimentario, sidra, licores, aguardientes, miel, agua, etc.



DEPÓSITOS FLOREADOS PARA ACEITE INOX 304

Depósitos fondo cónico, patas.

| DEPÓSITO | Ø | ALTURA | CAP | GRIFO | VÁLVULA | - |
|-----------------------|-------------------------|--------------------------|--------------|--------------------------|-------------------|----------------------------|
| DEP 100 FLOR FCPS | 470 mm | 1000 mm | 100 L | 1/2" | - | - |
| EQP. CIERRE NEUMÁTICO | TAPA | CÁMARA | BOMBÍN | GRIFO | VÁLVULA | VÁLVULA ESFÉRICA |
| REFERENCIA: | TN 420 | RA420 | 00500 | GRIFO 1/2" L ECON | VAL 1" 1/4 | LIMPIADOR IMPUREZAS |
| EQP. CIERRE ACEITE | TAPA ACEITE | TAPA POLVO | - | GRIFO | - | VÁLVULA ESFÉRICA |
| REFERENCIA: | - | TAP 100/150A ECON | - | GRIFO 1/2" L ECON | - | LIMPIADOR IMPUREZAS |
| DEPÓSITO | Ø | ALTURA | CAP | GRIFO | VÁLVULA | - |
| DEP 230 FLOR FCPS | 620 mm | 1000 mm | 230 L | 1" | - | - |
| EQP. CIERRE NEUMÁTICO | TAPA | CÁMARA | BOMBÍN | GRIFO | VÁLVULA | VÁLVULA ESFÉRICA |
| REFERENCIA: | TN 595 | RA595 | 00500 | GRIFO L 1" | VAL 1" 1/4 | LIMPIADOR IMPUREZAS |
| EQP. CIERRE ACEITE | TAPA ACEITE | TAPA POLVO | - | GRIFO | - | VÁLVULA ESFÉRICA |
| REFERENCIA: | TAC 200/300 ECON | TAP 200/300 ECON | - | GRIFO L 1" | - | LIMPIADOR IMPUREZAS |
| DEPÓSITO | Ø | ALTURA | CAP | GRIFO | VÁLVULA | - |
| DEP 330 FLOR FCPS | 620 mm | 1.500 mm | 330 L | 1" | - | - |
| EQP. CIERRE NEUMÁTICO | TAPA | CÁMARA | BOMBÍN | GRIFO | VÁLVULA | VÁLVULA ESFÉRICA |
| REFERENCIA: | TN 595 | RA595 | 00500 | GRIFO L 1" | VAL 1" 1/4 | LIMPIADOR IMPUREZAS |
| EQP. CIERRE ACEITE | TAPA ACEITE | TAPA POLVO | - | GRIFO | - | VÁLVULA ESFÉRICA |
| REFERENCIA: | TAC 200/300 ECON | TAP 200/300 ECON | - | GRIFO L 1" | - | LIMPIADOR IMPUREZAS |

*H PATAS 400 mm excepto DEPTP 1000 FLOR FCPS (470 mm)

| DEPÓSITO | Ø | ALTURA | CAP | GRIFO | VÁLVULA | - |
|-----------------------|------------------------|------------------------|---------------|-------------------|-------------------|----------------------------|
| DEP 420 FLOR FCPS | 750 mm | 1.400 mm | 530 L | 1" | - | - |
| EQP. CIERRE NEUMÁTICO | TAPA | CÁMARA | BOMBÍN | GRIFO | VÁLVULA | VÁLVULA ESFÉRICA |
| REFERENCIA: | TN 720 | RA720 | O0500 | GRIFO L 1" | VAL 1" 1/4 | LIMPIADOR IMPUREZAS |
| EQP. CIERRE ACEITE | TAPA ACEITE | TAPA POLVO | - | GRIFO | - | VÁLVULA ESFÉRICA |
| REFERENCIA: | TAC 420/530/640 | TAP 420/530/640 | - | GRIFO L 1" | - | LIMPIADOR IMPUREZAS |
| DEPÓSITO | Ø | ALTURA | CAP | GRIFO | VÁLVULA | - |
| DEP 530 FLOR FCPS | 750 mm | 1.650 mm | 530 L | 1" | - | - |
| EQP. CIERRE NEUMÁTICO | TAPA | CÁMARA | BOMBÍN | GRIFO | VÁLVULA | VÁLVULA ESFÉRICA |
| REFERENCIA: | TN 720 | RA720 | O0500 | GRIFO L 1" | VAL 1" 1/4 | LIMPIADOR IMPUREZAS |
| EQP. CIERRE ACEITE | TAPA ACEITE | TAPA POLVO | - | GRIFO | - | VÁLVULA ESFÉRICA |
| REFERENCIA: | TAC 420/530/640 | TAP 420/530/640 | - | GRIFO L 1" | - | LIMPIADOR IMPUREZAS |
| DEPÓSITO | Ø | ALTURA | CAP | GRIFO | VÁLVULA | - |
| DEP 1000 FLOR FCPS | 1.020 mm | 1.670 mm | 1000 L | 1" | - | - |
| EQP. CIERRE NEUMÁTICO | TAPA | CÁMARA | BOMBÍN | GRIFO | VÁLVULA | VÁLVULA ESFÉRICA |
| REFERENCIA: | TN 990 | RA990 | O0500 | GRIFO L 1" | VAL 1" 1/4 | LIMPIADOR IMPUREZAS |
| EQP. CIERRE ACEITE | TAPA ACEITE | TAPA POLVO | - | GRIFO | - | VÁLVULA ESFÉRICA |
| REFERENCIA: | TAC 1000 ECON | TAP 1000 ECON | - | GRIFO L 1" | VAL 1" 1/4 | LIMPIADOR IMPUREZAS |

APLICACIONES:

Los filtros como su nombre indica se utilizan para el filtrado y clarificación de numerosos líquidos.

OLEOMAQUIA / Filtros



FCOLB 18PV OIL

Serie Colombo Filtro 18 placas con bomba "RP autoaspirante"



FCOLB 36PV OIL

Serie Colombo Filtro 36 placas con bomba "RP autoaspirante"

| | | |
|------------|---------------------------|----------------------------|
| Superficie | 20 x 20 cm | 20 x 20 cm |
| L.aceite/h | 200 ÷ 300 | 550 ÷ 800 |
| P. motor | 0,9 hp | 0,6 hp |
| Embalaje | 450 x 270 x 280 mm | 1000 x 270 x 800 mm |
| Peso | 19 kg | 35 kg |





ENOIL

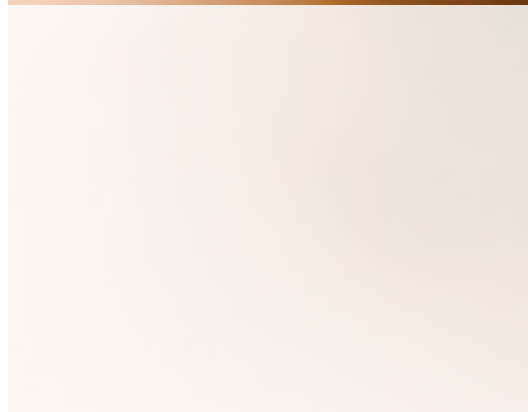

OLEOMAQUIA / Filtros



FJOLB 10PV OIL
Serie Jolly. Filtro 10
placas con bomba "RP
autoaspirante"



FJOLB 20PV OIL
Serie Jolly. Filtro 20
placas con bomba "RP
autoaspirante"

| | | |
|------------|---------------------------|---------------------------|
| Superficie | 20 x 20 cm | 20 x 20 cm |
| L.aceite/h | 200 ÷ 500 | 400 ÷ 800 |
| P. motor | Z25 | Z25 |
| Embalaje | 500 x 400 x 570 mm | 650 x 400 x 570 mm |
| Peso | 30 kg | 38 kg |



PLACAS FILTRANTES 20X20

20x20 cm PAQUETES 25 UD

Ref: **SA050-20**

Características: **Placas filtrantes de celulosa**

Aplicación: **Aceite**

*Precio por unidad

OLEOMAQUIA / LLenadoras y embotelladora

EMBOTELLADORA ALTA INOX

FABRICACIÓN POR ENCARGO

Embotelladora SPEEDY OLIO. Monofásica c/bomba "Vacuum System"



SPEEDY OLIO 2B



SPEEDY OLIO 4B



SPEEDY OLIO 6B

| | | | |
|-----------------|---------------------------|----------------------------|-----------------------------|
| Nº Boq./ Ø | 2 - Ø14 | 4 - Ø14 | 6 - Ø14 |
| Producción | 120L/h | 350L/h | 500L/h |
| Cap. de llenado | 0,25 a 5 L | 0,25 a 5 L | 0,25 a 5 L |
| Dimensiones | 620 x 450 x 700 mm | 900 x 450 x 1500 mm | 1100 x 450 x 1500 mm |
| Peso | 45 kg | 65 kg | 80 kg |





APICULTURA

APICULTURA / depósitos, trípodes y grifos



Depósitos con fondo plano.

GRIFOS



REF



Características

GRIFO MIEL

Mangüito Ø40

DEPÓSITOS FLOREADOS PARA MIEL EN INOX 304

| DEPÓSITO | Ø | ALTURA | CAP | |
|------------------|--------------------------|-------------------|---------------|--|
| DEP MIEL 50 S/G | 300 mm | 545 mm | 50 KG | |
| EQUIP. CIERRE | TAPA POLVO | GRIFO | - | |
| REFERENCIA: | TAP 30 ECON | GRIFO MIEL | - | |
| DEPÓSITO | Ø | ALTURA | CAP | |
| DEP MIEL 100 S/G | 370 mm | 685 mm | 100 KG | |
| EQUIP. CIERRE | TAPA POLVO | GRIFO | - | |
| REFERENCIA: | TAP 50/75 ECON | GRIFO MIEL | - | |
| DEPÓSITO | Ø | ALTURA | CAP | |
| DEP MIEL 200 S/G | 455 mm | 965 mm | 200 KG | |
| EQUIP. CIERRE | TAPA POLVO | GRIFO | - | |
| REFERENCIA: | TAP 100/150A ECON | GRIFO MIEL | - | |
| DEPÓSITO | Ø | ALTURA | CAP | |
| DEP MIEL 400 S/G | 630 mm | 990 mm | 400 KG | |
| EQUIP. CIERRE | TAPA POLVO | GRIFO | - | |
| REFERENCIA: | TAP 200/300 ECON | GRIFO MIEL | - | |

TRÍPODES PARA DEPÓSITOS PARA MIEL EN INOX

| REF | DEPÓSITO CORRESPONDIENTE | Ø | |
|------------------|--------------------------|---------------|--|
| PIE 50/75 ECO | DEP MIEL 100 | 370 mm | |
| PIE 100/150A ECO | DEP MIEL 200 | 455 mm | |
| PIE 200B/300 ECO | DEP MIEL 400 | 630 mm | |
| PIE 400 ECO | DEP MIEL 520 | 710 mm | |

CONDICIONES GENERALES DE VENTA

INFORMACIÓN TÉCNICA

1º. La información técnica y fotografías contenida en esta tarifa son de carácter orientativo, por ello, Ausavil se reserva el derecho a modificar sin previo aviso el aspecto final, las características técnicas y los precios, con el fin de ajustarse a las contantes mejoras que puedan afectar a nuestros productos.

PEDIDOS

1º. Solo se tramitarán los pedidos recibidos por E-mail, Whatsapp y B2B
2º. Ciertos artículos de esta tarifa se trabajarán solamente bajo pedido.

PRECIO

1º. Los precios y características de la presente tarifa son orientativos para la venta al público.
2º. Para artículos de fabricación por encargo, se requiere un 30 % del pago, por adelanto y no se admiten devolución.
3º. Los portes y embalajes siempre serán incluidos en factura, separados del precio de la mercancía, excepto en condiciones acordadas
4º Para pedidos inferiores a 30€, no se aplicarán descuentos y se cargarán 6€ en concepto de gastos de embalaje y manipulación.
5º. AUSAVIL se reserva el derecho a modificar los precios sin previo aviso al cliente.

CONDICIONES DE PAGO

1º. Ausavil realiza la facturación quincenalmente. La factura especificará detalladamente la forma de pago, vencimiento, descuentos, etc..
2º. Las notas de abono serán deducidas de las facturas pendientes de vencimiento
3º. Las condiciones de pago serán las siguientes:
•Pedidos inferiores a 1.000 €, giro a 30 días.
•Pedidos superiores a 1.000 €, opcional giro a 30-60 días.
•Pago anticipado, descuento del 2% de pronto pago.
4º. En caso de recibos impagados, será bloqueado el suministro de mercancía, procediendo al mismo tiempo, a tramitar las acciones legales pertinentes.

CONDICIONES DE ENTREGA

1º. Las condiciones de entrega serán las siguientes:

PEDIDOS DE ALMACÉN*:

•Pedidos inferiores a 600 €, portes en factura.
•Pedidos superiores a 600 € portes pagados. Excepto Baleares y Canarias.
•En todos los pedidos de depósitos el porte irá en factura, independientemente del importe del pedido.

PEDIDOS DE RECAMBIOS*:

•Pedidos inferiores a 300 €, portes en factura.
•Pedidos superiores a 300 € portes pagados. Excepto Baleares y Canarias

| | |
|---|-----------|
| GALICIA | 7 € |
| PENÍNSULA Y PORTUGAL | 18 € |
| BALEARES | 30 € |
| CANARIAS, CEUTA, Y MELILLA | CONSULTAR |
| *Los precios indicados en estas condiciones de venta no incluyen el IVA | |

CONDICIONES GENERALES DE VENTA

RECLAMACIONES

1º. Cualquier tipo de reclamación de transporte ha de realizarse en el momento de la descarga, Ausavil no se hará cargo de ninguna reclamación debida a daños de transporte. Para daños derivados por el traslado, el plazo para reclamaciones es de 24h. desde la recepción de la mercancía. El tiempo de reposición, será variable según el tipo de producto.

DEVOLUCIONES

1º. No se admiten devoluciones una vez transcurridos 15 días de la fecha de suministro.

2º. Para las devoluciones que se hagan dentro de dicho plazo, los portes serán siempre por parte del cliente.

3º. Es obligatorio, para cualquier tipo de devolución, presentar el albarán o factura de compra. En caso de no recibir dicha documentación junto con la mercancía no se procederá a ejecutar la devolución.

GARANTÍAS

1º. Para cualquier reclamación en garantía es obligatorio rellenar y firmar la ficha de solicitud de reparación en garantía. Esta ficha será suministrada por nuestro personal del servicio postventa vía e-mail o lo podrá tramitar vía B2B. En caso de no cubrirla, Ausavil no efectuará la tramitación de dicha garantía.

2º. Todos los materiales y su transporte serán con cargo y se extenderá la factura oportuna. Posteriormente, una vez verificada la garantía por nuestros técnicos especializados, AUSAVIL abonará dichos materiales o repondrá gratis las piezas, de no haberse suministrado.

3º. Los portes correspondientes a las reparaciones en garantía se cobrarán de la siguiente manera:

| | |
|---|-----------|
| GALICIA | 4 € |
| PENÍNSULA Y PORTUGAL | 7 € |
| BALEARES | 13 € |
| CANARIAS, CEUTA, Y MELILLA | CONSULTAR |
| *Los precios indicados en estas condiciones de venta no incluyen el IVA | |

NOTAS

NOTAS

NOTAS

NOTAS

NOTAS

AUSAVIL

custom-made machines

**LG. A BREA, 15
36689 - MATALOBOS - A ESTRADA
PONTEVEDRA**

www.ausavil.com - info@ausavil.com - 986 585 750